

## TECHNICAL TERMS

**1. ESTIMATE:**An estimate is the anticipated or probable cost of work and is usually prepared before the construction is taken up. It is indeed calculations or computations of various items of an engineering work.

**2. QUANTITY SURVEY:** It is the schedule of all items of work in a building. These quantities are calculated from the drawing of the building. Thus quantity survey gives quantities of work done in case of each items, when priced gives the total cost. In short, quantity survey means calculations of quantities of materials required to complete the work concerned

**3.SPECIFICATIONS :**Detailed specifications gives the nature, quality and class of work, materials to be used in the various parts of work , quality of the material, their proportions, method of preparation, workmanship and description of execution of work are required.

**4.RATES :**The rates of various items of works, materials to be used in the construction and the wages of different categories of labor (skilled and unskilled) should be available for preparing an estimate. The cost of transportation charges should also be known. As far as possible sanctioned "Schedule of Rates" shall be followed or the rates may be worked out by the "Analysis of Rates" method.

**5.SITE PLAN:** It is the plan drawn for a particular construction showing its position with respect to approaching roads, main bazars, markets and other permanent features in a populated area. It shows the location of the area under construction with respect to the other areas and on it generally the names of the owners of areas or property holders adjoining to it are also denoted. North line is also clearly marked on it.

**6. LINE PLAN** Line plan can be defined as the plan of a particular construction simply showing main features with the help of the single lines of different portions of the constructions. Details of constructions are not generally shown on this plan. This inside and outside dimensions shown on this plan should necessarily be corresponding to actual dimensions.

**7. INDEX PLAN :**This is the plan of a particular colony showing the positions of different houses in single lines their number if any position of roads, schools, market, hospitals and other features etc. this plan is generally fixed on the entrance, or at exit or in the central place of the colony, for the guidance of the inhabitants and outsiders.

---

showing all detailed information required for its execution. Various sections and elevations are clearly drawn on this plan.

**CENTRE LINE PLAN :** This is actually a layout plan drawn to facilitate the laying out of foundation lines and other features. It is generally fixed on the entrance or at exit in the central place of the colony for the guidance of the inhabitants and outsiders.

**SUPPLEMENTARY ESTIMATE:** When some additions are done in the original work, a fresh detailed estimate is prepared to supplement the original work. This estimate is called supplementary estimate. It is also accompanied by all the papers as required in thru detailed estimate.

**ADMINISTRATIVE APPROVAL:** For any project required by the department an approval so sanction of the competent authority with respect to the cost and work is necessary at the first instance. Thus administrative approval denotes the formal acceptance by the administrative department concerned of the proposals for incurring expenditure.

**TECHNICAL SANCTION :**It means the sanction and order by the competent authority of the department for the detailed estimate design calculations quantities of work rates and cost of work..after the technical sanction of the estimate is received the work is then taken up for construction.

**COMPETENT AUTHORITY:** An officer or any other authority in the department to whom relevant powers are delegated by the government (Financial Department).

**ORDINARY MEASUREMENT BOOK:** It is measured book in which entries regarding the work done or supplies made and services performed are recorded for the purpose of making payments to the contractors or the labor. Entries in the M.B are generally recorded by the sectional officers or by any other officers deputed for the purpose

## **LUMPSUM ITEMS**

Sometimes while preparing estimate for the certain small items like front architecture or decoration work of a building it is not possible to workout detailed quantities so far such lump sum items a lump sum rate is provided.

## **PLINTH AREA**

The built up covered area of a building measured at floor level of any storey is called plinth area.

## **17. CIRCULATION AREA**

The total cost of construction including all expenditures incurred plus the cost of external services up to the end of the completion of the work is called capital cost. It also includes the cost of preliminary works, miscellaneous items and supervision charges etc.

### **1.1 GENERAL**

Estimating is the technique of calculating or computing the various quantities and the expected Expenditure to be incurred on a particular work or project. In case the funds available are less than the estimated cost the work is done in part or by reducing it or specifications are altered, the following requirements are necessary for preparing an estimate.

1. Drawings like plan, elevation and sections of important points.
2. Detailed specifications about workmanship & properties of materials etc.
3. Standard schedule of rates of the current year.

### **1.2 UNITS OF MEASUREMENTS**

The units of measurements are mainly categorized for their nature, shape and size and for making payments to the contractor and also. The principle of units of measurements normally consists the following:

- a) Single units work like doors, windows, trusses etc., is expressed in numbers.
- b) Works consists linear measurements involve length like cornice, fencing, hand rail, bands of specified width etc., are expressed in running meters (RM)
- c) Works consists areal surface measurements involve area like plastering, white washing, partitions of specified thickness etc., and are expressed in square meters (m<sup>2</sup>)
- d) Works consists cubical contents which involve volume like earth work, cement concrete, Masonry etc are expressed in Cubic metres.

[BASED ON IS 1200 REVISED]

Sl. No.	Particulars of item	Units of Measurement	Units of payment
I	<b>Earth work:</b>		
	1. Earth work in Excavation	cum	Per%cum
	2. Earthwork in filling in foundation trenches	cum	Per%cum
II	3. Earth work in filling in plinth	cum	Per%cum
	<b>Concrete:</b>		
	1. Lime concrete in foundation	cum	percum
	2. Cement concrete in Lintels	cum	percum
	3. R.C.C. in slab	cum	percum
III	6. Cement concrete bed	cum	per cum
	7. R.C. Sunshade (Specified Width & Hight)	cum	lrm
IV	<b>Damp Proof Course (D.P.C)</b> (Thickness should be mentioned)	sqm	persqm
V	<b>Brick work:</b>		
	1. Brickwork in foundation	cum	percum
	2. Brick work in plinth	cum	percum
	3. Brick work in super structure	cum	percum
	4. Thin partition walls	sqm	percum
	5. Brick work in arches	cum	percum
VI	6. Reinforced brick work (R.B. Work)	cum	percum
	<b>Stone Work:</b>		
	Stone masonry	cum	percum
VII	<b>Wood work:</b>		
	1. Door and windows frames or chowkhats, rafters beams	cum	percum
	2. Shutters of doors and windows (thickness specified)	sqm	persqm
	3. Doors and windows fittings (like hinges, tower bolts, sliding bolts, handles)	Number	per number
VII	<b>Steel work</b>		
	1. Steel reinforcement bars etc in R.C.C. and R.B. work quintal	Quintal	per quintal
	2. Bending, binding of steel Reinforcement	Quintal	per quintal
	3. Rivets, bolts, & nuts, Anchor bolts, Lewis bolts, Holding down bolts.	Quintal	per quintal
	4. Iron hold fasts	Quintal	per quintal
	5. Iron railing (height and types specified)	Quintal	per quintal
	6. Iron grills	sqm	per sqm

VIII	<b>Roofing</b>		
	1. R.C.C. and R.B. Slab roof (excluding steel)	cum	per cum
	2. L.C. roof over and inclusive of tiles or brick or stone slab etc (thickness specified)	sqm	per sqm
	3. Centering and shuttering form work	sqm	per sqm

VIII	<b>Roofing</b>		
	1. R.C.C. and R.B.Slab roof (excluding steel)	cum	per cum
	2. L.C. roof over and inclusive of tiles or brick or stone slab etc (thickness specified)	sqm	per sqm
	3. Centering and shuttering form work	sqm	per sqm
	4. A.C. Sheet roofing	sqm	per sqm
IX	<b>Plastering, points&amp; finishing</b>		
	1. Plastering-Cement or Lime Mortar (thickness and proportion specified)	sqm	per sqm
	2. Pointing	sqm	per sqm
	3. White washing, colour washing, cement wash (number of coats specified)	sqm	per sqm
	4. Distemping (number of coats specified)	sqm	per sqm
	5. Painting, varnishing (number of coats specified)	sqm	per sqm
X	<b>Flooring</b>		
	1. 25mm cement concrete over 75mm lime concrete floor (including L.C.)	sqm	per sqm
	2. 25mm or 40mm C.C. floor	sqm	per sqm
	3. Doors and window sills (C.C. or cement mortar plain)	sqm	per sqm
XI	<b>Rain water pipe /Plain pipe</b>	1RM	per RM
XII	<b>Steel wooden trusses</b>	1No	per 1No
XIII	<b>Glass pannels(supply)</b>	sqm	per sqm
XIV	<b>Fixing of glass panels or cleaning</b>	No	per no.

### 1.3.2 DATA REQUIRED TO PREPARE AN ESTIMATE

1. Drawings i.e. plans, elevations, sections etc.

7

---

2. Specifications.

3. Rates.

### 1.3.3 DRAWINGS

If the drawings are not clear and without complete dimensions the preparation of estimation become very difficult. So, it is very essential before preparing an estimate.

### 1.3.4 SPECIFICATIONS

General Specifications: This gives the nature, quality, class and work and materials in general terms to be used in various parts of work. It helps to form a general idea of building.

Detailed Specifications: These give the detailed description of the various items of work laying down the Quantities and qualities of materials, their proportions, the method of preparation workmanship and execution of work.

### 1.3.5 RATES

For preparing the estimate the unit rates of each item of work are required.

1. for arriving at the unit rates of each item.
2. The rates of various materials to be used in the construction.
3. The cost of transport materials.
4. The wages of labor, skilled or unskilled of masons, carpenters, Amador, etc.,

### 1.3.6 COMPLETE ESTIMATE

Most of people think that the estimate of a structure includes cost of land, cost of materials and labor but many other direct and indirect costs included and are shown below.

L.S. Items.

The following are some of L.S. Items in the estimate.

1. Water supply and sanitary arrangements.
2. Electrical installations like meter, motor, etc.,
3. Architectural features.
4. Contingencies and unforeseen items.

In general, certain percentage on the cost of estimation is allotted for the above L.S. Items. Even if sub estimates prepared or at the end of execution of work, the actual cost should not exceed the L.S. amounts provided in the main estimate.

### **1.3.8 WORK CHARGED ESTABLISHMENT:**

During the construction of a project considerable number of skilled supervisors, work assistance, watch men etc., are employed on temporary basis. The salaries of these persons are drawn from the L.S. amount allotted towards the work charged establishment. That is, establishment which is charged directly to work. An L.S. amount of 1½ to 2% of the estimated cost is provided towards the work charged establishment.

## **1.4 METHODS OF TAKING OUT QUANTITIES**

The quantities like earth work, foundation concrete, brickwork in plinth and super structure etc., can be worked out by any of the following two methods:

- a) Long wall - short wall method
- b) Centre line method.
- c) Partly centre line and short wall method.

### **1.4.1 LONG WALL-SHORT WALL METHOD**

In this method, the wall along the length of room is considered to be long wall while the wall perpendicular to long wall is said to be short wall. To get the length of long wall or short wall, calculate first the centre line lengths of individual walls. Then the length of long wall, (out to out) may be calculated after adding half breadth at each end to its centre line length. Thus the length of short wall

Measured into in and may be found by deducting half breadth from its centre line length at each end. The length of long wall usually decreases from earth work to brick work in super structure while the short wall increases. These lengths are multiplied by breadth and depth to get quantities.

### **1.4.2 CENTRE LINE METHOD**

This method is suitable for walls of similar cross sections. Here the total centre line length is multiplied by breadth and depth of respective item to get the total quantity at a time.

When cross walls or partitions or verandah walls join with main wall, the centre line length gets reduced by half of breadth for each junction. Such junction or joints are studied carefully while calculating total centreline length. The estimates prepared by this method are most accurate and quick.

#### 1.4.4 DETAILED ESTIMATE

The preparation of detailed estimate consists of working out quantities of various items of work and then determines the cost of each item. This is prepared in two stages.

##### D) DETAILS OF MEASUREMENTS AND CALCULATION OF QUANTITIES

The complete work is divided into various items of work such as earth work concreting, brick work, R.C.C. Plastering etc., The details of measurements are taken from drawings and entered in respective columns of prescribed preformed. The quantities are calculated by multiplying the values that are in numbers column to Depth column as shown below:

##### Details of measurements form

S.No	Description of Item	No	Length (L) m	Breadth (B) m	Depth/Height (D/H)m	Quantity	Explanatory Notes

ii)

##### Abstract of Estimated Cost:

The cost of each item of work is worked out from the quantities that already computed in the details measurement form at workable rate. But the total cost is worked out in the prescribed form is known as



#### **1.4.2 Plinth area estimate**

The cost of construction is determined by multiplying plinth area with plinth area rate. The area is obtained by multiplying length and breadth (outer dimensions of building). In fixing the plinth area rate, careful observation and necessary enquiries are made in respect of quality and quantity aspect of materials and labour, type of foundation, height of building, roof, wood work, fixtures, number of storey's etc., As per IS 3861-1966, the following areas

include while calculating the plinth area of building

(1) Earthwork in excavation in foundation, (2) Concrete in foundation, (3) Brickwork in foundation and plinth and (4) Brickwork in superstructure.

The length of long wall centre to centre =  $5.00 + \frac{1}{2} \times .30 + \frac{1}{2} \times .30 = 5.30$  m. The length of short wall centre to centre =  $4.00 + \frac{1}{2} \times .30 + \frac{1}{2} \times .30 = 4.30$  m.

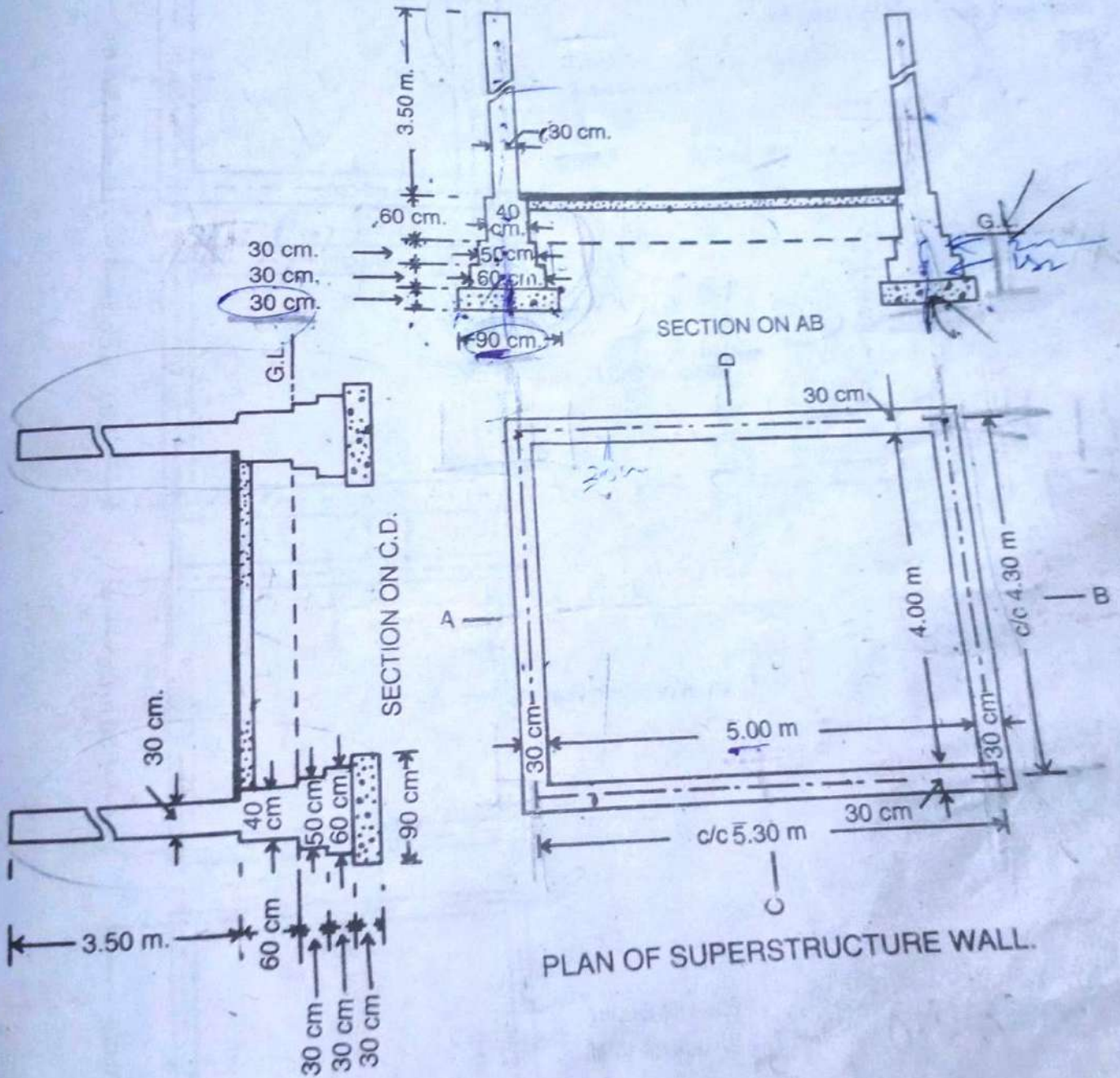

### DETAILS OF MEASUREMENT AND CALCULATION OF QUANTITIES (Ex. 3a)

Item No.	Particulars of Items	No.	Length	Breadth	Height or Depth	Quantity	Explanatory note
1.	<b>Earthwork in excavation in foundation —</b>						
	Long walls ...	2	6.20 m	.90 m	.90 m	10.04	Length = $5.30 + .90 = 6.20$ m Breadth = $4.30 - .90 = 3.40$ m  $4.30 - \frac{0.9}{2} - \frac{0.9}{2}$
	Short walls ...	2	3.40 m	.90 m	.90 m	5.51	
				Total	15.55 cu m		
2.	<b>Concrete in foundation —</b>						
	Long walls ...	2	6.20 m	.90 m	.30 m	3.35	Length same as for excavation Quantity = $\frac{1}{3}$ of excavation
	Short walls ...	2	3.40 m	.90 m	.30 m	1.83	
				Total	5.18 cu m		
3.	<b>Brickwork in foundation and plinth —</b>						
	Long walls —						
	1st footing ...	2	5.90 m	.60 m	.30 m	2.13	Length = $5.30 + .60 = 5.90$ m
	2nd footing ...	2	5.80 m	.50 m	.30 m	1.74	Length = $5.30 + .50 = 5.80$ m
	Plinth walls ...	2	5.70 m	.40 m	.60 m	2.74	Length = $5.30 + .40 = 5.70$ m
	Short walls —						
	1st footing ...	2	3.70 m	.60 m	.30 m	1.33	Length = $4.30 - .60 = 3.70$ m
	2nd footing ...	2	3.80 m	.50 m	.30 m	1.14	Length = $4.30 - .50 = 3.80$ m
Plinth walls ...	2	3.90 m	.40 m	.60 m	1.87	Length = $4.30 - .40 = 3.90$ m	
					Total	10.95 cu m	
4.	<b>Brickwork in superstructure</b>						
	Long walls ...	2	5.60 m	.30 m	3.50 m	11.76	Length = $5.30 + .30 = 5.60$ m
	Short walls ...	2	4.00 m	.30 m	3.50 m	8.40	Length = $4.30 - .30 = 4.00$ m
					Total	20.16 cu m	

**Example 4(a).** — Estimate the quantities of the following items of a two roomed building from the given plan and section (Fig. 2-6) :—

- (1) Earthwork in excavation in foundation,
- (2) Lime concrete in foundation,
- (3) 1st class brickwork in cement mortar 1 : 6 in foundation and plinth,
- (4) 2.5 cm c.c. damp proof course, and
- (5) 1st class brickwork in lime mortar in superstructure.

### TWO ROOMED BUILDING

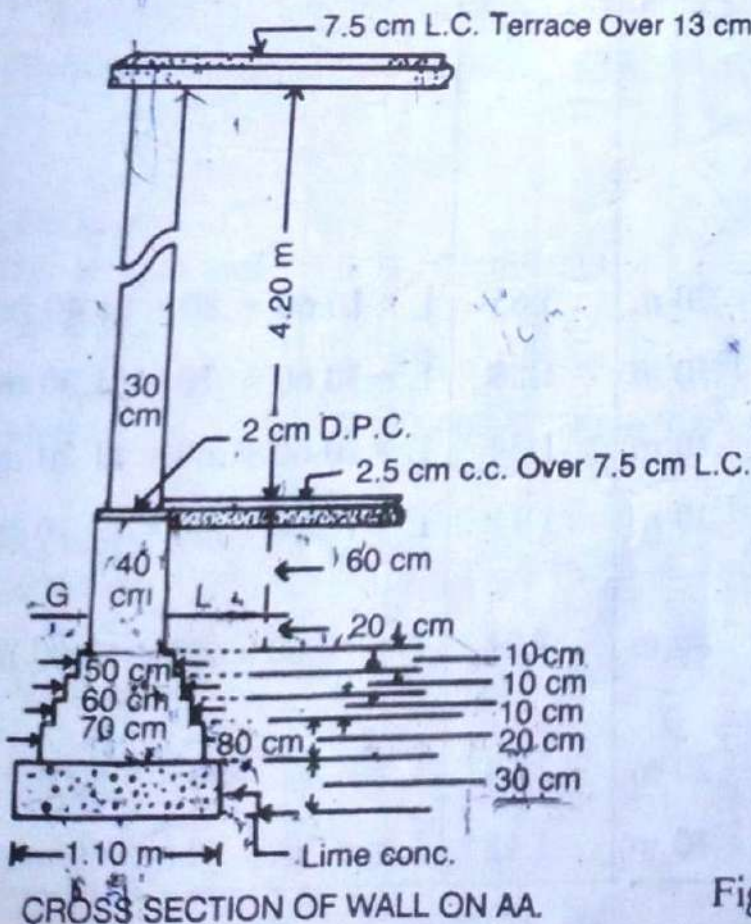
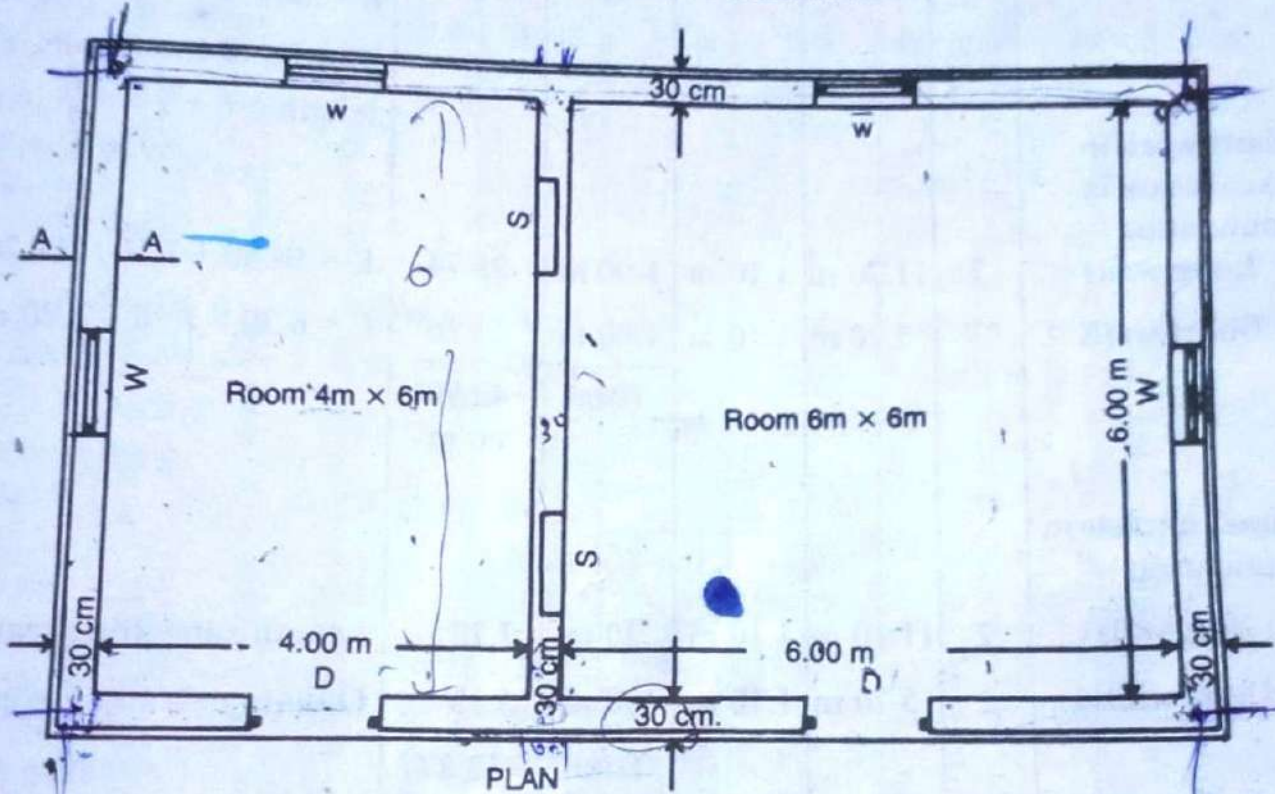

All Walls are of same section  
Lintels over Doors, Windows and  
Shelves are 15 cm thick R.B.

Doors D-1.20 m × 2.10 m  
Windows W-1.00 × 1.50 m  
Shelves S-1.00 m × 1.50 m

Fig. 2-6

**DETAILS OF MEASUREMENT AND CALCULATION OF QUANTITIES (Ex. 4a)**

Item No.	Particulars of Items	No.	Length	Breadth	Height or Depth	Quantity	Explanatory note
1.	<b>Earthwork in excavation in foundation —</b>						Long wall, c/c. length = $4 + 6 + .30 + 2 \times \frac{.30}{2} = 10.60$ m
	Long walls ...	2	11.70 m	1.10 m	1.00 m	25.74	Short and Inter walls, c/c. length = $6 + 2 \times \frac{.30}{2} = 6.30$ m
	Short walls ...	3	5.20 m	1.10 m	1.00 m	17.16	L = $10.60 + 1.10 = 11.70$ m
					Total	42.90 cu m	L = $6.30 - 1.10 = 5.20$ m
2.	<b>Lime concrete in foundation —</b>						
	Long walls ...	2	11.70 m	1.10 m	.30 m	7.72	Length same for excavation
	Short walls ...	3	5.20 m	1.10 m	.30 m	5.15	Quantity = 3/10 of excavation
				Total	12.87 cu m		
3.	<b>1st class brick-work in 1 : 6 cement mortar in foundation and plinth —</b>						
	Long walls —						
	1st footing ...	2	11.40 m	.80 m	.20 m	3.65	L = $10.60 + .80 = 11.40$ m
	2nd footing ...	2	11.30 m	.70 m	.10 m	1.58	L = $10.60 + .70 = 11.30$ m
	3rd footing ...	2	11.20 m	.60 m	.10 m	1.34	L = $10.60 + .60 = 11.20$ m
	4th footing ...	2	11.10 m	.50 m	.10 m	1.11	L = $10.60 + .50 = 11.10$ m
	Plinth wall above footing	2	11.00 m	.40 m	.80 m	7.04	L = $10.60 + .40 = 11.00$ m
	Short walls —						
1st footing ...	3	5.50 m	.80 m	.20 m	2.64	L = $6.30 - .80 = 5.50$ m	
2nd footing ...	3	5.60 m	.70 m	.10 m	1.18	L = $6.30 - .70 = 5.60$ m	

Item No.	Particulars of Items	No.	Length	Breadth	Height or Depth	Quantity	Explanatory note
4.	3rd footing ...	3	5.70 m	.60 m	.10 m	1.03	$L = 6.30 - .60 = 5.70 \text{ m}$
	4th footing ...	3	5.80 m	.50 m	.10 m	0.87	$L = 6.30 - .50 = 5.80 \text{ m}$
	Plinth wall above footing	3	5.90 m	.40 m	.80 m	5.66	$L = 6.30 - .40 = 5.90 \text{ m}$
					Total	26.10	
						cu m	
	<b>Damp proof course</b> 2.5 cm thick c.c. —						
	Long walls ...	2	11.00 m	.40 m	—	8.80	Lengths same as for plinth wall in item 3.
	Short walls ...	3	5.90 m	.40 m	—	7.08	
					Total	15.88	
	Deduct door sills ...	2	1.20 m	.40 m	—	0.96	
			Net	Total	14.92		
					sq m		
5.	<b>1st class brick-work</b> in lime mortar in superstructure						
	Long walls ...	2	10.90 m	.30 m	4.20 m	27.47	$L = 10.60 + .30 = 10.90 \text{ m}$
	Short walls ...	3	6.00 m	.30 m	4.20 m	22.68	$L = 6.30 - .30 = 6.00 \text{ m}$
					Total	50.15	
						cu m	
	<b>Deduct —</b>						
	Door openings	2	1.20 m	.30 m	2.10 m	1.51	
	Window openings ...	4	1.00 m	.30 m	1.50 m	1.80	
	Shelves ...	2	1.00 m	.20 m	1.50 m	0.60	Back of shelves 10 cm thick wall.
	Lintels over doors ...	2	1.50 m	.30 m	.15 m	0.14	Bearing 15 cm
Lintels over windows ...	4	1.30 m	.30 m	.15 m	0.23	Bearing 15 cm	
Lintels over shelves ...	2	1.30 m	.30 m	.15 m	0.12	Bearing 15 cm	
			Total of deduction		4.40	cu m	
			Net	Total	45.75	cu m	

# ESTIMATING AND COSTING RESIDENTIAL BUILDING

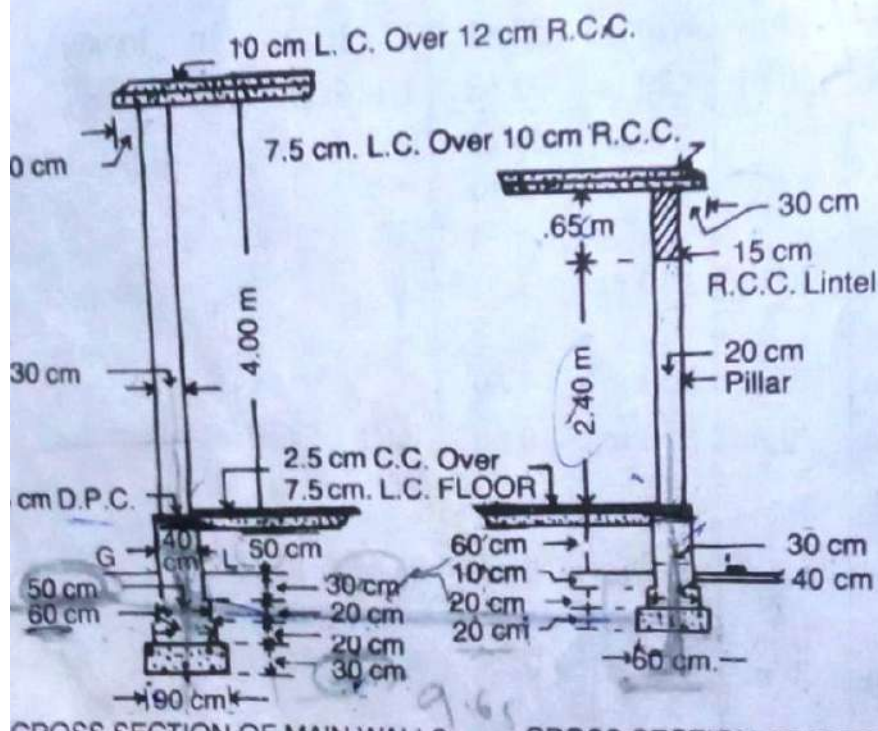
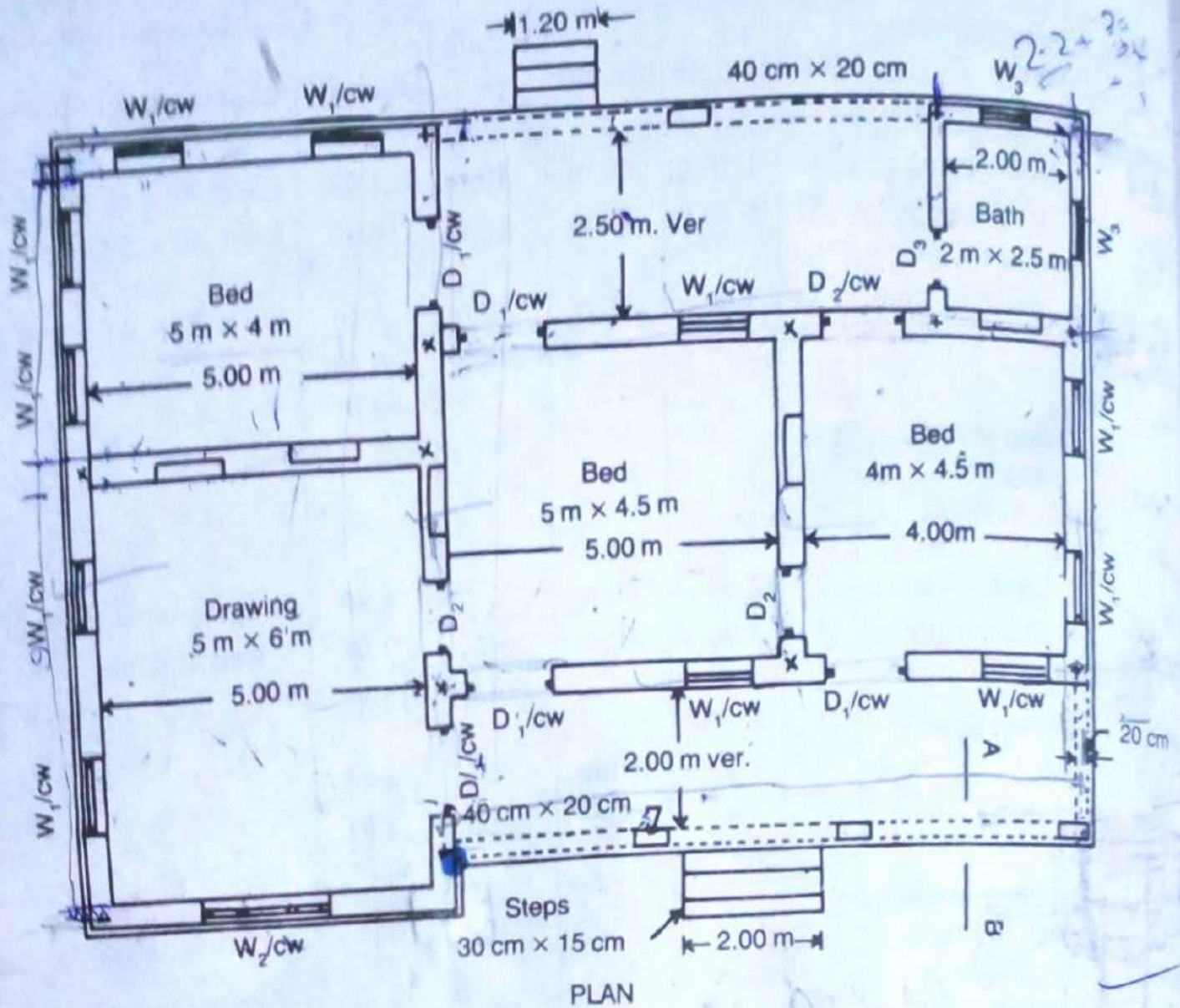

**Doors:-**

- D<sub>1</sub> - 120 cm × 210 cm (1.20 m × 2.10 m)
- D<sub>2</sub> - 100 cm × 200 cm (1.00 m × 2.00 m)
- D<sub>3</sub> - 75 cm × 180 cm (.75 m × 1.80 m)

**Windows:-**

- W<sub>1</sub> - 100 cm × 150 cm (1.00 m × 1.50 m)
- W<sub>2</sub> - 200 cm × 150 cm (2.00 m × 1.50 m)
- W<sub>3</sub> - 75 cm × 120 cm (.75 m × 1.20 m)
- C.W. - 75 cm × 60 cm (.75 m × .60 m)

**Shelves:-**

- S - 100 cm × 150 cm (1.00 m × 1.50 m)
- Lintel Over Doors, Windows Etc.
- 15 cm R.B.

**DETAILS OF MEASUREMENT AND**

Item No.	Particulars of Items	No.	Length	Breadth	Height or Depth	Quantity	Explanatory note	
1.	Earthwork in excavation in foundation — Drawing room and left bed room — Long walls ...	2	11.50 m	.90 m	1.00 m	20.70	$L = 10.60 + .90 = 11.50 \text{ m}$	
	Short walls ...	3	4.40 m	.90 m	1.00 m	11.88	$L = 5.30 - .90 = 4.40 \text{ m}$	
	Bed rooms right side (both) — Long walls ...	2	9.60 m	.90 m	1.00 m	17.28	$L = 9.60 - \frac{.90}{2} + \frac{.90}{2} = 9.60 \text{ m}$	
	Short walls ...	2	3.90 m	.90 m	1.00 m	7.02	$L = 4.80 - .90 = 3.90 \text{ m}$	
	Front verandah Front long wall ...	1	9.50 m	.60 m	.50 m	2.85	$L = 9.65 - \frac{.90}{2} + \frac{.60}{2} = 9.50 \text{ m}$	
	Side short wall ...	1	1.50 m	.60 m	.50 m	0.45	$L = 2.25 - \frac{.90}{2} - \frac{.60}{2} = 1.50 \text{ m}$	
	Back verandah including bath room — Long wall (rear wall including bath) ...	1	9.50 m	.60 m	.50 m	2.85	$L = 9.65 - \frac{.90}{2} + \frac{.60}{2} = 9.50 \text{ m}$	
	Short walls (remaining walls of bath) ...	2	2.00 m	.60 m	.50 m	1.20	$L = 2.75 - \frac{.90}{2} - \frac{.60}{2} = 2.00 \text{ m}$	
	Total					64.23 cu m		
	2.	Lime concrete in foundation — Drawing and left bed room — Long walls ...	2	11.50 m	.90 m	.30 m	6.21	L same as for earthwork in excavation
		Short walls ...	3	4.40 m	.90 m	.30 m	3.56	"
		Bed room right side (both) — Long walls ...	2	9.60 m	.90 m	.30 m	5.18	L same as for earthwork in excavation.
Short walls ...		2	3.90 m	.90 m	.30 m	2.11	" "	
Front verandah Front long wall ...		1	9.70 m	.60 m	.20 m	1.16	$L = 9.65 - \frac{.50}{2} + \frac{.60}{2} = 9.70 \text{ m}$	
Side short wall ...	1	1.70 m	.60 m	.20 m	0.20	$L = 2.25 - \frac{.50}{2} - \frac{.60}{2} = 1.70 \text{ m}$		



(Ex. 5a Contd.)

Item No.	Particulars of Items	No.	Length	Breadth	Height or Depth	Quantity	Explanatory note
3.	Back verandah, including bath room						
	Long wall including bath	1	9.70 m	.60 m	.20 m	1.16	$L = 9.65 - \frac{.50}{2} + \frac{.60}{2} = 9.70m$
	Short wall (remaining walls of bath)	2	2.20 m	.60 m	.20 m	0.53	$L = 2.75 - \frac{.50}{2} - \frac{.60}{2} = 2.70m$
					Total	20.11	cu m
	1st class brickwork in foundation and plinth in 1 : 6 cement mortar Drawing and left bed room Long walls —						
	1st footing	2	11.20 m	.60 m	.20 m	2.69	$L = 10.60 + .60 = 11.20 m$
	2nd footing	2	11.10 m	.50 m	.20 m	2.22	$L = 11.20 - 2 \times .05 = 11.10m$
	Plinth wall above footing	2	11.00 m	.40 m	.90 m	7.92	$L = 11.10 - .10 = 11.00 m$
	Short walls —						
	1st footing	3	4.70 m	.60 m	.20 m	1.69	$L = 5.30 - .60 = 4.70 m$
2nd footing	3	4.80 m	.50 m	.20 m	1.44	$L = 4.70 + 2 \times .05 = 4.80 m$	
Plinth wall above footing	3	4.90 m	.40 m	.90 m	5.29	$L = 4.80 + .10 = 4.90 m$	
Bed rooms right side (both) —							
Long walls —							
1st footing	2	9.60 m	.60 m	.20 m	2.31	$L = 9.60 - \frac{.60}{2} + \frac{.60}{2} = 9.60m$	
2nd footing	2	9.60 m	.50 m	.20 m	1.92	$L = 9.60 - \frac{.50}{2} + \frac{.50}{2} = 9.60m$	
Plinth wall above footing	2	9.60 m	.40 m	.90 m	6.91	$L = 9.60 - \frac{.40}{2} + \frac{.40}{2} = 9.60m$	

Item No.	Particulars of Items	No.	Length	Breadth	Height or Depth	Quantity	Explanatory note
	Short walls —					1.01	$L = 4.80 - .60 = 4.20 \text{ m}$
	1st footing ...	2	4.20 m	.60 m	.20 m	0.86	$L = 4.20 + 2 \times .05 = 4.30 \text{ m}$
	2nd footing ...	2	4.30 m	.50 m	.20 m		
	Plinth wall above footing ...	2	4.40 m	.40 m	.90 m	3.17	$L = 4.30 + 10 = 4.40 \text{ m}$
	Front verandah						
	Front wall —						
	Footing ...	1	9.65 m	.40	.20 m	0.77	$L = 9.65 - \frac{.40}{2} + \frac{.40}{2} = 9.65 \text{ m}$
	Plinth wall above footing ...	1	9.60 m	.30 m	.70 m	2.02	$L = 9.65 - \frac{.40}{2} + \frac{.30}{2} = 9.60 \text{ m}$
	Side short wall						
	Footing ...	1	1.85 m	.40 m	.20 m	0.15	$L = 2.25 - \frac{.40}{2} - \frac{.40}{2} = 1.85 \text{ m}$
	Plinth wall above footing ...	1	1.90 m	.30 m	.70 m	0.40	$L = 2.25 - \frac{.40}{2} - \frac{.30}{2} = 1.90 \text{ m}$
	Back verandah including bath room —						
	Long wall —						
	Footing ...	1	9.65 m	.40 m	.20 m	0.77	} Length same as for front verandah long wall
	Plinth wall above footing ...	1	9.60 m	.30 m	.70 m	2.02	
	Short walls (remaining walls of bath)						
	Footing ...	2	2.35 m	.40 m	.20 m	0.38	$L = 2.75 - \frac{.40}{2} - \frac{.40}{2} = 2.3$
	Plinth wall above footing ...	2	2.40 m	.30 m	.70 m	1.01	$L = 2.75 - \frac{.40}{2} - \frac{.30}{2} = 2.4$
						Total	44.95 cu m

Item No.	Particulars of Items	No.	Length	Breadth	Height or Depth	Quantity	Explanatory note
4.	<b>2.5 cm Damp proof course</b>						
	Drawing and left bed rooms —						
	Long walls ...	2	11.00 m	.40 m	—	8.80	L same as plinth wall.
	Short walls ...	3	4.90 m	.40 m	—	5.88	L same as plinth wall.
	Bed rooms inner side —						
	Long walls ...	2	9.60 m	.40 m	—	7.68	L same as plinth wall.
	Short walls ...	2	4.40 m	.40 m	—	3.52	L same as plinth wall.
	Verandah Pillars ...	4	0.50 m	.30 m	—	0.60	5 cm extra on all sides.
	Bath room —						
	Rear wall ...	1	2.50 m	.30 m	—	0.75	$L = 2.20 + 2 \times .15 = 2.50 \text{ m}$
	Side and inter walls ...	2	2.40 m	.30 m	—	1.44	
					Total	28.67	sq m
	<b>Deduct —</b>						
	Door sills D <sub>1</sub> ...	6	1.20 m	.40 m	—	2.88	
	Door sills D <sub>2</sub> ...	2	1.00 m	.40 m	—	0.80	
	Door sills D <sub>3</sub> ...	1	0.75 m	.30 m	—	0.23	
			Total of deduction			3.91	sq m
			Net	Total		24.76	sq m
5.	<b>1st class brick-work in superstructure in lime mortar—Drawing and left bed room —</b>						
	Long walls ...	2	10.90 m	.30 m	4.00 m	26.16	$L = 10.60 + .30 = 10.90 \text{ m}$
	Short walls ...	3	5.00 m	.30 m	4.00 m	18.00	$L = 5.30 - .30 = 5.00 \text{ m}$

Item No.	Particulars of Items	No.	Length	Breadth	Height or Depth	Quantity	Explanatory note
	Bed room right side —						
	Long walls ...	2	9.60 m	.30 m	4.00 m	23.04	$L = 9.60 - \frac{.30}{2} + \frac{.30}{2} = 9.60$
	Short walls ...	2	4.50 m	.30	4.00 m	10.80	$L = 4.80 - .30 = 4.50$ m
	Front verandah						
	Front wall as solid ...	1	9.60 m	.20 m	3.05 m	5.86	$L = 9.65 - \frac{.30}{2} + \frac{.20}{2} = 9.60$
	Side wall as solid ...	1	2.00 m	.20 m	3.05 m	1.22	
	Back verandah including bath room —						
	Back long wall as solid ...	1	9.60 m	.20 m	3.05 m	5.86	L same as front verandah.
	Side and inter walls of bath ...	2	2.50 m	.20 m	3.05 m	3.05	
					Total	93.99	
						cu m	
	<b>Deduct —</b>						
	Door openings	5					
	D. openings D <sub>1</sub> ...	6	1.20 m	.30 m	2.10 m	4.54	
	D. openings D <sub>2</sub> ...	2	1.00 m	.30 m	2.00 m	1.20	
	D. openings D <sub>3</sub> ...	1	0.75 m	.20 m	1.80 m	0.27	
	Window openings						
	W. openings W <sub>1</sub> ...	11	1.00 m	.30 m	1.50 m	4.95	
	W. openings W <sub>2</sub> ...	1	2.00 m	.30 m	1.50 m	0.90	
	W. openings W <sub>3</sub> ...	2	0.75 m	.20 m	1.20 m	0.36	
	Clerestory window (C.W.) opening ...	18	0.75 m	.30 m	0.60 m	2.43	
	Shelves opening ...	5	1.00 m	.20 m	1.50 m	1.50	Back of shelves 10 cm thick wall.
	Front verandah opening in between pillars ...	1	8.40 m	.20 m	2.40 m	4.03	$L = 9.60 - 3 \times .40 = 8.40$ m
	Front verandah opening side ...	1	2.00 m	.20 m	2.40 m	0.96	
	Back verandah opening ...	1	6.80 m	.20 m	2.40 m	3.26	$L = 9.60 - 2.40 - .40 = 6.80$ m

Item No.	Details of Items	No.	Length	Breadth	Height or Depth	Quantity	Explanatory note
	Lintels →						
	Over doors						
	D. doors D <sub>1</sub> ...	6	1.50 m	.30 m	.15 m	0.405	Bearing 15 cm
	D. doors D <sub>2</sub>	2	1.30 m	.30 m	.15 m	0.117	Bearing 15 cm
	D. doors D <sub>3</sub>	1	.95 m	.20 m	.15 m	0.029	Bearing 10 cm
	Over windows						
	W. windows W <sub>1</sub> ...	11	1.30 m	.30 m	.15 m	0.644	Bearing 15 cm
	W. windows W <sub>2</sub> ...	1	2.30 m	.30 m	.15 m	0.103	Bearing 15 cm
	O. windows W <sub>3</sub> ...	2	.95 m	.20 m	.15 m	0.057	Bearing 10 cm
	Over C.W.	18	.95 m	.30 m	.15 m	0.770	Bearing 10 cm
	Over shelves	5	1.30 m	.30 m	.15 m	0.293	Bearing 15 cm
	Verandah lintels						
	Front ...	1	9.75 m	.20 m	.15 m	0.293	$L = 9.60 + .15 = 9.75 \text{ m}$
	Side ...	1	2.15 m	.20 m	.15 m	0.065	$L = 2.00 + .15 = 2.15 \text{ m}$
	Back ...	1	7.50 m	.20 m	.15 m	0.225	$L = 9.60 - 2.40 + 2 \times .15 = 7.50 \text{ m}$
			Total of deduction			27.401	cu m
			Net	Total		66.59	cu m

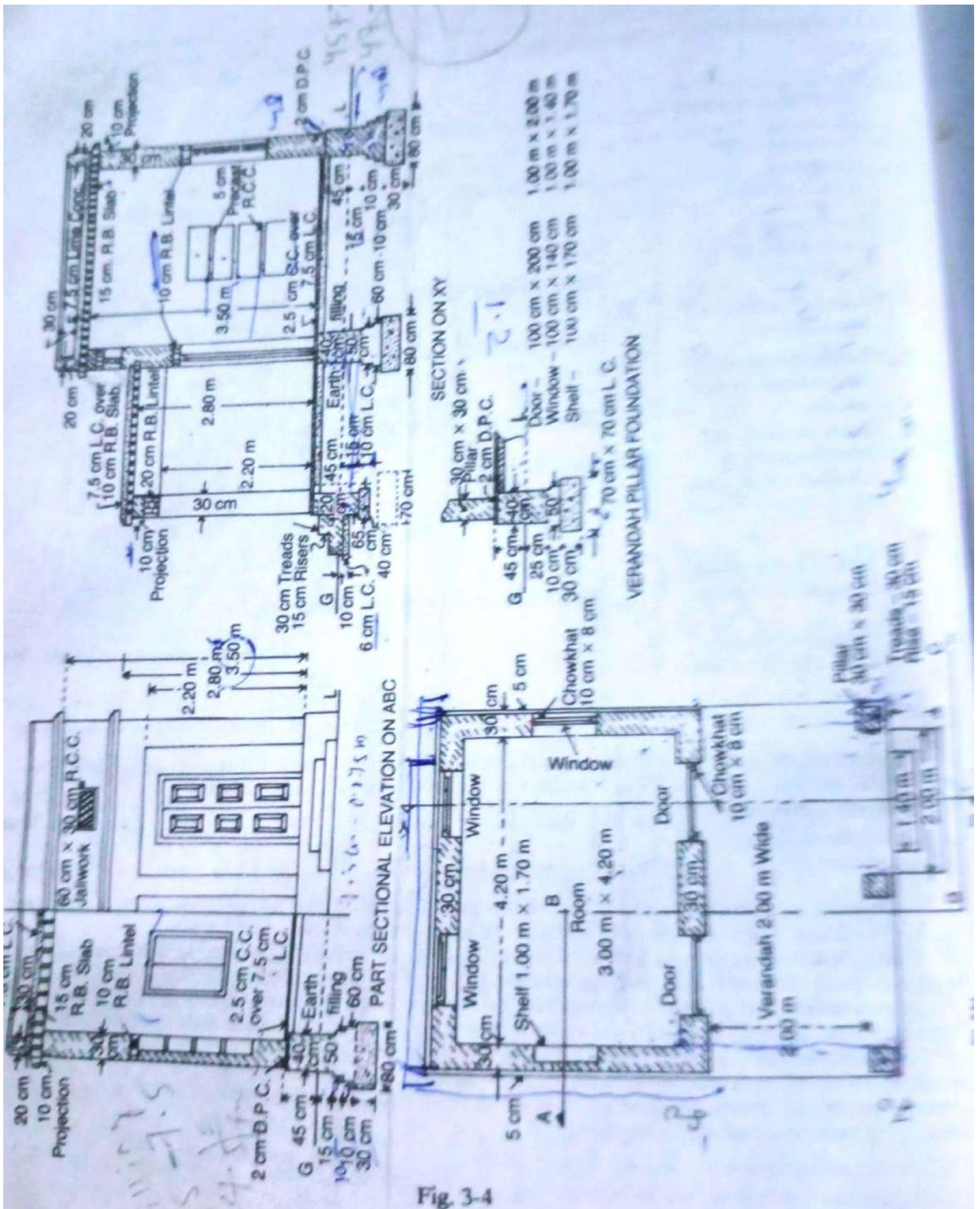

Fig 3-4

Solution

Centre to centre length of walls —  
 Long wall c. to c. length =  $4.20 + .30 = 4.50$  m  
 Short wall c. to c. length =  $3.00 + .30 = 3.30$  m  
 Verandah front c. to c. length =  $4.20 + .30 = 4.50$  m  
 Verandah side c. to c. length =  $2.00 + .30 = 2.30$  m

**DETAILS OF MEASUREMENT AND CALCULATION OF QUANTITIES  
 (SINGLE ROOM BUILDING EX. 4)**

Item No.	Particulars and details of work	No.	Dimensions			Quantity or Content	Explanatory notes
			Length m	Breadth m	Height or Depth m		
1.	<b>Earthwork in excavation in foundation—Room</b>						
	Long walls ...	2	5.30	.80	.65	5.51	$L = 4.50 + .80 = 5.30$ m
	Short walls ...	2	2.50	.80	.65	2.60	$L = 3.30 - .80 = 2.50$ m
	<b>Verandah —</b>						
	Pillars ...	3	.70	.70	.65	0.96	
	Plinth dwarf wall front (sum total length) ...	1	3.10	.40	.25	0.31	$L = 4.50 - 2 \times .70 = 3.10$ m
	Plinth dwarf wall sides ...	2	1.55	.40	.25	0.31	$L = 2.30 - \frac{.80}{2} - \frac{.70}{2} = 1.55$ m
	Step ...	1	2.10	.65	.10	0.14	
					Total	9.83 cu m	
2.	<b>Earthwork in filling in Plinth—</b>						
	Room ...	1	4.10	2.90	.375	4.46	$L = 4.90 - .40 = 4.50$ m
	Verandah ...	1	4.50	2.10	.375	3.54	$B = 2.35 - .20 - .05 = 2.10$ m
					Total	8.00	
	<b>Deduct —</b>						
	Projection central pillar ...	1	.40	.20	.375	0.03	These deductions may be neglected being small.
	Projection side pillar ...	2	.20	.20	.375	0.03	
					Total	0.06	
			Net	Total		7.94 cu m	

Item No.	Particulars of Items and details of work	No.	Dimensions			Quantity or Content	Explanatory notes
			Length m	Breadth m	Height or Depth m		
3.	<b>Lime concrete in foundation—</b> Room —						
	Long walls ...	2	5.30	.80	.30	2.54	
	Short walls ...	2	2.50	.80	.30	1.20	
	Verandah Pillars ...	3	.70	.70	.30	0.44	
	Dwarf wall front (sum total length) ...	1	3.70	.40	.10	0.15	$L=4.50 - 2 \times .40 = 3.70 \text{ m}$
	Dwarf wall sides ...	2	1.85	.40	.10	0.15	$L=2.30 - \frac{.50}{2} - \frac{.40}{2} = 1.85$
	Step ...	1	2.10	.65	.06	0.08	
					Total	4.56 cu m	
4.	<b>First class Brickwork in Foundation and Plinth in lime mortar—</b> Room—						
	Long walls —						
	1st footing ...	2	5.10	.60	.10	0.61	$L = 4.50 + .60 = 5.10 \text{ m}$
	2nd footing ...	2	5.00	.50	.10	0.50	$L = 4.50 + .50 = 5.00 \text{ m}$
	Plinth wall above footing ...	2	4.90	.40	.60	2.35	$L = 4.50 + .40 = 4.90 \text{ m}$
	Short walls —						
	1st footing ...	2	2.70	.60	.10	0.32	$L = 3.30 - .60 = 2.70 \text{ m}$
	2nd footing ...	2	2.80	.50	.10	0.28	$L = 3.30 - .50 = 2.80 \text{ m}$
	Plinth wall ...	2	2.90	.40	.60	1.39	$L = 3.30 - .40 = 2.90 \text{ m}$
	Verandah —						
	Pillars footing ...	3	.50	.50	.10	0.075	
	Pillars Plinth ...	3	.40	.40	.70	0.336	
	Dwarf wall front (sum total length) ...	1	3.70	.20	.60	0.44	$L=4.50 - 2 \times .40 = 3.70 \text{ m}$
	Dwarf wall sides ...	2	1.90	.20	.60	0.46	$L = 2.30 - .40 = 1.90 \text{ m}$
					C.O.	6.76	



Particulars of Items and details of work	No.	Dimensions			Quantity or Content	Explanatory notes
		Length m	Breadth m	Height or Depth m		
Step —				B.F.		
1st step ...	1	2.00			6.76	
2nd step ...	1	1.40	.60	.19	0.23	
			.30	.15	0.06	
				Total	7.05 cu m	
<b>2 cm D. P. C. of 1:2 cement mortar with water-proofing materials—</b>						
Long walls ...	2	4.90	.40	—	3.92	Length, breadth same plinth wall.
Short walls ...	2	2.90	.40	—	2.32	
Verandah —						
Pillars ...	3	.40	.40	—	0.48	
Deduct door sills ...	2	1.00	.40	—	6.72 0.80	
				Total	5.92 sq m	
<b>1-class Brickwork in superstructure in lime mortar—</b>						
Room—						
Long walls ...	2	4.80	.30	3.50	10.08	L = 4.50 + .30 = 4.80 m L = 3.30 - .30 = 3.00 m
Short walls ...	2	3.00	.30	3.50	6.30	
Verandah —						
Pillars ...	3	.30	.30	2.20	0.59	
Front above lintel ...	1	4.80	.30	.40	0.57	
Sides above lintel ...	2	2.00	.30	.40	0.48	
Parapet long walls ...	2	4.80	.20	.375	0.72	
Parapet short walls ...	2	3.20	.20	.375	0.48	
				Total	19.22	
<b>Deduct —</b>						
Door openings ...	2	1.00	.30	2.00	1.20	
Window openings ...	3	1.00	.30	1.40	1.26	
Shelf ...	1	1.00	.20	1.70	0.34	
Ventilators ...	2	.60	.30	.30	0.11	

Item No.	Particulars of Items and details of work	No.	Dimensions			Quantity or Content	Explanatory notes
			Length m	Breadth m	Height or Depth m		
7.	Lintel over doors ...	2	1.20	.30	.10	0.07 (a)	10 cm bearing.  Total of (a) s = 0.24 cu m
	Lintel over windows ...	3	1.20	.30	.10	0.11 (a)	
	Lintel over shelves ..	1	1.20	.30	.10	0.04 (a)	
	Lintel over ventilator ...	1	.80	.30	.10	0.02 (a)	
	Total			of deduction		3.15	
				Net	Total	16.07 cu m	
	Roof of room ...	1	5.00	3.80	.15	2.850	15 cm bearing.  Out to out.  15 cm bearing
	Roof of verandah ...	1	5.00	2.55	.10	1.275	
	Lintel verandah front ...	1	4.80	.30	.20	0.288	
	Lintel verandah sides ...	2	2.15	.30	.20	0.258	
Lintel over doors, windows, etc ...	Same marked	as for (a) in	items	item 6	0.240		
			Total		4.911 cu m		
8.	7.5 cm Lime concrete in roof terracing complete with surface finishing—						
	Roof of room ...	1	4.40	3.20	—	14.08	
	Roof of verandah	1	5.00	2.40	—	12.00	
			Total		26.08 cu m		
9.	Sal wood work in chowkhat —						
	Doors (including 4 cm insertion into floor) ...	2	5.08	.10	.08	0.081	{ 2 Vert. — 2.04 m each 1 Hor. — 1.00 m each { 2 Vert. — 1.40 m each 2 Hor. — 1.00 m each
	Windows ...	3	4.80	.10	.08	0.115	
				Total		0.196 cu m	
			Total		0.196 cu m		

Sl. No.	Particulars of the items and nature of work	No.	Dimensions			Quantity or Content	Explanatory notes
			Length m	Breadth m	Height or Depth m		
11.	15 cm thick finished surfaces of Door work	2	0.87	1.935	—	3.367	15 cm rebate.
		3	0.87	0.27	—	3.315	
		Total				6.682 sq m	
12.	Door fittings including lock and fitting for doors and windows	Same as for item (10)				6.68 sq m	
13.	Finish R.C.C. slab above complete work including steel reinforcement and form work	3	1.08	0.20	0.05	0.032 cu m	4 cm bearing.
14.	R.C.C. slab work 4 cm thick in ventilators complete work including steel reinforcement and form work	2	.60	.30	—	0.36 sqm	
15.	Mild steel in Reinforcement bars including bending in R.C.C. work (at 0.7% of area)		$\frac{4.91 \times 7}{100}$	x	78.5 =	2.698 q	Density of mild steel = 78.5 q/cu m
	Hold fasts in doors and windows	24 @ 1 kg each =			24 kg =	.24 q	6 nos. in each door and 4 nos. in each window. (Hold fasts may be taken under separate item).
	Total					2.938 q	
16.	2.5 cm c.c. 12x floor over and including 2.5 cm lime concrete	1	4.20	3.00	—	12.60	$\left\{ \begin{aligned} L &= \text{Out to out} - 2 \text{ dw} \\ &\text{walls,} \\ &= (4.2 + 2 \times .30 + 2 \times .05) \\ &\quad - 2 \times .20 = 4.50 \text{ m} \\ B &= (2.0 + .30 + .05) - .20 \\ &= 2.15 \text{ m} \end{aligned} \right.$
		1	4.50	2.15	—	9.68	
		Total				22.28	

Item No.	Particulars of Items and details of work	No.	Dimensions			Quantity or Content	Explanatory notes
			Length m	Breadth m	Height or Depth m		
6.	<b>Deduct—Central pillars</b>	1	.30	.15	—	0.045	L = 4.80 - 3 × .30 = 3.90 m
	<b>Side pillars ...</b>	2	.15	.15	—	0.045	
					<b>Total</b>	0.090	
				<b>Net</b>	<b>Total</b>	22.19 sq m	
	<b>2.5 cm c. c. 1:2:4: floor (without lime concrete)—</b>						
	Doors sills ...	2	1.00	.30	—	0.60	
	Sills of verandah opening—Front in between pillars...	1	3.90	.20	—	0.78	
	Sides ...	2	2.00	.20	—	0.80	
					<b>Total</b>	2.18 sq m	
	<b>12 mm Plastering in ceiling with 1:3 cement and coarse sand mortar—</b>						
Room ...	1	4.20	3.00	—	12.60		
Verandah ...	1	4.20	2.00	—	8.40		
				<b>Total</b>	21.00 sq m		
<b>12 mm Plastering in walls with 1:1:6 cement lime and local sand mortar</b>							
<b>Inside—</b>							
<b>Room—</b>							
Long walls ...	2	4.20	—	3.50	29.40		
Short walls ...	2	3.00	—	3.50	21.00		
Jambs, sill and soffit of shelf	1	5.40	.20	—	1.08	L = 1.00 × 2 + 1.70 ×	
<b>Verandah—</b>							
Wall ...	1	4.20	—	2.80	11.76		
Pillar inner face	7	.30	—	2.20	4.62	3 faces of central pillar and 2 faces of each pillar.	
				<b>C.O.</b>	67.86		

Item No.	Particulars of Items and details of work	No.	Dimensions			Quantity or Content	Explanatory notes
			Length m	Breadth m	Height or Depth m		
	Verandah above pillars (inner face) front	1			B.F.	67.86	
	—Do— Sides	2	4.20	—	.60	2.52	
	Soffits of verandah lintels front	1	2.00	—	.60	2.40	
	Soffits of verandah lintel sides	1	3.90	.30	—	1.17	$L = 4.80 - 3 \times .30 = 3.90 \text{ m}$
	Vertical faces of inner wall below lintel	2	2.00	.30	—	1.20	
		2	—	.30	2.20	1.32	
				Total	...	76.47	
	Deduct door openings	2	1.00	—	2.00	4.00	One surface to each.
				Net	Total	72.47 sq m	Total of inside plastering.
	<b>Outside—</b>						
	Room —						
	Back wall	1	4.80	—	3.50	16.80	
	Side walls	2	3.60	—	3.50	25.20	
	Plinth including 10 cm below G. L. and 5 cm offset back	1	4.90	—	.60	2.94	Ht. = .45 + .05 + .10 = .60 m
	— Do — Sides	2	3.65	—	.60	4.38	
	Front wall above verandah roof	1	4.80	—	.525	2.52	Ht. = 3.50 - 2.975 = .525 m
	Roof projections front and back	2	5.00	—	.25	2.50	Ht. = .15 + .10 = .25 m
	—Do— Sides	2	3.60	—	.25	1.80	
	Verandah pillar outer faces	5	0.30	—	2.20	3.30	One face of central p and two faces each c pillars.
					C.O.	59.44	

Item No.	Particulars of Items and details of work	No.	Dimensions			Quantity or Content	Explanatory notes
			Length m	Breadth m	Height or Depth m		
	Verandah above pillars (outer face)				B.F.	59.44	
	front ...	1	4.80	—	.60	2.88	
	—Do— Sides ...	2	2.30	—	.60	2.76	
	Verandah Plinth wall front ...	1	4.90	—	.55	2.70	Step to be deducted.
	—Do— Sides ...	2	2.35	—	.55	2.59	
	Parapet walls (all four walls) ...	1	16.00	—	.875	14.00	{ Total centre length = $2 \times 4.60 + 2 \times 3.40$ = 16.00 m Ht. = $.30 + .20 + .375$ = .875 m
					Total	84.37	
	<b>Deduct—</b>						
	Window openings ...	3	1.00	—	1.40	4.20	One face of each. No deduction.
	Ventilators ...	—	—	—	—	—	
	Step ...	1	2.00	—	.55	1.10	
					Total	5.30	
				Net	Total	79.07 sq m	Total of outside plastering.
19.	<b>20 mm cement plaster 1:3 in steps finished with neat cement —</b>						
	1st step —						
	Tread ...	1	2.60	.30	—	0.78	
	Rise ...	1	3.20	—	.15	0.48	
	2nd step—						
	Tread ...	1	1.40	.30	—	0.42	
	Rise ...	1	2.00	—	.15	0.30	
	Plinth wall ...	1	1.40	—	.15	0.21	
		2	0.30	—	.30	0.18	
					Total	2.37 sq m	
			Grand total and outside	of inside plastering =		72.47 +	79.07 = 151.54 sq m

Item No.	Particulars of Items and details of work	No.	Dimensions			Quantity or Content	Explanatory notes
			Length m	Breadth m	Height or Depth m		
20.	White washing 3 coats— Inside wall ...	Same as inside plaster in item (18)			..	72.47	
	Ceiling ...	Same as ceiling plaster in item (17)			..	21.00	
					Total	93.47 sq m	
21.	Colour washing one coat over two coats of white washing ...	Same as out side (18)			plaster ..	79.07	$\left\{ \begin{array}{l} L = \text{outer perimeter minus step.} \\ = (4.90 \times 2 + 6.00 \times 2) - 2.00 = 19.80 \text{ m} \end{array} \right.$
	Deduct portion below G.L. ...	1	19.80	—	.10	1.98	
					Total	77.09 sq m	
22	Painting of doors and windows two coats over one coat of priming—						
	Doors ...	2 × 2¼	1.00	—	2.00	9.00	1½ for one face.
	Windows ...	3 × 2¼	1.00	—	1.40	9.45	1½ for one face.
				Total	18.45 sq m		

# TWO-ROOM BUILDING WITH FRONT VERANDAH

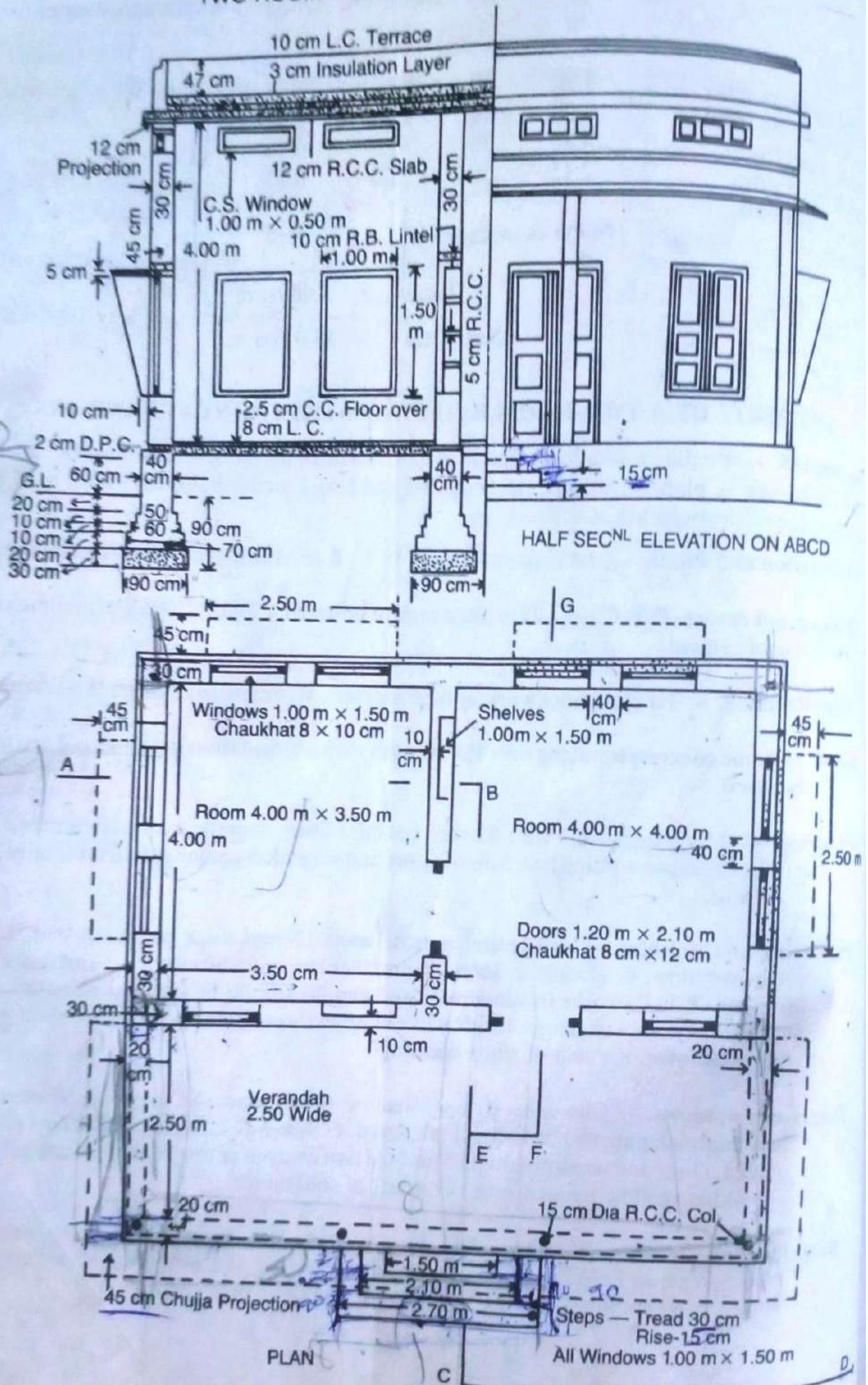

Fig. 3-5



## CROSS-SECTION OF TWO-ROOMED BUILDING

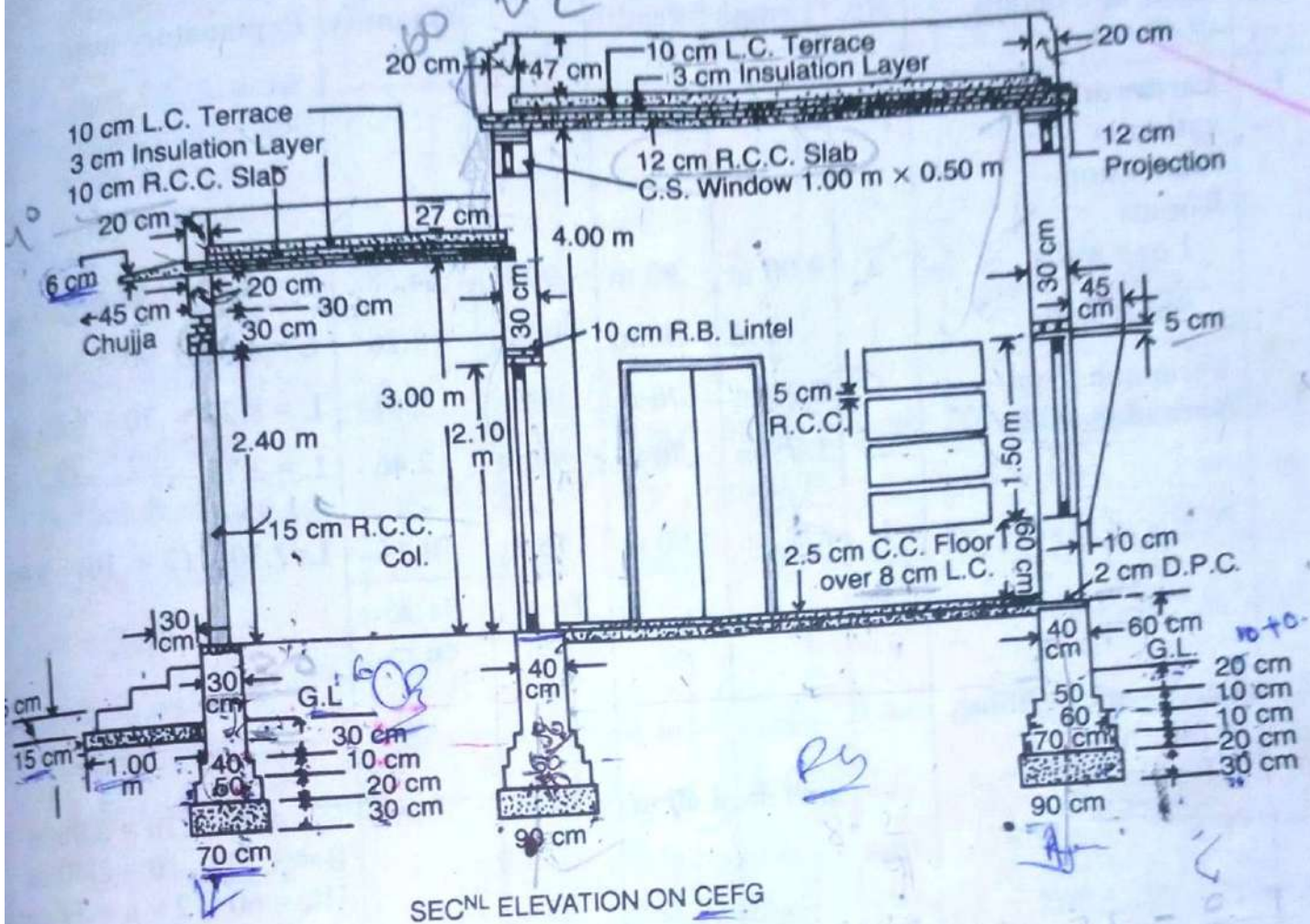

Fig. 3-6

Note — Foundation of verandah is continuous of same section.

Centre to centre lengths —

Room Long walls —  $3.50 + 4.00 + .30 + (2 \times \frac{.30}{2}) = 8.10$  m combined total length.

Room Short walls —  $4.00 + (2 \times \frac{.30}{2}) = 4.30$  m

Verandah Front — Extreme outer length at plinth —  $(2 \times \frac{.30}{2})$   
 $= \{ 3.50 + 4.00 + (3 \times .30) + (2 \times .05) \} - .30 = 8.20$  m

Verandah Sides —  $2.50 + \frac{.30}{2} + \frac{.20}{2} = 2.75$  m

Item No.	Particulars of items and details of works	No.	Length	Breadth	Height or Depth	Quantity	Explanatory note	
1.	<b>Earthwork in excavation in foundation—</b>							
	<b>Rooms</b>							
	Long walls	...	2	9.00 m	.90 m	.90 m	14.58	$L = 8.10 + .90 = 9.00 \text{ m}$
	Short walls	...	3	3.40 m	.90 m	.90 m	8.26	$L = 4.30 - .90 = 3.40 \text{ m}$
	Verandah front	...	1	8.90 m	.70 m	.90 m	5.61	$L = 8.20 + .70 = 8.90 \text{ m}$
	Verandah sides	...	2	1.95 m	.70 m	.90 m	2.46	$L = 2.75 - \frac{.90}{2} - \frac{.70}{2} = 1.95 \text{ m}$
Step	...	1	2.90 m	1.00 m	.15 m	0.44	$L = 2.70 + (2 \times .10) = 2.90 \text{ m}$	
					Total	31.35 cu m		
2.	<b>Earthwork in filling in plinth—</b>							
	<b>Room (i)</b>							
	Room (i)	...	1	3.90 m	3.40 m	.54 m	7.16	$L = 4.00 - .10 = 3.90 \text{ m}$ $B = 3.50 - .10 = 3.40 \text{ m}$ $Ht. = 60 + 2 - 8 = 54 \text{ cm} = .54 \text{ m}$
	Room (ii)	...	1	3.90 m	3.90 m	.54 m	8.22	$L = 8.20 - .30 = 7.90 \text{ m}$ $B = 2.75 - \frac{.40}{2} - \frac{.30}{2} = 2.40 \text{ m}$
	Verandah	...	1	7.90 m	2.40 m	.54 m	10.23	
					Total	25.61 cu m		
3.	<b>Lime concrete in foundation</b>							
	<b>Rooms —</b>							
	Long walls	...	2	9.00 m	.90 m	.30 m	4.86	May be taken 1/3 of excavation.
	Short walls	...	3	3.40 m	.90 m	.30 m	2.75	
	Verandah front	...	1	8.90 m	.70 m	.30 m	1.87	
	Verandah sides	...	2	1.95 m	.70 m	.30 m	0.82	
	Step	...	1	2.90 m	1.00 m	.15 m	0.44	
					Total	10.74 cu m		

Particulars of items and details of works	No.	Length	Breadth	Height or Depth	Quantity	Explanatory note
<b>1st-class Brick-work in Foundation and Plinth in 1 : 6 cement mortar—</b>						
<b>ROOMS —</b>						
<b>Long walls —</b>						
1st footing ...	2	8.80 m	.70 m	.20 m	2.46	$L = 8.10 + .70 = 8.80 \text{ m}$
2nd footing ...	2	8.70 m	.60 m	.10 m	1.04	$L = 8.80 - .10 = 8.70 \text{ m}$
3rd footing ...	2	8.60 m	.50 m	.10 m	0.86	$L = 8.70 - .10 = 8.60 \text{ m}$
Plinth wall ...	2	8.50 m	.40 m	.80 m	5.44	$L = 8.60 - .10 = 8.50 \text{ m}$
<b>Short walls —</b>						
1st footing ...	3	3.60 m	.70 m	.20 m	1.51	$L = 4.30 - .70 = 3.60 \text{ m}$
2nd footing ...	3	3.70 m	.60 m	.10 m	0.67	$L = 3.60 + .10 = 3.70 \text{ m}$
3rd footing ...	3	3.80 m	.50 m	.10 m	0.57	$L = 3.70 + .10 = 3.80 \text{ m}$
Plinth wall ...	3	3.90 m	.40 m	.80 m	3.74	$L = 3.80 + .10 = 3.90 \text{ m}$
<b>VERANDAH—</b>						
<b>Front wall (long)—</b>						
1st footing ...	1	8.70 m	.50 m	.20 m	0.87	$L = 8.20 + .50 = 8.70 \text{ m}$
2nd footing ...	1	8.60 m	.40 m	.10 m	0.34	$L = 8.70 - .10 = 8.60 \text{ m}$
Plinth wall ...	1	8.50 m	.30 m	.90 m	2.30	$L = 8.60 - .10 = 8.50 \text{ m}$
<b>Side wall (short) —</b>						
1st footing ...	2	2.15 m	.50 m	.20 m	0.43	$L = 2.75 - \frac{.50}{2} - \frac{.70}{2} = 2.15 \text{ m}$
2nd footing ...	2	2.25 m	.40 m	.10 m	0.18	$L = 2.75 - \frac{.40}{2} - \frac{.60}{2} = 2.25 \text{ m}$
				C.O.	20.41	

Item No.	Particulars of items and details of works	No.	Length	Breadth	Height or Depth	Quantity	Explanatory note
	Plinth wall 10 cm above footing ...	2	2.35 m	.30 m	B.F. 0.10 m	20.41 0.14	$L=2.75 - \frac{.50}{2} - \frac{.30}{2} =$ $L=2.75 - \frac{.40}{2} - \frac{.30}{2} =$
	Plinth wall remaining portion ...	2	2.40 m	.30 m	.80 m	1.15	
	Steps —						
	1st step ...	1	2.70 m	.90 m	.15 m	0.36	
	2nd step ...	1	2.10 m	.60 m	.15 m	0.19	
	3rd step ...	1	1.50 m	.30 m	.15 m	0.07	
					Total	22.32 cu m	
	<b>2 cm Damp proof course</b>						
	Rooms —						
	Long walls ...	2	8.50 m	.40 m	—	6.80	
	Short walls ...	3	3.90 m	.40 m	—	4.68	
					Total	11.48	
	Deduct door sills ...	2	1.20 m	.40 m	—	0.96	
				Net	Total	10.52 sq m	
	<b>I-class Brick-work in superstructure in lime mortar—</b>						
	Rooms —						
	Long walls ...	2	8.40 m	.30 m	4.00 m	20.16	Length — Out to out.
	Short walls ...	3	4.00 m	.30 m	4.00 m	14.40	Length — In to in.
	Ver. above lintels (over pillars)—						
	Front (long) ...	1	8.40 m	.20 m	.30 m	0.50	
	Sides (short) ...	2	2.50 m	.20 m	.30 m	0.30	
	Parapet —						
	Over Rooms —						
	Long walls ...	2	8.40 m	.20 m	.60 m	2.02	Ht. = 47 + 10 + 3 = 60 cm = .60 m
	Short walls ...	2	4.20 m	.20 m	.60 m	1.01	L = 4.00 + (2 × .30) - (2 × .20) = 4.20 m
					C.O.	38.39	

Item No.	Particulars of items and details of works	No.	Length	Breadth	Height or Depth	Quantity	Explanatory notes
					B.F.	38.39	
	Verandah — Front (long) ...	1	8.40 m	.20 m	.40 m	0.67	Ht. = 27 + 10 +
	Side (short) ...	2	2.50 m	.20 m	.40 m	0.40	
					Total	39.46 cu m	
	<b>Deduct—</b>						
	Door openings ...	2	1.20 m	.30 m	2.10 m	1.51	
	Window openings	10	1.00 m	.30 m	1.50 m	4.50	
	C.S. Window ,, ...	12	1.00 m	.30 m	0.50 m	1.80	
	Shelves ,, ...	2	1.00 m	.20 m	1.50 m	0.60	Back of shelf
	R.B. lintels over— Doors ...	2	1.40 m	.30 m	.10 m	0.084 (a)	10 cm bearing
	Windows ...	10	1.20 m	.30 m	.10 m	0.360 (a)	
	C.S.Windows ...	12	1.20 m	.30 m	.10 m	0.432 (a)	Total of (a)
	Shelves ...	2	1.20 m	.30 m	.10 m	0.072 (a)	+ = 0
					Total	9.36	
				Net	Total	30.10 cu m	
7.	<b>R. B. work in lintels</b> excluding steel and its bending but including centering and shuttering and binding steel— Over doors, windows and shelves ...		Same (a) in	as for item	items no. 6 =	marked 0.48	
	Over ver. pillars— Front ...	1	8.40	.20	.30	0.504	Out
	Sides ...	2	2.80	.20	.30	0.336	Insid
					Total	1.788 cu m	

Item No.	Particulars of items and details of works	No.	Length m	Breadth m	Height or Depth m	Quantity	Explanations
8.	R. C. C. work in ver. columns excluding steel and its bending, but including form work and binding steel complete fair finished	4	$\frac{\pi (.15)^2}{4}$	×	2.70	= 0.19 cu m	30 cm in plinth w
9.	R.C.C. work excluding steel and its bending, but including centering and shuttering and binding steel, fair finished—						
	Roof slab rooms ...	1	<u>8.64</u>	<u>4.84</u>	<u>.12</u>	<del>5.018</del>	12 cm p
	Roof slab ver. ...	1	<u>8.40</u>	<u>2.80</u>	<u>.10</u>	<del>2.352</del>	10 cm i excludi
	Chujja projections						
	Ver. front ...	1	<u>9.30</u>	<u>.45</u>	<u>.06</u>	<del>0.251</del>	Average
	Ver. sides ...	2	<u>2.70</u>	<u>.45</u>	<u>.06</u>	<del>0.146</del>	
	Sun-shed and						

Item No.	Particulars of items and details of works	No.	Length m	Breadth m	Height or Depth m	Quantity	Explanatory notes	
11.	<b>10-cm Lime concrete in roof terracing complete with surface finishing—</b> Rooms ... Verandah ...	1	8.00	4.20	—	33.60	Clear roof area in between parapet. " " "	
		1	8.00	2.50	—	20.00		
		Total						53.60 sq m
12.	<b>3-cm thick insulation layer of sand and clay—</b> Rooms ... Verandah ...	1	8.00	4.20	—	33.60	Clear roof area. " "	
		1	8.00	2.50	—	20.00		
		Total						53.60 sq m
13.	<b>Sal wood work in chowkhat wrought framed and fixed—</b> Doors (3 cm insertion into floor) ... Windows ... C.S. Windows ...	2	$(2.13 + 2.13 + 1.2)$ 5.46		.12	.08	0.105	{ 2 Vert.—2.13 m each. { 1 Hor.—1.20 m each. { 2 Vert.—1.50 m each { 2 Hor.—1.00 m each. { 2 Vert.—0.50 m each. { 2 Hor.—1.00 m each.
		10	5.00	.10	.08	0.400		
		12	3.00	.08	.08	0.230		
		Total					0.735 cu m	
							2 1.2	
14.	<b>4 cm thick Indian teak wood panelled door and window shutters including fittings—</b> Doors ... Windows ...	2	1.07	—	2.035	4.355	Rebate 1.5 cm.	
		10	0.87	—	1.37	11.919		
		Total						16.274 sq m
15.	<b>4 cm thick Indian teak wood glazed shutters including fittings—</b> C.S. Windows ...	12	0.87	—	0.37	3.863 sq m		

17.	12 mm thick plastering in walls 1 : 1 : 6 cement, sand, lime mortar —				4.00	28.00	} May be taken as inner perimeter × ht. = 15.00 × 4.00
	INSIDE —				4.00	32.00	
	Rooms —	2	3.50	—	4.00	64.00	} Length out to out.
	(i) ...	2	4.00	—	4.00		
	(ii) ...	4	4.00	—	3.00	25.20	
	Verandah inner wall	1	8.40	—		4.80	
	Ver. Front above cols. inner face ...	1	8.00	—	.60	4.80	} $L = 2 \times 1.0 + 2 \times 1.5 = 5.0 \text{ m}$
	Ver. Sides above cols. inner face ...	2	2.50	—	.60	3.00	
	Jambs sills and soffits of shelves ...	2	5.00	.20	—	2.00	
	Soffits of ver. lintel —						
	Front ...	1	8.40	.20	—	1.68	} No deduction for col. end
	Sides ...	2	2.50	.20	—	1.00	
					Total	161.68	



Particulars of items and details of works	No.	Length m	Breadth m	Height or Depth m	Quantity	Explanatory notes
Deduct openings in wall in between ver. and room —						
Door openings ...	2	1.20	—	2.10	5.04	One surface of each.
Window openings ...	2	1.00	—	1.50	3.00	One surface of each.
				Total	8.04	Other doors and windows deducted from outside.
			Net	Total	153.64	Total of inside plastering.
					sq m	
<b>OUTSIDE —</b>						
Rooms —						
Back plinth including 10 cm below G.L. ...	1	8.50	—	.75	6.38	Ht. = .60 + .05 + .10 = .75 m These can be combined as — $1 \times 8.40 \times 4.75 = 39.90$
Back super-structure ...	1	8.40	—	4.00	33.60	
Sides plinth including 10 cm below G.L. ...	2	4.70	—	.75	7.05	These can be combined as — $2 \times 4.60 \times 4.75 = 43.70$
Sides super-structure ...	2	4.60	—	4.00	36.80	
Verandah —						
Above cols. front outer face ...	1	8.40	—	.60	5.04	
Above cols. sides outer face ...	2	2.70	—	.60	3.24	
Plinth front including 10 cm below G.L. ...	1	8.50	—	.70	5.95	Ht. = .60 + .10 = .70 m
Plinth sides ...	2	2.75	—	.70	3.85	
Wall above ver. roof Parapet —	1	8.40	—	.77	6.47	Ht. = $4.00 - 3.23 = .77$ m
Rooms —						
Long wall outer face	2	8.40	—	.60	10.08	These can be taken approx. in one operation as — = (total centre length + inner ht. + top width × outer ht.)
Long wall inner face ...	2	8.00	—	.47	7.52	
Long wall top face ...	2	8.40	.20	—	3.36	= $(2 \times 8.40 + 2 \times 4.20) \times (.47 + .20 + (.47 + .10 + .03))$ = $25.20 \times 1.27 = 32.00$ sq m.
Short walls outer face ...	2	4.60	—	.60	5.52	
Short walls inner face ...	2	4.20	—	.47	3.95	
Short walls top face ...	2	4.20	.20	—	1.68	
				C.O.	140.49	

No.	Particulars of items and details of works	No.	Length m	Breadth m	Height or Depth m	Quantity	Explanatory notes
					B.F.	140.49	
	Verandah parapet—				27 + 10 + 3		
	Front wall outer face ...	1	8.40		.40	3.36	These can be taken approx in one operation as = (Total centre length) × (inner ht. + top width × outer ht.) = (8.65 + 2 × 2.50) × [.27 + .20 + (.27 + .10 + .03) = 13.65 × .87 = 11.88 sq
	Front wall inner face ...	1	8.00		.27	2.16	
	Front wall top face	1	8.40	.20		1.68	
	Side wall outer face	2	2.70		.40	2.16	
	Side wall inner face	2	2.50		.27	1.35	
	Side wall top face ...	2	2.50	.20		1.00	
					Total	152.20	
	<b>Deduct—</b>						
	Window openings (in outer walls) ...	8	1.00		1.50	12.00	One surface of each.
	C.S. window openings ...	12	1.00		0.50	6.00	One surface of each.
	Step from plinth wall ...	1	2.70		0.70	1.89	Including 10 cm below G.L.
	Ends of ver. side wall and lintel above col. level ...	2		.20	.60	0.24	This may be neglected.
	Ends of ver. parapet wall, from wall above ver. roof level	2		.20	.27	0.11	This may be neglected.
			Total of	deductions		20.24	
			Net	Total		131.96	Total of outside plastering
			Grand outside	Total of inside plastering =		285.60	and sq m
	<b>20 mm thick cement plaster 1:3 in step finished cement rendered —</b>						
	1st step riser ...	1	4.50	—	.15	} = 1.49	Front and sides.
	2nd step riser ...	1	3.30	—	.15		Front and sides.
	3rd step riser ...	1	2.10	—	.15		Front and sides.

Particulars of items and details of works	No.	Length m	Breadth m	Height or Depth m	Quantity	Explanatory notes
1st step tread ...	1	<u>3.90</u>		<u>.30</u>	} 2.43	Front and sides.
2nd step tread ...	1	<u>2.70</u>		<u>.30</u>		Front and sides.
3rd step tread ...	1	<u>1.50</u>		<u>.30</u>		Front and sides.
Plinth wall above						
1st step ...	2	<u>.30</u>		<u>.45</u>	0.27	Sides.
2nd step ...	2	<u>.30</u>		<u>.30</u>	0.18	Sides.
3rd step ...	1	<u>1.50</u>		<u>.15</u>	0.22	Sides.
				Total	4.59	
					sq m	
<b>2.5 cm thick c.c. 1 : 2 : 4 over and including 8 cm lime concrete floor—</b>						
Room (i) ...	1	<u>4.00</u>	<u>3.50</u>		14.00	
Room (ii) ...	1	<u>4.00</u>	<u>4.00</u>		16.00	
Verandah ...	1	<u>8.00</u>	<u>2.50</u>		20.00	Sills of verandah opening have been taken under item 20.
				Total	50.00	
					sq m	
<b>2.5 cm thick c.c. 1 : 2 : 4 floor in sills</b>						
Door sills ...	2	<u>1.20</u>	<u>.30</u>		0.72	
Sills of ver. opening front ...	1	<u>8.50</u>	<u>.25</u>		2.12	Including .05 m plinth outer offset. No. deduction for cols.
Sills of ver. opening sides ...	2	<u>2.50</u>	<u>.25</u>		1.25	
				Total	4.09	
Deduct pillars ...	4	$\pi \times (.15)^2$			0.07	This deduction may be neglected.
		4		Net		
				Total	4.02	
					sqm	

Particulars of items and details of works	No.	Length m	Breadth m	Height or Depth m	Quantity	Explanatory notes
<b>White washing</b> three coats inside — Walls	Same as for plastering	as for plastering	inside in item	wall (17) =	153.64	
Ceiling of room ...	1	4.00	3.50	—	14.00	
Ceiling of room ...	1	4.00	4.00	—	16.00	
Ceiling of ver. ...	1	8.00	2.50	—	20.00	
				Total	203.64 sq m	
<b>Colour washing</b> two coats over one coat of white washing outside — Walls	Same as for plastering	as for plastering	outside in item	wall (17) =	131.96	
Chujja ver. front	1	9.30	.95	—	8.84	Upper and lower faces and edges.
Chujja ver. sides	2	2.70	.95	—	5.13	Upper and lower faces and edges.
Sunshade and sun-breakers in windows —Top	4	2.50	.95	—	9.50	Upper and lower faces and edges.
Bottom	4	2.50	.25	—	2.50	" " " "
Sides	8 × 2	1.50	$\frac{.45 + .10}{2}$	—	6.60	Inner and outer faces.
Edges of sides	8	1.50	.05	—	0.60	This may be neglected.
Outer projection of roof slab	1	26.00	.36	—	9.36	L=Outer perimeter of room. B = .12 + .12+.12=.36 m
				Total	174.49	
Deduct portion below G.L.	1	29.10	—	.10	2.91	L=Outer perimeter—Steps = 2(8.50 + 7.40) - 2.70 = 29.10 m
			Net	Total	171.58 sq m	

# THREE ROOMED BUILDING WITH FRONT AND BACK VERANDAH

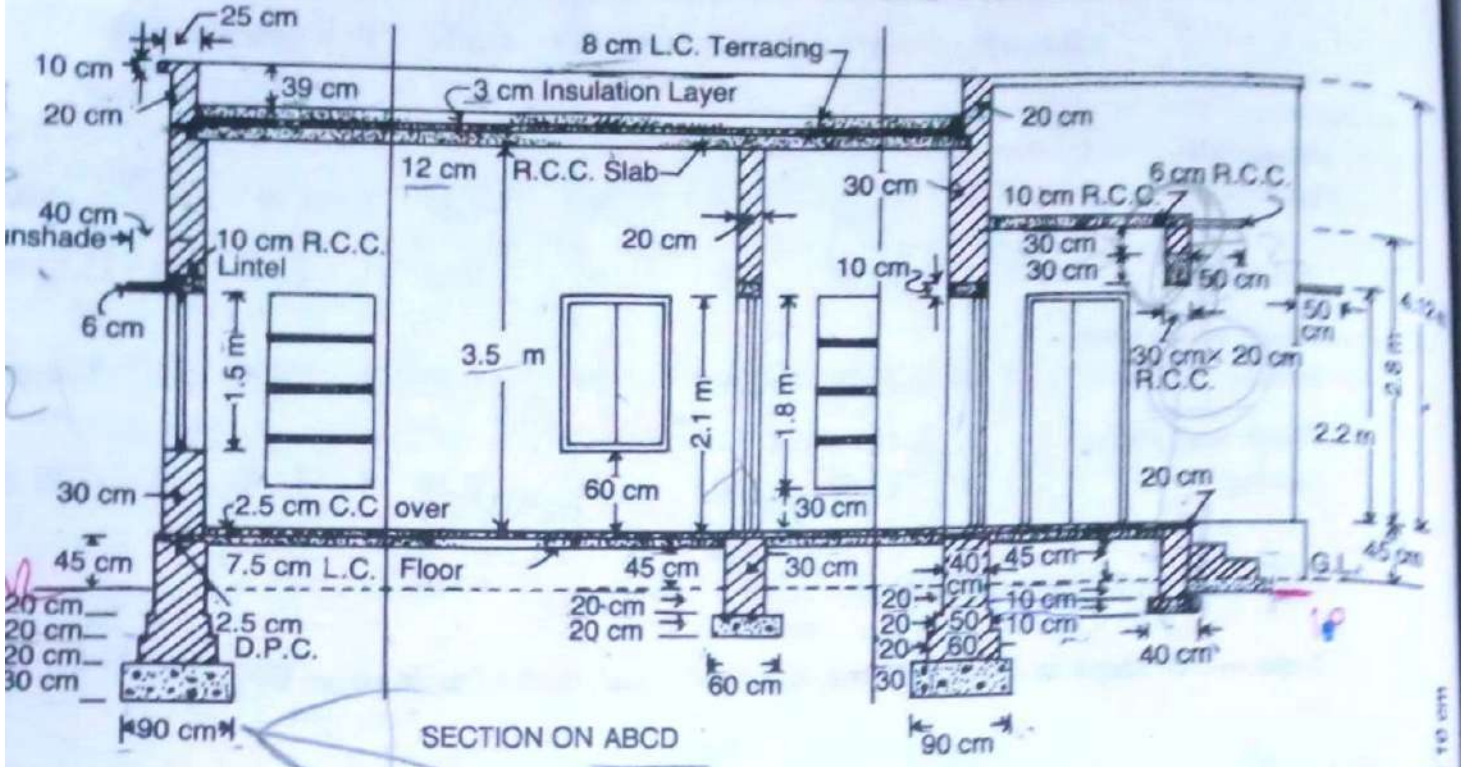

SECTION ON ABCD

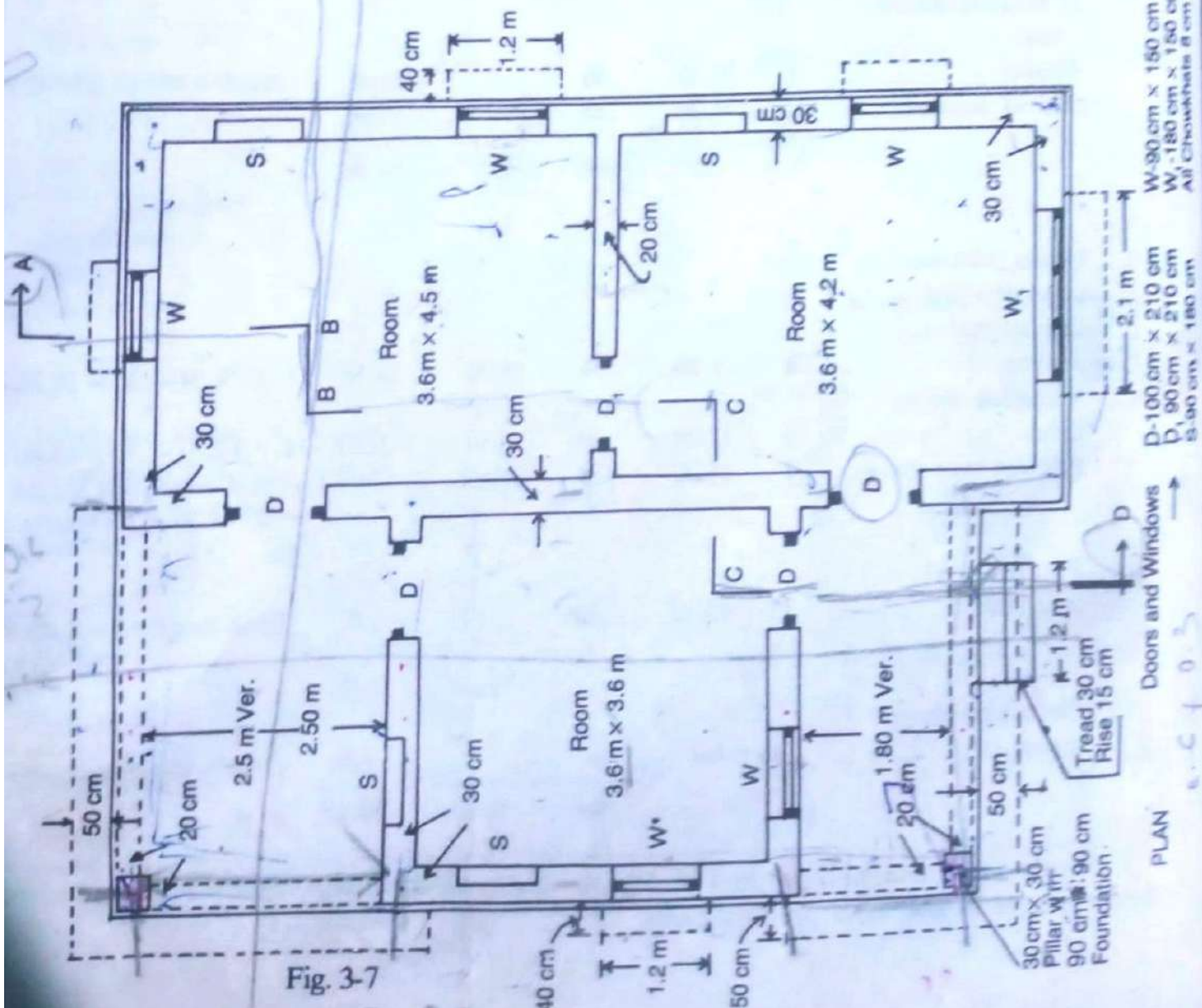

Fig. 3-7

PLAN

Centre to centre lengths of two adjoining rooms ( $3.6 \times 4.5$  m room and  $3.6 \times 4.2$  m room)  
 combined —  
 Long walls — 9.20 m, Short walls — 3.90 m.  
 Square room — ( $3.6 \times 3.6$  m room)  
 Long walls — 3.90 m, Short walls — 3.90 m.

Verandah. — Centre to centre of 30 cm wall and 30 cm sq pillar —  
 Front Verandah (1.80 m ver.) —  
 Long wall (Front) — 3.90 m, Short wall (Side) — 2.00 m.  
 Back Verandah (2.50 m ver.) —  
 Long wall (Back) — 3.90 m, Short wall (Side) — 2.70 m.

### DETAILS OF MEASUREMENT AND CALCULATION OF QUANTITIES (Ex.)

Item No.	Particulars of items and details of works	No.	Length m	Breadth m	Height or Depth m	Quantity	Explanatory notes
1.	<b>Earthwork in excavation in foundation—</b>						
	Adjoining room combined —						
	Long walls ...	2	10.10	0.90	0.90	16.36	$L = 9.20 + .90 = 10.10$ m
	Short walls ...	2	3.00	0.90	0.90	4.86	$L = 3.90 - .90 = 3.00$ m
	Inter 20 cm wall ...	1	3.00	0.60	0.40	0.72	$L = 3.90 - .90 = 3.00$ m
	Square room —						
	Long walls (outer) ...	1	4.80	0.90	0.90	3.88	$L = 3.90 + .90 = 4.80$ m
	Short walls ...	2	3.00	0.90	0.90	4.86	$L = 3.90 - .90 = 3.00$ m
	Verandah pillars ...	2	0.90	0.90	0.90	1.46	
	Verandah dwarf wall—Long walls (front and back) ....	2	3.00	0.40	0.20	0.48	$L = 3.90 - .90 = 3.00$ m
	Short wall front (side) ...	1	1.10	0.40	0.20	0.09	$L = 2.00 - .90 = 1.10$ m
	Short wall back (side) ...	1	1.80	0.40	0.20	0.15	$L = 2.70 - .90 = 1.80$ m
	Step ...	1	1.20	0.70	0.10	0.08	
						<b>Total</b>	
						32.94	cu m

Item No.	Particulars of items and details of works	No.	Length m	Breadth m	Height or Depth m	Quantity	Explanatory notes
2.	<b>Lime concrete in foundation—</b>						
	Adjoining room combined —						
	Long walls ...	2	10.10	0.90	0.30	5.45	L same as in item (1).
	Short walls ...	2	3.00	0.90	0.30	1.62	L same as in item (1).
	Inter 20 cm wall ...	1	3.40	0.60	0.20	0.41	$L = 3.90 - .50 = 3.40$ m
	Square room —						
	Long wall (outer) ...	1	4.80	0.90	0.30	1.30	$L = 3.90 + .90 = 4.80$ m
	Short walls ...	2	3.00	0.90	0.30	1.62	$L = 3.90 - .90 = 3.00$ m
	Verandah pillars ...	2	0.90	0.90	0.30	0.49	
	Verandah dwarf wall—						
	Long walls (front and back) ...	2	3.50	0.40	0.10	0.28	$L = 3.90 - .40 = 3.50$ m
	Short walls front (side) ...	1	1.60	0.40	0.10	0.064	$L = 2.00 - .40 = 1.60$ m
	Short walls back (side) ...	1	2.30	0.40	0.10	0.092	$L = 2.70 - .40 = 2.30$ m
	Step ...	1	1.20	0.70	0.10	0.084	
					Total	11.41	cu m
3.	<b>I-class brick work in lime mortar in foundation and plinth —</b>						
	Adjoining rooms combined —						
	Long walls —						
	1st footing ...	2	9.80	0.60	0.20	2.35	$L = 9.20 + .60 = 9.80$ m
	2nd footing ...	2	9.70	0.50	0.20	1.94	$L = 9.80 - .10 = 9.70$ m
	Plinth wall ...	2	9.60	0.40	0.65	4.99	$L = 9.70 - .10 = 9.60$ m
	Short walls —						
	1st footing ...	2	3.30	0.60	0.20	0.79	$L = 3.90 - .60 = 3.30$ m
	2nd footing ...	2	3.40	0.50	0.20	0.68	$L = 3.30 + .10 = 3.40$ m
	Plinth wall ...	2	3.50	0.40	0.65	1.82	$L = 3.40 + .10 = 3.50$ m
Inter 20 cm wall—							
Plinth wall ...	1	3.50	0.30	0.65	0.68	$L = 3.90 - .40 = 3.50$ m	
				C.O.	13.25		

Item No.	Particulars of items and details of works	No.	Length m	Breadth m	Height or Depth m	Quantity	Explanatory notes
					B.F.	13.25	
	Square room in Between verandah—						
	Long wall (outer)—						
	1st footing ...	1	4.50	0.60	0.20	0.54	L = 3.90 + .60 = 4.50 m
	2nd footing ...	1	4.40	0.50	0.20	0.44	L = 4.50 - .10 = 4.40 m
	Plinth wall ...	1	4.30	0.40	0.65	1.12	L = 4.40 - .10 = 4.30 m
	Short walls —						
	1st footing ...	2	3.30	0.60	0.20	0.79	L = 3.90 - .60 = 3.30 m
	2nd footing ...	2	3.40	0.50	0.20	0.68	L = 3.30 + .10 = 3.40 m
	Plinth wall ...	2	3.50	0.40	0.65	1.82	L = 3.40 + .10 = 3.50 m
	Verandah Pillars						
	1st footing ...	2	0.60	0.60	0.20	0.15	
	2nd footing ...	2	0.50	0.50	0.20	0.10	
	Plinth wall ...	2	0.40	0.40	0.65	0.21	
	Verandah dwarf walls —						
	Long walls front and back ...	2	3.50	0.20	0.55	0.77	L = 3.90 - .40 = 3.50 m
	Short side wall (front) ...	1	1.60	0.20	0.55	0.18	L = 2.00 - .40 = 1.60 m
	Short side wall (back) ...	1	2.30	0.20	0.55	0.25	L = 2.70 - .40 = 2.30 m
	Step —						
	1st step ...	1	1.20	0.60	0.15	0.11	
	2nd step ...	1	1.20	0.30	0.15	0.05	
					Total	20.46	
						cu m	
4.	<b>2.5 cm damp proof course—</b>						
	Adjoining room combined—						
	Long walls ...	2	9.60	0.40	—	7.68	L same as plinth wall.
	Short walls ...	2	3.50	0.40	—	2.80	
	Inter 20 cm wall ...	1	3.50	0.30	—	1.05	
	Square room —						
	Long wall (outer) ...	1	4.30	0.40	—	1.72	
	Short walls ...	2	3.50	0.40	—	2.80	
	Verandah Pillars ...	2	0.40	0.40	—	0.32	
					Total	16.37	
	Deduct Door Sills — D ...	4	1.00	0.40	—	1.60	
	D <sub>1</sub> ...	1	0.90	0.30	—	0.27	
					Total of deductions	1.87	
				Net	Total	14.50	
						sq m	



Item No.	Particulars of items and details of works	No.	Length m	Breadth m	Height or Depth m	Quantity	Explanatory notes
5.	<b>1st class brick-work in 1 : 6 cement mortar in super-structure —</b>						
	Adjoining rooms combined —						
	Long walls ...	2	9.50	0.30	3.62	20.63	Ht. up to top of slab.
	Short walls ...	2	3.60	0.30	3.62	7.82	Ht. up to top of slab.
	Inter 20 cm wall ...	1	3.60	0.20	3.50	2.52	Ht. up to bottom of slab.
	Square room in between verandah —						
	Long wall (outer)	1	4.20	0.30	3.62	4.56	$L = 3.90 + .30 = 4.20 \text{ m}$
	Short walls ...	2	3.60	0.30	3.62	7.82	$L = 3.90 - .30 = 3.60 \text{ m}$
	Verandah pillars	2	0.30	0.30	2.80	0.50	
	Verandah 20 cm wall above lintel—						
	Long wall (front and back)	2	3.60	0.20	0.30	0.43	
	Short wall front (side) ...	1	1.70	0.20	0.30	0.10	
	Short wall back (side) ...	1	2.40	0.20	0.30	0.14	
	<b>Parapet —</b>						
	Adjoining rooms —						
	Outer long wall (out to out)	1	9.50	0.20	0.50	0.95	Ht. of parapet = $.39 + .08 + .03 = 0.50 \text{ m}$
	Short walls	2	4.00	0.20	0.50	0.80	$L = 9.20 + .30 = 9.50 \text{ m}$ $L = 3.60 + .30 + .10 = 4.00 \text{ m}$
	Front verandah side	1	2.40	0.20	0.50	0.24	$L = 1.80 + .60 = 2.40 \text{ m}$
	Back verandah side	1	2.50	0.20	0.50	0.25	$L = 2.50 + .20 - 0.20 = 2.50 \text{ m}$
	Square room-outer wall ...	1	4.20	0.20	0.50	0.42	$L = 3.60 + .60 = 4.20 \text{ m}$
	Walls in between ver. and room ...	2	3.90	0.20	0.50	0.78	$L = 3.60 + .20 + .10 = 3.90 \text{ m}$
					Total	47.96	
						cu m	

Note. — Parapet is out

Item No.	Particulars of items and details of works	No.	Length m	Breadth m	Height or Depth m	Quantity	Explanatory notes
<b>Deduct —</b>							
	Door openings —	4	1.00	0.30	2.10	2.52	
	D	1	0.90	0.20	2.10	0.38	
	Window openings	5	0.90	0.30	1.50	2.02	
	W	1	1.80	0.30	1.50	0.81	
	W <sub>1</sub>	4	0.90	0.20	1.80	1.30	
	Shelves						
	Lintels over doors, windows and shelves ...		Same marked	as for (a)	item 6 ...	0.567	Bearing of roof slab not deducted may be deducted, if specified
			Total of	deduc-	tions	7.60	
				Net	Total	40.36 cu m	
<b>R.C.C. work</b>							
1 : 2 : 4 excluding steel and its bending, but including centering and shuttering and binding steel							
	Roof slab —						
	Adjoining rooms combined ...	1	9.20	3.90	0.12	4.306	Bearing 15 cm
	Square room ...	1	3.90	3.90	0.12	1.825	Bearing 15 cm
	Verandah front ...	1	4.05	2.15	0.10	0.871	Bearing 15 cm
	Verandah back ...	1	4.05	2.85	0.10	1.154	
	Verandah Chujja —						
	Front and back long ...	2	4.55	0.50	0.06	0.273	
	Side (front)	1	2.15	0.50	0.06	0.065	
	Side (back) ...	1	2.85	0.50	0.06	0.085	
	Sunshades over windows —						
	W ...	4	1.20	0.40	0.06	0.115	
	W <sub>1</sub> ...	1	2.10	0.40	0.06	0.050	
					C.O.	8.744	

Item No.	Particulars of items and details of works	No.	Length m	Breadth m	Height or Depth m	Quantity	Explanatory notes
					B.F.	8.744	
	Lintels over doors, windows, shelves—						
	Doors D ...	4	1.30	0.30	0.10	0.156 (a)	Bearing 15 cm
	Doors D <sub>1</sub> ...	1	1.20	0.20	0.10	0.024 (a)	Total of (a) s = 0.567 cu m
	Windows W ...	5	1.20	0.30	0.10	0.180 (a)	
	Windows W <sub>1</sub> ...	1	2.10	0.30	0.10	0.063 (a)	
	Shelves S ...	4	1.20	0.30	0.10	0.144 (a)	
	Verandah lintels						
	Front and back long ...	2	4.10	0.20	0.30	0.492	Bearing over wall 20 cm
	Side (front)	1	2.00	0.20	0.30	0.120	
	Side (back)	1	2.70	0.20	0.30	0.162	
					Total	10.085 cu m	

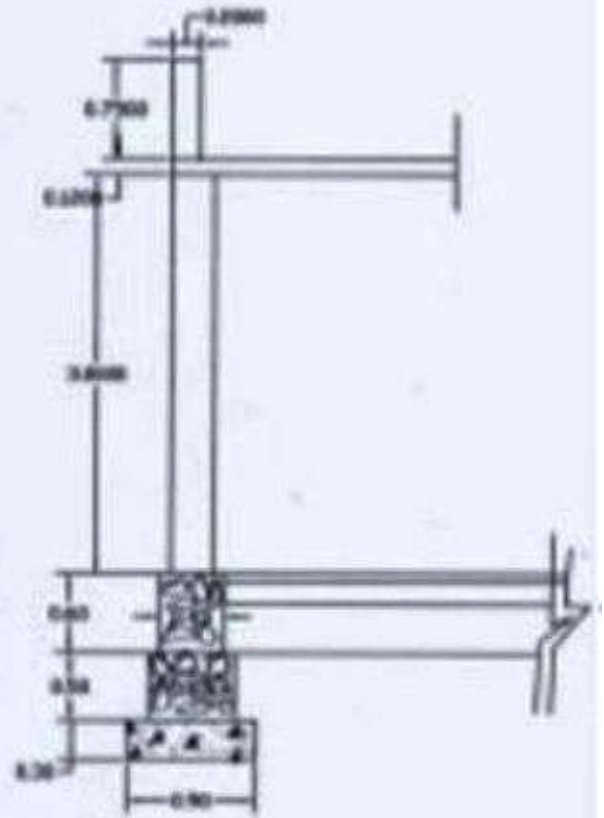
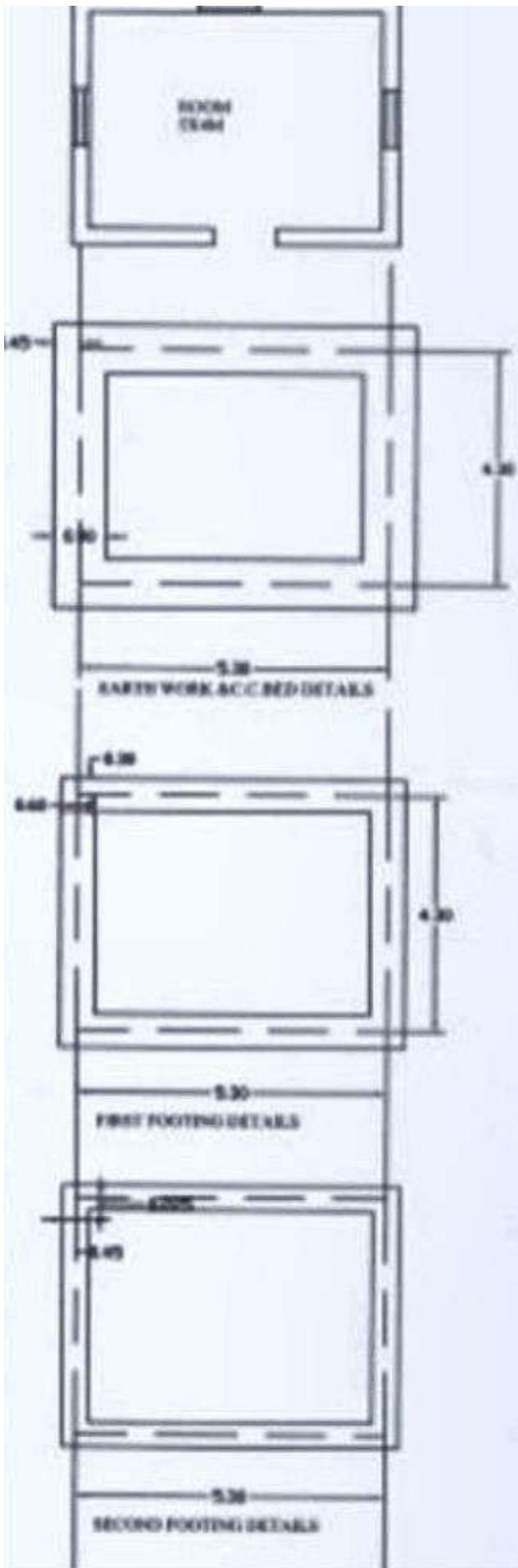

CROSS SECTION AT X-X

Note: All Dimensions are in 'M'

D=1X2.1M

W=1.5X1.2M

**Example 2.8:** From the given figure below calculate the detailed and abstract estimate for the single roomed building (Load bearing type structure) by

- a) long wall & short wall method
- b) Centre Line Method

a) Long wall - Short Method

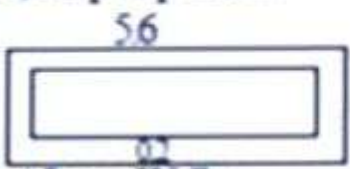
S.No	Particulars of Items	No	L	B	H	Q	Explanation
1.	<b>Earth Work excavation for foundation</b>						
	a) Long walls	2	6.2	0.9	1.4	15.264	$L=5.3+0.45+0.45=6.2$ $D=0.3+0.5+0.6=1.4$
	b) Short walls	2	3.4	0.9	1.4	8.568	$L=4.3-0.45-0.45=3.4$
					<b>Total</b>	<b>24.192</b>	<b>m<sup>3</sup></b>
2.	<b>C.C.(1:4:8) bed for foundation</b>						
	a) Long walls	2	6.2	0.9	0.3	3.348	
	b) Short walls	2	3.4	0.9	0.3	1.836	
					<b>Total</b>	<b>5.184</b>	<b>m<sup>3</sup></b>
3.	<b>R.R.Masonry in CM (1:6) for</b>						
	a) Footings						
	i) Long walls	2	5.9	0.6	0.5	3.54	$L=5.3+0.3+0.3=5.9$
	ii) Short walls	2	3.7	0.6	0.5	2.22	$L=4.3-0.3-0.3=3.7$
					<b>Total</b>	<b>5.76</b>	<b>m<sup>3</sup></b>
	b) Basement						
	i) Long walls	2	5.75	0.45	0.6	3.105	$L=5.3+0.225+0.225=5.75$
	ii) Short walls	2	3.85	0.45	0.6	2.079	$L=4.3-0.225-0.225=3.85$
					<b>Total</b>	<b>5.184</b>	<b>m<sup>3</sup></b>
	<b>Total R.R. Masonry for footings and Basement</b>						<b>= 5.76+5.184 = 10.94 m<sup>3</sup></b>
4.	<b>Brick masonry with CM (1:6) for super structure</b>						
	a) Long Walls	2	5.6	0.30	3.00	10.08	$L=5.3+0.15+0.15=5.6$
	b) Short walls	2	4.0	0.30	3.00	7.20	$L=4.3-0.15-0.15=4.0$
	c) for parapet wall						
							
	a) Long Walls	2	5.6	0.2	0.75	1.68	
	b) Short walls	2	4.4	0.2	0.75	1.32	
					<b>Total</b>	<b>20.28</b>	<b>m<sup>3</sup></b>

S.No.	Particulars of Items	No.	L	B	H	Q	Explanation
	Deductions for openings						
	a) Doors	1	1.0	0.3	2.1	0.63	
	b) Windows	3	1.5	0.3	1.2	1.62	
					<b>Total</b>	<b>(-)2.25</b>	<b>m<sup>3</sup></b>
	<b>Net Brick Masonry</b>		<b>= 20.28</b>			<b>- 2.25 =</b>	<b>18.03m<sup>3</sup></b>
5.	<b>R.C.C. (1:2:4) for</b>						
	a) Roof slab	1	5.6	4.6	0.12	3.090	
	b) Lintels over						
	i) Doors	1	1.2	0.3	0.15	0.054	
	ii) Windows	3	1.5	0.3	0.15	0.202	
	c) Beams						
	i) Long beams	2	5.6	0.3	0.3	1.008	
	ii) short beams	2	4.0	0.3	0.3	0.720	
					<b>Total</b>	<b>5.074</b>	<b>m<sup>3</sup></b>
6.	Sandfilling for basement	1	4.85	3.85	0.48	8.96	L=5.0-0.075-0.075=4.85
7	C.C.(1:4:8) for flooring	1	4.85	3.85	0.1	1.86	B=4.0-0.075-0.075=3.85
8	Flooring with Mosaic tiles	1	5.0	4.0	--	20.0	<b>m<sup>2</sup></b>
9	Plastering with CM (1:6)for super structure						
	<u>Inside</u>						
	Forwalls	1	18.0	--	3.0	54.0	L=2(5.0+4.0)=18.0
	<u>Out side</u>						
	Forwalls	1	20.4	--	3.87	61.2	L=2(5.6+4.6)=20.4
	Basement outside	1	21.6	--	0.6	12.96	H=3.0+0.12+0.75=3.87 (upto parapet wall)
	Parapet wall						
	a) Inside	1	18.8	--	0.75	14.1	
	b) top	1	19.6	0.2	---	3.92	
	Deductions for openings				<b>Total</b>	<b>146.18</b>	<b>m<sup>2</sup></b>
	Doors	1x2	1.0	--	2.1	4.2	
	Windows	3x2	1.5	--	1.2	10.8	
						<b>15.0</b>	<b>m<sup>2</sup></b>
	<b>Net Plastering</b>		<b>= 146.18</b>			<b>- 15.0</b>	<b>= 131.18 m<sup>2</sup></b>

S.No.	Particulars of Items	No.	L	B	H	Q	Explanation
10	Plastering for Ceiling with CM(1:5)	1	5.0	4.0	--	20.0	m <sup>2</sup>
11	White Washing with two coats with Janatha cement						
	Same as quantity of plastering for walls and ceiling					151.18	(=131.18+20=151.18)
12	Colour washing with two coats						
	Same as quantity of plastering for walls and ceiling					151.18	(=131.18+20)151.18)
13	Supply & Fixing of best country wood for						
	a) Doors	1				1 No.	
	b) Windows	3				3No.	
14	Painting with ready mixed synthetic enamel paints with two coats over primary coat for new wood for						
	a) Doors	2½x1	1.0	---	2.1	4.725	
	b) Windows	2½x3	1.5	---	1.2	12.15	
					Total	16.875	m <sup>2</sup>
15	Petty supervision and contingencies at 4% and rounding off						



S.No.	Particulars of Items	No.	L	B	H	Q	Explanation
1.	Earth Work excavation for foundation 5.3  4.3	1	19.2	0.9	1.4	24.192	m <sup>3</sup> $L=2(5.3+4.3)=19.2$
2.	C.C.(1:4:8) bed for foundation	1	19.2	0.9	0.3	5.184	m <sup>3</sup>
3.	R.R.Masonry in CM (1:6) for						
	a) Footings	1	19.2	0.6	0.5	5.76	
	b) Basement	1	19.2	0.45	0.6	5.184	
					Total	<u>10.944</u>	
4.	Brick masonry with CM(1:6) for super structure	1	19.2	0.3	3.0	17.28	m <sup>3</sup>
	For parapet wall	1	20.0	0.2	0.75	3.00	
	Deductions for openings						
	a) Doors	1	1.0	0.3	2.1	0.63	
	b) Windows	3	1.5	0.3	1.2	1.62	
					Total	<u>(-)2.25</u>	m <sup>3</sup>
	Net Brick Masonry =		17.28	+3.0	-2.25	=	18.03 m <sup>3</sup>
5.	R.C.C. (1:2:4) for						
	a) roof slab	1	5.6	4.6	0.12	3.090	
	b) Lintels over						
	i) Doors	1	1.2	0.3	0.15	0.054	
	ii) Windows	3	1.5	0.3	0.15	0.202	
	c) beams	1	19.2	1.3	0.3	1.728	
					Total	<u>5.074</u>	m <sup>3</sup>
6.	Sandfilling for basement	1	4.85	3.85	0.48	8.96	$L=5.0-0.075-0.075=4.85$
7.	C.C.(1:4:8) for flooring	1	4.85	3.85	0.1	1.86	$B=4.0-0.075-0.075=3.85$

8.	flooring with Mosaic tiles	1	5.0	4.0	--	20.0	
9	Plastering with CM (1:6)for super structure <b>Inside</b>						
	Forwalls	1	18.0	--	3.0	54.0	
	<b>Out side</b>						
	Forwalls	1	20.4	--	3.87	61.2	
	Basement outside	1	21.6	--	0.6	12.96	
	Parapet wall						
	a) Inside	1	18.8	--	0.75	14.1	
	b) top	1	19.6	0.2	---	3.92	
	<b>Deductions for opeinings</b>				<b>Total</b>	<b>146.18</b>	<b>m<sup>2</sup></b>
	Doors	1x2	1.0	--	2.1	4.2	L=5.0-0.075-0.1
	Windows	3x2	1.5	--	1.2	10.8	B=4.0-0.075-0
						<b>15.0</b>	<b>m<sup>2</sup></b>
	<b>Net Plastering =</b>		<b>146.18-15</b>	<b>=</b>		<b>131.18</b>	<b>m<sup>2</sup></b>
10	Plastering for Ceiling with CM(1:5)	1	5.0	4.0	--	20.0	<b>m<sup>2</sup></b>
11	White Washing with two coats with Janatha cement						
	Same as quantity of plastering for walls and ceiling					151.18	<b>m<sup>2</sup></b> (131.18+20=151)
12.	Colour washing with two coats						
	Same as quantity of plastering for walls and ceiling					151.18	<b>m<sup>2</sup></b>
13	Supply & Fixing of best country wood for						
	a) Doors	1				1 No.	
	b) Windows	3				3No.	

Abstract estimate of single roomed building (load bearing structure)

No.	Description of item	Quantity	Unit	Rate	Per	Amount
1.	Earth work excaation	24.192	m <sup>3</sup>	465	10m <sup>3</sup>	1125.00
2.	Cement concrete(1:4:8)	5.184	m <sup>3</sup>	4545	1m <sup>3</sup>	8009.30
3.	RR masonry in C.M.(1:5)	10.94	m <sup>3</sup>	1391	m <sup>3</sup>	15217.50
4.	Sand filling in basement	8.96	m <sup>3</sup>	195.20	10m <sup>3</sup>	175.00
5.	Brick masonry in country bricks of standard size in CM(1:8)	18.03	m <sup>3</sup>	2291	m <sup>3</sup>	41306.73
6.	R.C.C. (1:2:4) for lintels, beams etc.	1.984	m <sup>3</sup>	6030	m <sup>3</sup>	11963.52
7.	R.C.C. (1:2:4) for slabs,	3.09	m <sup>3</sup>	6030	m <sup>3</sup>	18633.00
8.	Cement concrete (1:5:10) for flooring	1.86	m <sup>3</sup>	1452	m <sup>3</sup>	2700.72
9.	Supplying and fixing of country wood for doors.	2.1	m <sup>2</sup>	1650	m <sup>2</sup>	3465.00
10.	Supplying and fixing of country wood for windows and ventilators.	5.4	m <sup>2</sup>	2300	m <sup>2</sup>	12420.00
11.	Plastering to all exposed surfaces of brick work and basement with C.M (1:5)	151.18	m <sup>2</sup>	582	10m <sup>2</sup>	8798.70
12.	White washing with best shell lime	151.18	m <sup>2</sup>	116	10m <sup>2</sup>	1753.68
13.	Flooring with spartek tiles set in C.M (1:3)	20	m <sup>2</sup>	4230	10m <sup>2</sup>	8460.00
14.	Painting with ready mixed enamel paint	16.875	m <sup>2</sup>	335	10m <sup>2</sup>	565.31
					<b>Total</b>	<b>134593.46</b>
15.	Provision for water supply and sanitary arrangements @12.5%					16824.18
16.	Provision for electrification @7.5%					10094.50
17.	Provision for architectural appearance @2%					2691.86
18.	Provision for unforeseen items 2%					2691.86
19.	Provision for P.s and contingencies @4%					5383.73
					<b>Grand Total Rs.</b>	<b>172279.65</b>

**Example :2.9** From the given figure below calculate the details and abstract estimate for the double roomed building (Load bearing type structure) by a) long wall & short wall method

(b) Centre Line Method

TWO ROOMED BUILDING  
(LOAD BEARING TYPE STRUCTURE)

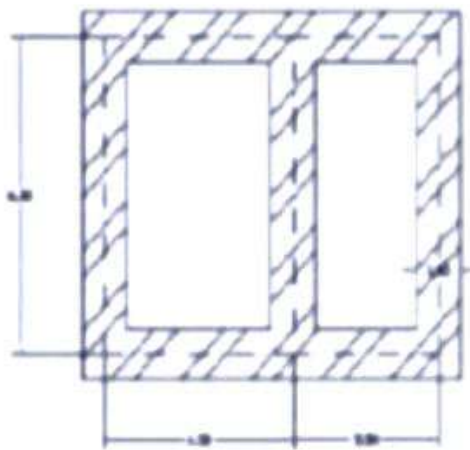
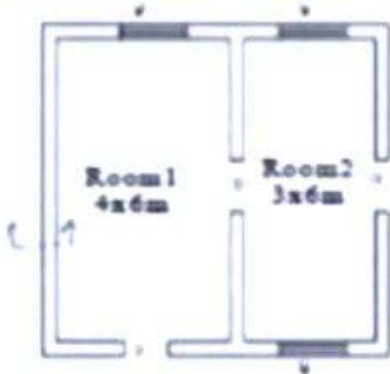

Plan for first flooring

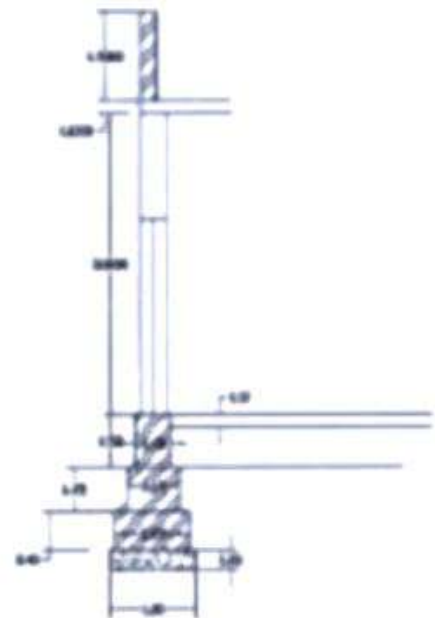
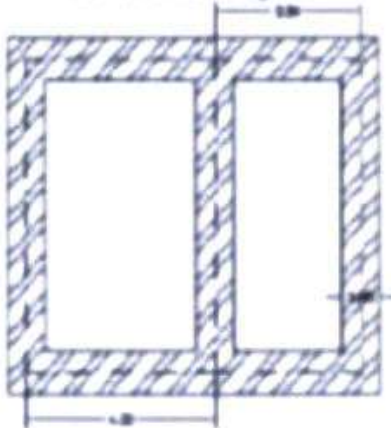

D=1.2  
W=1.5x1.2

Note: All Dimensions are in M

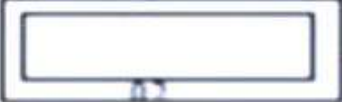
S.No	Particulars of Items	No	L	B	H	Q	Explanation
1.	<b>Earth Work excavation for foundation</b>						
	a) Long walls	2	8.6	1.0	1.05	18.05	$L=7.6+0.5+0.5=8.6$
	b) Short walls	3	5.3	1.0	11.05	16.70	$L=6.3-0.5-0.5=5.3$
					Total	34.75	$m^3$
2.	<b>C.C.(1:4:8) bed for foundation</b>						
	a) Long walls	2	8.6	1.0	0.2	3.44	
	b) Short walls	3	5.3	1.0	0.2	3.18	
					Total	6.62	$m^3$
3.	<b>Brick masonry for footings with CM(1:4) first footing</b>						
	a) Longwalls	2	8.45	0.85	0.4	5.746	$L=7.6+0.425+0.425=8.45$
	b) Shortwalls	3	5.45	0.85	0.4	5.560	$L=6.3-0.425-0.425=5.45$
	<b>2nd footing</b>						
	a) Long walls	2	8.20	0.6	0.45	4.428	$L=7.6+0.3+0.3=8.2$
	b) short walls	3	5.70	0.6	0.45	4.617	$L=6.3-0.3-0.3=5.7$
	<b>ii) for base ment</b>						
	long walls	2	8.00	0.4	0.4	2.560	$L=7.6+0.2+0.0=8.0$
	short walls	3	5.90	0.4	0.4	2.832	$L=6.3-0.2-0.2=5.9$
	<b>iii) for super structure</b>						
	long walls	2	7.90	0.3	3.0	14.22	$L=7.6+0.15+0.15=7.9$
	short walls	3	6.00	0.3	3.0	16.20	$L=6.3-0.15-0.15=6.0$
	<b>iv) Parapet wall</b>						
	79						
							
	a) long walls	2	7.90	0.2	0.70	2.212	
	b) Shot walls	2	6.20	0.2	0.70	1.736	
					Total	60.11	
	<b>Deductions for openings</b>						
	Doors	3	1.0	0.3	2.1	1.89	
	Windows	3	1.5	0.3	1.2	1.62	
	Lintels over doors	3	1.20	0.3	0.10	0.108	
	windows	3	1.70	0.3	0.10	0.153	
	<b>Net B.M. = 60.11 - 3.77 = 56.34 m<sup>3</sup></b>				Total	3.771	

	a) roof slab	1	7.9	6.6	0.12	6.256	
	b) for lintels over doors	3	1.2	0.3	0.1	0.108	
	Windows	3	1.7	0.3	0.1	0.153	
	c) beams	1	33.8	0.3	0.3	3.042	
					Total	9.298	m <sup>3</sup>
5.	Plastering for walls	1	20.0	--	3.0	60.00	L=2(4.0+6.0)=20
	a) Inside room 1	1	18.0	---	3.0	54.00	
	room 2	1	29.0	---	3.0	87.00	L=2(7.9+6.6)=29
	b) out side	1×2	28.2	---	0.70	39.48	L=2(7.7+6.4)=28.2
	Parapet wall(Sides)	1×1	28.2	0.20	--	5.64	
					Total	246.12	m <sup>2</sup>
	Deductions						
	a) doors	3×2	1.0	---	2.10	12.6	
	b) windows	3×2	1.5		1.20	10.8	
					Total	23.4	m <sup>2</sup>
	Net Plastering				= 246.12 - 23.4 =	222.72	m <sup>2</sup>
6.	flooring with cudepeh slab in cm (1:3)						
	Room 1	1	4.0	6.0	---	24	
	Room 2	1	3.0	6.0	---	18	
					Total	42	m <sup>2</sup>
7	Plastering for ceiling = same as flooring					42	
8	White washing = same as plastering for walls & Ceiling						
					= 222.72 + 42 =	264.72	m <sup>2</sup>
9	Colour washing with two coats						
	Same as quantity of plastering for walls and ceiling					264.72	m <sup>2</sup>
10	Supply & Frang of best country wood for						
	a) Doors	3				3 Nos.	
	b) Windows	3				3 Nos	
11	Painting with ready mixed synthetic enamel paints two coats over primary coat for new wood for						
	a) Doors	2 1/2 × 3	1.0	--		14.175	
	b) Windows	2 1/2 × 3	1.5	--		11.13	
						25.305	m <sup>2</sup>
12	2% unforeseen items						
13	4% PS& contingencies and round off.						

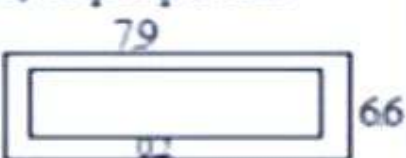
S.No.	Particulars of Items	No.	L	B	H	Q	Explanation
							
	<p>Total centre line length  <math>= (4.3 + 3.3) \times 2 + 6.3 \times 3 = 34.1 \text{ m}</math></p>						
1.	Earth work excavation	1	33.1	1.0	1.05	34.75	$L = 34.1 - 2 \times 1/2 = 33.1 \text{ m}^3$
2.	C.C.(1:4:8) bed for foundation	1	33.1	1.0	0.20	6.62	
3.	Brick masonry with CM(1:4)						
	a) for foundation						
	i) first footing	1	33.25	0.85	0.40	11.30	$L = 34.1 - 0.85 = 33.25$
	ii) 2nd footing	1	33.50	0.60	0.45	9.045	$L = 34.1 - 0.6 \times 2/2$
	b) for basement	1	33.7	0.40	0.40	5.392	$L = 34.1 - 0.4 \times 2/2$
	c) for super structure	1	33.80	0.30	3.0	30.42	$L = 34.1 - 0.3 \times 2/2$
	d) for parapet wall						
				7.7		6.4	
	<p>Total centre line length  <math>= 2(7.7 + 6.4) = 28.2</math></p>	1	28.2	0.2	0.70	3.948	
					Total	60.10	$\text{m}^3$
	Deductions for						
	Openings Doors	3	1.0	0.3	2.1	1.89	
	windows	3	1.5	0.3	1.2	1.62	
	Lintels Doors	3	1.2	0.3	0.1	0.108	
	Windows	3	1.7	0.3	0.1	1.153	
					Total	3.771	$\text{m}^3$
	Net B.M. = $60.11 - 3.771 = 56.34 \text{ m}^3$						
4.	Quantity of R.C.C. Roof, Plastering for walls and ceiling and flooring. White washing is same as Long wall & Short wall method.						

**Example 2.10** From the given figure below calculate the details and abstract estimate for this single storied residential building with no of rooms (Load bearing type structure) by Centre Line Method

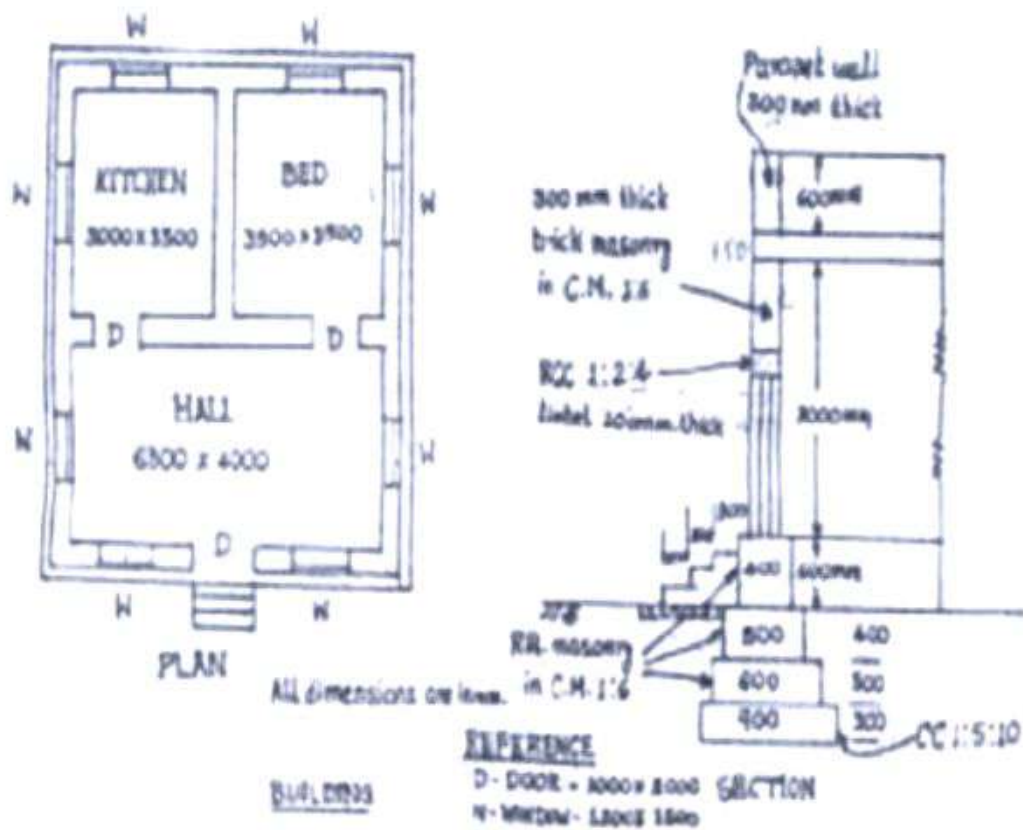

2. 22

Centre line diagram

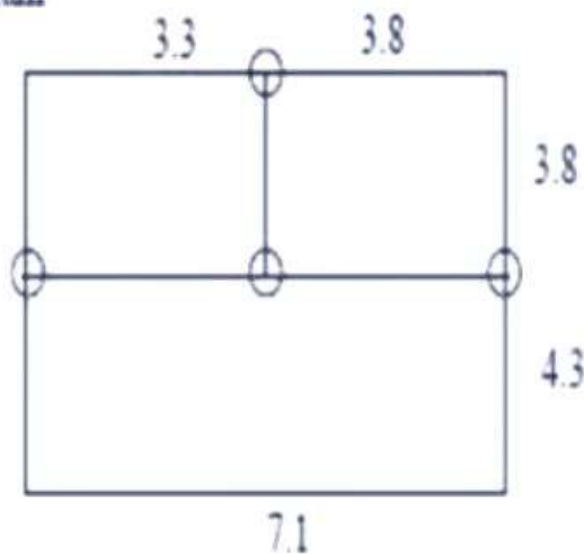

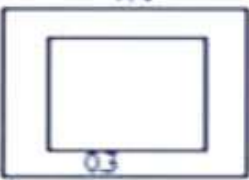

S.No.	Particulars of Items	No	L	B	H	Q	Explanation
1.	Earth work Excavation	1	39.5	0.9	1.0	35.55	$41.3-4 \times 0.9/2=39.5$
2.	C.C. bed (1:5:10)	1	39.5	0.9	0.3	10.665	$m^3$
3.	R.R. Masonry in CM 1:6						
	1st Footing	1	40.1	0.6	0.3	7.218	$41.3-4 \times 0.6/2=40.1$
	2nd Footing	1	40.3	0.5	0.4	8.06	$41.3-4 \times 0.5/2=40.3$
	Basement	1	40.5	0.4	0.6	9.72	$41.3-4 \times 0.4/2=40.5$
					Total	<b>25.00</b>	$m^3$
4.	Damp proof course over basement around the building with CC (1:2:4)	1	40.5	0.6	---	16.2	$m^2$
	Deduct for Door sills	3	1.0	0.3	---	- 0.9	$m^2$
	Net Quantity = $16.2 - 0.9 = 15.3$				---		$sq. m$
5.	First class brick work in wall in						
	a) superstructure with CM 1:6	1	40.7	0.3	3.0	36.63	$L = 41.3 - 4 \times 0.3/2$
	b) Parapet wall	1	30.4	0.3	0.6	5.472	$L = 2(7.1 + 8.1)$
			7.4	7.1	Total	<b>42.102</b>	$m^3$
			8.4	8.1			
							
	<u>Deductions:</u>						
	Doors	3	1.0	0.3	2.0	1.80	
	Windows	8	1.2	0.3	1.5	4.32	
	Lintel opening over						
	Doors	3	1.2	0.3	0.1	0.108	As per 100mm
	Windows	8	1.4	0.3	0.1	0.336	projection on either side
					Total	<b>6.564</b>	
	Net Quantity of BM = $42.102 - 6.564 = 35.538$						$m^3$
6.	Plastering with 12mmth in CM 1:5	1x2	40.1	---	3.0	240.6	$L = 41.3 - 4 \times 0.3 = 40.1$
	Deductions for openings						

S.No	Particulars of Items	No.	L	B	H	Q	Explanation
	Doors	3x2	1.0	---	2.0	12.0	
	windows	8x2	1.2	---	1.5	28.8	
					Total	40.8	m <sup>2</sup>
	Plastering for parapet wall (sides)	1x2	30.4	---	0.6	36.48	
	Top	1	30.4	0.3	---	9.12	
					Total	45.60	m <sup>2</sup>
	Net Plastering = 240.6 - 40.8 + 45.6 = 245.4 m <sup>2</sup>						
7.	Flooring with 25mmth CC(1:2:4)						
	Kitchen	1	3.0	3.5	--	10.5	
	Bed	1	3.5	3.5	--	12.25	
	Hall	1	6.8	4.0	--	27.20	
	Sills of Doors	3	1.0	0.3	--	0.90	
					Total	50.85	m <sup>2</sup>
8.	Ceiling = Same as Flooring					50.85	m <sup>2</sup>
9.	white washing = Same as Plastering for walls and ceiling 245.4 + 50.85 = 296.25 m <sup>2</sup>						
10.	RCC(1:2:4) for						
	a) Slab	1	7.40	8.40	1.5	9.324	
	b) lintels over Doors	3	1.2	0.3	0.1	0.108	
	Windows	8	1.4	0.3	0.1	0.336	
	c) beams	1	40.7	0.3	0.3	3.663	
					Total	13.431	m <sup>3</sup>
11.	Supply & Fixing of best country wood for						
	a) Doors	3				3Nos.	
	b) Windows	8				8 Nos	
12.	Painting with ready mixed synthetic enamel paints two coats over primary coat for new wood for						
	a) Doors	2 1/2 x 3	1.0	--	2.0	13.50	
	b) Windows	2 1/2 x 8	1.2	--	1.5	32.40	
						45.90	m <sup>2</sup>
13.	2% unforeseen items						
14.	4% P.S.& contingencies and round off						

Abstract estimate of single storeyed residential building with no of rooms (lead beary type)

S.No.	Description of item	Quantity	Unit	Rate	Per	Amount
1.	Earth work excavation	35.55	m <sup>3</sup>	465	10m <sup>3</sup>	1653.00
2.	Cement concrete(1:4:8)	10.665	m <sup>3</sup>	1545	1m <sup>3</sup>	164.77.50
3.	RR.masonry in C.M.(1:5)	25.00	m <sup>3</sup>	1391	m <sup>3</sup>	34775.00
4.	Sand filling in basement	23.775	m <sup>3</sup>	195.20	10m <sup>3</sup>	464.00
5.	Brick masonry in country bricks of standard size in CM(1:8)	35.535	m <sup>3</sup>	2291	m <sup>3</sup>	81417.60
6.	R.C.C. (1:2:4) for lintels, beams etc.	4.107	m <sup>3</sup>	6030	m <sup>3</sup>	24765.20
7.	R.C.C.(1:2:4) for slabs,	9.324	m <sup>3</sup>	6030	m <sup>3</sup>	56223.70
8.	Cement concrete (1:5:10) for flooring	5.085	m <sup>3</sup>	1452	m <sup>3</sup>	7383.40
9.	Supplying and fixing of country wood for doors.	6.00	m <sup>2</sup>	1650	m <sup>2</sup>	9900.00
10.	Supplying and fixing of country wood for windows and ventilators.	14.40	m <sup>2</sup>	2300	m <sup>2</sup>	33120.00
11.	Plastering to all exposed surfaces of brick work and basement with C.M (1:5)	245.40	m <sup>2</sup>	582	10m <sup>2</sup>	14282.30
12.	White washing with best shell lime	296.25	m <sup>2</sup>	116	10m <sup>2</sup>	3436.50
13.	Flooring with spartek tiles set in C.M (1:3)	50.85	m <sup>2</sup>	4230	10m <sup>2</sup>	21509.50
14.	Painting with ready mixed enamel paint	45.90	m <sup>2</sup>	335	10m <sup>2</sup>	1537.65
						<u>306945.35</u>
15.	Provision for water supply and sanitary arrangements @12.5%					38368.20
16.	Provision for electrification @7.5%					23020.90
17.	Provision for architectural appearance @2%					6138.90
18.	Provision for unforeseen items 2%					6138.90
19.	Provision for P.S and contingencies @4%					12277.80
						<u>392890.00</u>

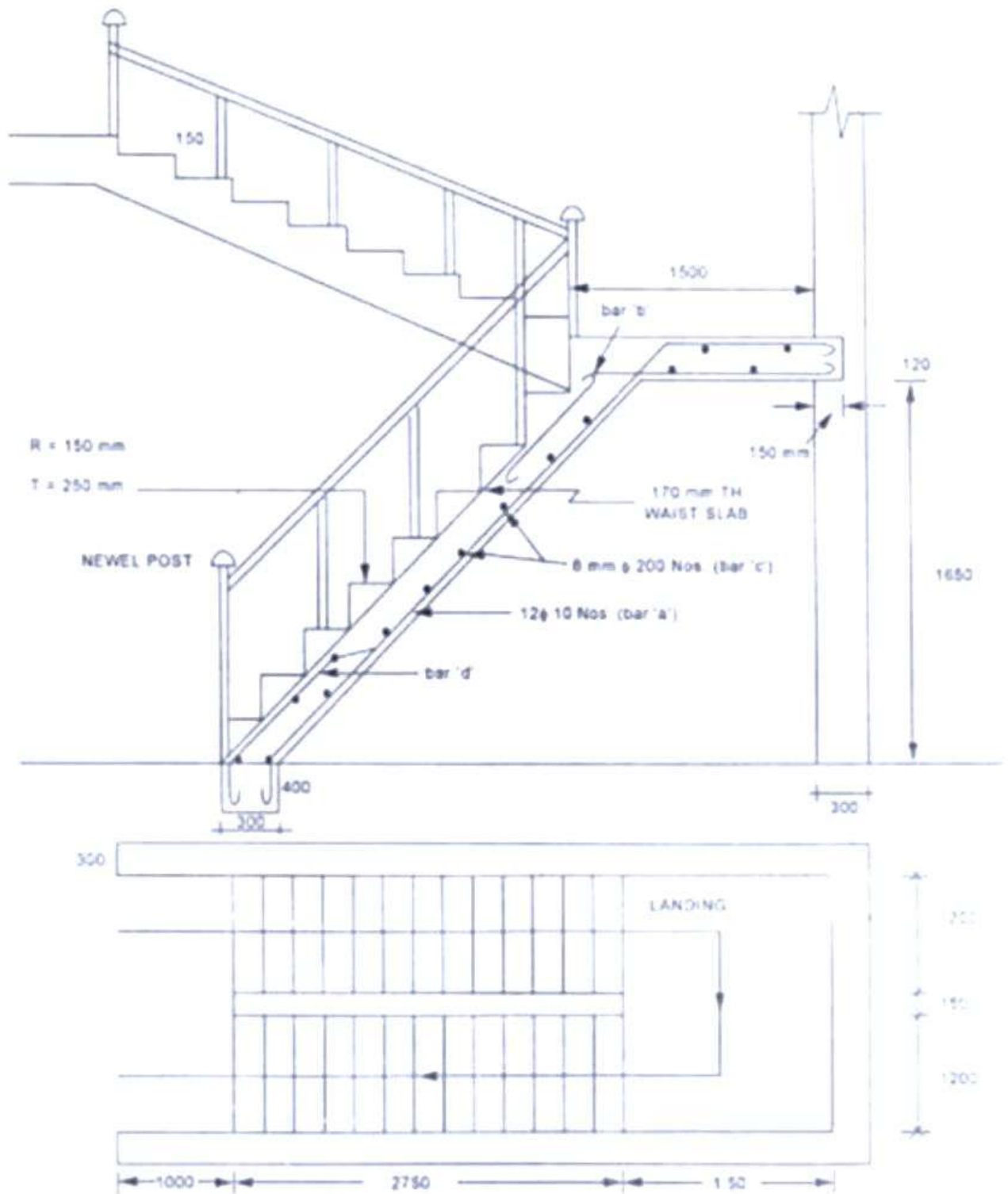

Fig. 4.12

## R.C.C. Stair Case

S.No.	Particulars of Items	No.	L	B	H	Q	Explanation
1	R.C.C. (1:2:4) excluding steel and its fabrication but including centering and shuttering and binding wire.						
	a) Toe wall	1x1	3.15	0.3	0.4	0.38	m <sup>3</sup> L=(1.2+0.15+1.2+2x0.3)
	b) Waist slab for I and II flights	1x2	3.21	1.2	0.17	1.31	L = $\sqrt{2.75^2 + 1.65^2} = 3.21m$
	c) Landing Middle and first floor	1x2	2.85	1.65	0.17	1.60	L=(1.2+0.15+1.2+2x0.15)
					Total	3.29	m <sup>3</sup>
2.	1st class brick work in C.M. (1:4) for steps	2x11	1.2	$\frac{1}{2}x(0.25+1.5)$		0.495	
3.	20mm thick cement plastering (1:5) for steps finished neat						
	a) Treads & Rises	2x11	1.2	$x(0.25+0.15)$		10.56	
	b) ends of steps	2x11		$\frac{1}{2}x(0.25+1.5)$		0.41	
					Total	10.97	m <sup>2</sup>
4.	2.5cm No sing in steps	2x12	1.2	--	--	28.8	RM
5.	2.5cm C.C. flooring finished neat cement floating in middle and first floor landing	1x2	2.55	1.2	--	6.12	m <sup>2</sup>
6.	Supplying and fixing of best teak wood hand rail finished smooth	1x1	6.67	--	--	6.67	RM
7.	supply and fixing of best teak wood newel posts & finished smooth	1x2	1.0	0.1	0.1	0.02	m <sup>3</sup>
8.	Cap of Newel post	1x2	---	--	---	2Nos.	

---

### **3.1 GENERAL OR BRIEF SPECIFICATION:**

This gives the nature and class of the work and materials in general terms, to be used in the various parts of work, from the foundation to the superstructure. It is a short description of different parts of work specifying materials, proportions, qualities, etc., General specifications give general idea of the whole work or structure and are useful for preparing for estimate

### **3.2 DETAILED SPECIFICATIONS**

#### **3.2.1 DETAILED SPECIFICATIONS OF EXCAVATIONS, FILLING AND BACKFILLING**

##### **Scope of Work**

The scope for work covered under this specifications pertain to excavation of foundations, trenches, pits and over areas, in all sorts of soil, soft and hard rock, correct to dimensions given in the drawing including shoring, protections of existing underground utilities of any, such as water lines, electric cables etc. dewatering and shoring if necessary, stacking the useful materials as directed within the lead specified, refilling around the foundation and into the plinth with selected useful excavated earth and disposing off the surplus earth / materials within specified lead and finishing the surface to proper levels, slopes and camber etc. all complete.

##### **Site Clearance:**

Before the earth work is started the area coming under cutting and filling shall be cleared of all obstruction, loose stones, shrubs, rank vegetation, grass, bushes and rubbish removed up to a distance of 150 metres outside the periphery of the area under clearance. This work is deemed to be included in the earthwork item rate and no separate payment will be admissible.

**Lead and Lift:**

**Lead:** The lead for disposal / deposition of excavated materials shall be as specified in the respective item of work. For the purpose of measurements of lead, the area to be excavated or filled or area on

---

---

---

which excavated material is to be deposited/ disposed off shall be divided in suitable blocks and for each of the block, the distance between center lines shall be taken as the leads which shall be measured by the shortest straight line route on the plan and not the actual route adopted.

**Lift:** Lift shall be measured from ground level. Excavation up to 1.5m depth below ground level and depositing excavated material on the ground shall be included in the item of earthwork for various kinds of soil. Extra lift shall be measured in unit of 1.5m or part thereof. Obvious lift shall only be measured that is lifts inherent in the lead due to ground slope shall not be measured, except for lead up to 250m. All excavation shall be measured in successive stages of 1.5m stating the commencing level. This shall not apply to cases where no lift is involved as in hill side cutting.

## **OBJECTS OF VALUATION**

### **DEFINITIONS**

Market Value

Book Value

Capital cost

Sinking Fund Method

Direct comparison with the capital Value

Depreciation Method of Valuation

Methods for calculating depreciation

### **FIXATION OF RENT**

### **CALCULATION OF STANDARD RENT OF A GOVT. PROPERTY**

#### **TECHNICAL TERMS**

#### **1. EXPENDITURE**

The whole amount can be spent during the financial year or not.

#### **2. CAPITAL COST**

Total cost including all the expenditure incurred from beginning to the completion of a work.

#### **3. PROVISIONAL SUM**

Estimate of bill quantities for some special work to be done by a specialist firm whose details are known at the time of preparation of estimate.

#### **4. RATE OF COST**

The cost per unit of subhead which is arrived at by dividing the up-to-date final charges on a sub-head by its up-to-date progress.



## **5. PREMIUM**

The tendered percentage rate above the notified rates.

## **6. REBATE**

The tendered percentage rate below the notified rates.

## **7. PLINTH AREA**

It is a covered area of a building measured at floor level. It is measured by taking external dimensions excluding plinth offset if any.

## **8. RATES**

Rates followed are of sanctioned schedule of rates or nonscheduled, this fact is to be mentioned under this sub – head.

## **9. CONTINGENCIES**

Incidental expenses of miscellaneous character which cannot be classified approximately under any distinct sub-head, but is added in the cost of construction necessarily.

## **10. VALUATION**

Valuation is the technique of estimating or determining the fair price or value of a property such as building, a factory, other engineering structure of various types, land...etc.

## **12. SALVAGE VALUE**

It is the value of end of utility period without being dismantled.

## **SINKING FUND**

The fund is gradually accumulated by way of periodic on annual deposit for the replacement of the building or structure at the end of its useful life.

## **DEPRECIATION**

Depreciation is the gradual exhaustion of a usefulness of a property. Decrease or loss in the value of a property due to its structural deterioration use, life wear and tear, decay and obsolescence.

## **SCRAP VALUE**

Scrap value is the value of dismantled materials. For a building when the life is over the end of utility period of dismantled materials as steel, bricks, timber. Etc. will fetch certain amount which is scrap value of a building.

## **5.1 OBJECTS OF VALUATION**

It is the technique of estimating and determining the fair price or value of a property such as a building, a factory or other engineering structures of various types, land etc.

### **5.1.1 Six important Purposes of Valuation:**

The main purposes of valuation are as follows:

#### **Buying or Selling Property**

When it is required to buy or sell a property, its valuation is required.

#### **Taxation**

To assess the tax of a property, its valuation is required. Taxes may be municipal tax, wealth tax, Property tax etc, and all the taxes are fixed on the valuation of the property.

#### **Rent Function**

In order to determine the rent of a property, valuation is required. Rent is usually fixed on the certain percentage of the amount of valuation which is 6% to 10% of valuation.

### **Valuation of Building:**

Valuation of a building depends on the type of the building, its structure and durability, on situation, size, shape, frontage, width of roadways, the quality of materials used in the construct and present day prices of materials. Valuation also depends on the height of the building, height of plinth, thickness of the wall, nature of the floor, roof, doors, windows etc.

The valuation of a building is determined on working out its cost of construction at pres day rate and allowing a suitable depreciation.

### **Six Methods of Valuation**

1. Rental Method of Valuation
2. Direct Comparisons of the capital value
3. Valuation based on the profit
4. Valuation based on the cost
5. Development method of Valuation
6. Depreciation method of Valuation

### a) **Market Value**

The market value of a property is the amount which can be obtained at any particular time from the open market if the property is put for sale. The market value will differ from time to time according to demand and supply.

The market value also changes from time to time for various miscellaneous reasons such as changes in industry, changes in fashions, means of transport, cost of materials and labour etc.

### b) **Book Value**

Book value is the amount shown in the account book after allowing necessary depreciations. The book value of a property at a particular year is the original cost minus the amount of depreciation allowed per year and will be gradually reduced year to year and at the end of the utility period of the property, the book value will be only scrap value.

### c) **Capital cost**

Capital cost is the total cost of construction including land, or the original total amount required to possess a property. It is the original cost and does not change while the value of the property is the present cost which may be calculated by methods of Valuation.

### **Capitalized Value of a Property**

The capitalized value of a property is the amount of money whose annual interest at the highest prevailing rate of interest will be equal to the net income from the property. To determine the capitalized value of a property, it is required to know the net income from the property and the highest prevailing rate of interest.

Therefore, Capitalized Value = Net income x year's purchase

### **Year's Purchase**

Year's purchase is defined as the capital sum required to be invested in order to receive a net receive a net annual income as an annuity of rupee one at a fixed rate of interest.

The capital sum should be  $1 \times 100 / \text{rate of interest}$ .

#### 5.2.4 Sinking Fund Method

In this method, the depreciation of a property is assumed to be equal to the annual sinking fund plus the interest on the fund for that year, which is supposed to be invested on interest bearing investment. If  $A$  is the annual sinking fund and  $b, c, d, \dots$  represent subsequent years and  $C =$  total original cost, then –

106 / 110 func

## **Rental Method of Valuation**

In this method, the net income by way of rent is found out by deducting all outgoing from the gross rent. A suitable rate of interest as prevailing in the market is assumed and Year's purchase is calculated. This net income multiplied by Year's Purchase gives the capitalized value or valuation of the property. This method is applicable only when the rent is known or probable rent is determined by enquiries.

### **5.2.5 Direct comparison with the capital Value**

This method may be adopted when the rental value is not available from the property concerned, but there are evidences of sale price of properties as a whole. In such cases, the capitalized value of the property is fixed by direct comparison with capitalized value of similar property in the locality.

### **Valuation based on profit**

This method of Valuation is suitable for buildings like hotels, cinemas, theatres etc for which the capitalized value depends on the profit. In such cases, the net income is worked out after deducting gross income; all possible working expense, outgoings, interest on the capital invested etc. The net

89

---

---

---

profit is multiplied by Year's Purchase to get the capitalized value. In such cases, the valuation may work out to be high in comparison with the cost of construction.

### **Valuation based on cost**

In this method, the actual cost incurred in constructing the building or in possessing the property is taken as basis to determine the value of property. In such cases, necessary depreciation should be allowed and the points of obsolescence should also be considered.

107 / 110

### **Development Method of Valuation**

This method of Valuation is used for the properties which are in the underdeveloped stage or partly developed and partly underdeveloped stage. If a large place of land is required to be divided into plots after providing for roads, parks etc, this method of valuation is to be adopted. In such cases, the probable selling price of the divided plots, the area required for roads, parks etc and other expenditures for development should be known.

If a building is required to be renovated by making additional changes, alterations or improvements, the development method of Valuation may be used.

#### **5.2.6 Depreciation Method of Valuation**

According to this method of Valuation, the building should be divided into four parts:

1. Walls
2. Roofs
3. Floors
4. Doors and Windows

And the cost of each part should first be worked out on the present day rates by detailed measurements.

The present value of land and water supply, electric and sanitary fittings etc should be added to the valuation of the building to arrive at total valuation of the property.

90

---

---

---

Depreciation is the gradual exhaustion of the usefulness of a property. This may be defined as the decrease or loss in the value of a property due to structural deterioration, life wear and tear, decay and obsolescence.

#### **5.2.6.1 Methods for calculating depreciation**

1. Straight line Method
2. Constant percentage method
3. Sinking Fund Method
4. Quantity Survey Method

108 / 110

## **Straight Line Method**

In this method, it is assumed that the property loses its value by the same amount every year. A fixed amount of the original cost is deducted every year, so that at the end of the utility period, only the scrap value is left.

*Annual Depreciation,  $D = (\text{original cost of the asset} - \text{Scrap Value})/\text{life in years}$*

For example, a vehicle that depreciates over 5 years, is purchased at a cost of **US\$17,000**, and will have a salvage value of **US\$2,000**, will depreciate at **US\$3,000** per year:  $(\$17,000 - \$2,000) / 5 \text{ years} = \$3,000$  annual straight-line **depreciation expense**. In other words, it is the **depreciable cost** of the asset divided by the number of years of its useful life.

## **Constant Percentage Method or Declining balance Method**

In this method, it is assumed that the property will lose its value by a constant percentage of its value at the beginning of every year.

*Annual Depreciation,  $D = 1 - (\text{scrap value}/\text{original value})^{1/\text{life in year}}$*



## **Quantity Survey Method**

In this method, the property is studied in detail and loss in value due to life, wear and tear, decay, and obsolescence etc, worked out. Each and every step is based on some logical grounds without any fixed percentage of the cost of the property. Only experimental valuer can work out the amount of depreciation and present value of a property by this method.

### **5.3 FIXATION OF RENT**

Capitalized value of the property can be known by any of the methods discussed earlier and suitable value of year's purchase is adopted according to the admissible rate of interest (8% or any other fair rate).

Then, Net income = capitalized value / year's purchase

All possible outgoings are added to this net income which will give gross income from the property.  
Gross income or gross rent = Net rent + outgoings

The standard rent = (Gross Income / 12) per month.

## RATE ANALYSIS OF PLASTER WORK

- Prepare Rate Analysis for a plastering work in Cement-Mortar (1:6). Thickness of plaster is 12mm & Area of Wall is 100m<sup>2</sup>.

S.No	DESCRIPTION	UNIT	QUANTITY	RATE	AMOUNT
<b>A- MATERIAL COST</b>					
1.	CEMENT	BAG	6.56	Rs. 400/Bag	2624.00
2.	SAND	CUM	1.37	Rs. 1200/cum	1644.00
					4268.00
<b>B- LABOUR COST</b>					
1.	MASON	DAY	4.00	Rs. 550/day	2200.00
2.	MAZDOOR	DAY	6.0	Rs. 400/day	2400.00
3.	BELDAR	DAY	4.0	Rs. 350/day	1400.00
4.	BHISTI	DAY	2.0	Rs. 300/day	600.00
	SCAFOLDING	Lump sum	—	Rs. 550	550.00
					7150.00

$$\begin{array}{c} \uparrow \quad \uparrow \\ \text{Ratio of plaster} = 1:6 \end{array}$$

$$\text{Thickness of plaster} = 12 \text{ mm}$$

$$\begin{aligned} \text{Volume of plaster} &= \text{Area} \times \text{Thickness} \\ &= 100 \times 0.012 \\ &= 1.2 \text{ m}^3 \end{aligned}$$

$$\begin{aligned} \text{Dry Volume of plaster} &= 1.33 \times \text{Wet Volume} \\ &= 1.33 \times 1.2 \\ &= 1.6 \text{ m}^3 \end{aligned}$$

$$\text{Sum of Ratio for plaster} = 1 + 6 = 7$$

$$\begin{aligned} \text{Quantity of Cement} &= \frac{\text{Ratio of Cement}}{\text{Sum of Ratio}} \times \text{Dry Volume} \\ &= \frac{1}{7} \times 1.6 = 0.228 \text{ m}^3 \end{aligned}$$

$$\text{Weight of Cement} = 0.228 \times 1440 = 328.32 \text{ kg} \quad \left[ \text{Density of Cement} \right]$$

$$\text{Number of Bags} = \frac{328.32}{50} = 6.56 \text{ Bags}$$

$$\bullet \text{ Quantity of Cement} = \frac{\text{Ratio of Cement}}{\text{Sum of Ratio}} \times \text{Dry Volume}$$

$$= \frac{1}{7} \times 1.6 = 0.228 \text{ m}^3$$

$$\text{Weight of Cement} = 0.228 \times 1440 = 328.32 \text{ kg} \quad \left[ \text{Density of Cement} = 1440 \text{ kg/m}^3 \right]$$

$$\text{Number of Bags} = \frac{328.32}{50} = 6.56 \text{ Bags} \quad \left[ 1 \text{ Bag of Cement} = 50 \text{ kg} \right]$$

$$\bullet \text{ Quantity of Sand} = \frac{\text{Ratio of Sand}}{\text{Sum of Ratio}} \times \text{Dry Volume}$$

$$= \frac{6}{7} \times 1.6 = 1.37 \text{ m}^3$$

Q. Prepare Rate analysis for a PCC work (1:3:6).

Sol<sup>n</sup>:-

**Given:** - Concrete grade = M<sub>10</sub> (1:3:6)

**Take = 10m<sup>3</sup> volume for PCC**

Add 52% extra for voids to get dry vol<sup>m</sup>. Of Concrete.

$$\begin{aligned}\text{Volume of dry concrete} &= 1.52 \times 10 \\ &= 15.2 \text{ m}^3\end{aligned}$$

$$\begin{aligned}\text{Quantity of cement} &= \left( \frac{15.2}{1+3+6} \right) \times 1 \\ &= 1.52 \text{ m}^3\end{aligned}$$

Quantity of cement = 1.52 m<sup>3</sup>

**Take = 10m<sup>3</sup> volume for PCC**

Add 52% extra for voids to get dry vol<sup>m</sup>. Of Concrete.

**Volume of dry concrete = 1.52 × 10**

$$= 15.2 \text{ m}^3$$

**Quantity of cement =  $\left(\frac{15.2}{1+3+6}\right) \times 1$**

$$= 1.52 \text{ m}^3$$

No. of bags = 1.52 × 28.5

$$= 43.32 \text{ bags} \cong 44 \text{ bags (say)}$$

**Take = 10m<sup>3</sup> volume for PCC**

Add 52% extra for voids to get dry vol<sup>m</sup>. Of Concrete.

$$\begin{aligned}\text{Volume of dry concrete} &= 1.52 \times 10 \\ &= 15.2 \text{ m}^3\end{aligned}$$

$$\begin{aligned}\text{Quantity of cement} &= \left(\frac{15.2}{1+3+6}\right) \times 1 \\ &= 1.52 \text{ m}^3\end{aligned}$$

$$\begin{aligned}\text{No. of bags} &= 1.52 \times 28.5 \\ &= 43.32 \text{ bags} \cong 44 \text{ bags (say)}\end{aligned}$$

$$\begin{aligned}\text{Quantity of sand} &= \left(\frac{15.2}{1+3+6}\right) \times 3 \\ &= 4.56 \text{ m}^3\end{aligned}$$

$$\begin{aligned}\text{NO. OF BAGS} &= 1.52 \times 28.5 \\ &= 43.32 \text{ bags} \cong 44 \text{ bags (say)}\end{aligned}$$

$$\begin{aligned}\text{Quantity of sand} &= \left(\frac{15.2}{1+3+6}\right) \times 3 \\ &= 4.56 \text{ m}^3\end{aligned}$$

$$\begin{aligned}\text{Quantity of aggregate} &= \left(\frac{15.2}{1+3+6}\right) \times 6 \\ &= 9.12 \text{ m}^3\end{aligned}$$



Sr. No.	Material	Unit	Quantity	Rate	Amount	
					₹	P.
1.	Cement	Bags	44	350/-	15400	00
2.	Sand	m <sup>3</sup>	4.56	1000/-	4560	00
3.	Aggregate	m <sup>3</sup>	9.12	1200/-	10944	00
<b>Total Amount = ₹ 30904.00/-</b>						

### C. Cost of labours

Sr. No.	Labour	Men (nos.)	Rate	Per(Day)	Amount	
					₹	P.
1.	Head Mason	½	400/-	Day	200	00
2.	Mason	1½	350/-	Day	525	00
3.	Male Mazdoor	12	200/-	Day	2400	00
4.	Coolie	18	150/-	Day	2700	00
5.	Bhisti	3	250/-	Day	750	00
6.	T&P	Lump sum	100/-	—	100	00
<b>Total Amount = ₹ 6675.00/-</b>						

$$= 30904.00 + 6675.00$$

Total cost = ₹ 37579.00/-

**Add 1.5% Water Charges of total cost**

$$= \left(\frac{1.5}{100}\right) \times 37579$$

Water charges = ₹ 563.69/- (say = ₹ 564.00/-)

**Add 10% Contractor's Charges =  $\left(\frac{10}{100}\right) \times 37579$**

**Contractor's Charges = ₹ 3758.90/- (say = ₹ 3759.00/-)**

**Q.** Prepare Rate analysis for a Brick work in cement-mortar (1:4).

**Sol<sup>n</sup>:-**

**Given:** - Take volume =  $10\text{m}^3$

**W.K.T. No. of Bricks @ 500 per  $\text{m}^3$**

$$\begin{aligned}\text{No. of Bricks} &= 500 \times 10 \\ &= 5000 \text{ nos.}\end{aligned}$$

**Volume of dry mortar = 30% of Vol<sup>m</sup>.**

$$\begin{aligned}&= \frac{30}{100} \times 10 \\ &= 3 \text{ m}^3\end{aligned}$$

---

$$\text{Quantity of cement} = \left(\frac{3}{1+4}\right) \times 1$$

$$= 0.60 \text{ m}^3$$

$$\text{No. of bags} = 0.60 \times 28.5$$

$$= 17.10 \text{ bags} \cong 18 \text{ bags (say)}$$

$$\text{Quantity of sand} = \left(\frac{3}{1+4}\right) \times 4$$

$$= 2.40 \text{ m}^3$$

### B. Cost of materials

Sr. No.	Material	Unit	Quantity	Rate	Amount	
					₹	P.
1.	Cement	Bags	18	350/-	6300	00
2.	Sand	m <sup>3</sup>	2.40	1000/-	2400	00
3.	Bricks	Nos.	5000	4/-	20000	00

**Total Amount = ₹ 28700.00/-**

### C. Cost of labours

Sr. No.	Labour	Men (nos.)	Rate	Per(Day)	Amount	
					₹	P.
1.	Head Mason	1	400/-	Day	400	00
2.	Mason	8	350/-	Day	2800	00
3.	Male Mazdoor	6	200/-	Day	1200	00
4.	Coolie	6	150/-	Day	900	00
5.	Bhisti	1	250/-	Day	250	00
6.	T&P	Lump sum	100/-	—	100	00
7.	Scaffolding	Lump sum	250/-	—	250	00

**Total Amount = ₹ 5900.00/-**

$$\begin{aligned}\text{Total cost} &= \text{Cost of materials} + \text{Cost of labours} \\ &= 28700.00 + 5900.00\end{aligned}$$

$$\text{Total cost} = ₹ 34600.00/-$$

$$\begin{aligned}\text{Add 1.5\% Water Charges of total cost} \\ &= \left(\frac{1.5}{100}\right) \times 34600\end{aligned}$$

$$\text{Water charges} = ₹ 519.00/-$$



**Add 10% Contractor's Charges =  $(\frac{10}{100}) \times 34600$**

**Contractor's Charges = ₹ 3460.00/-**

---

**Grand total = 34600.00+519.00+3460.00**

**= ₹ 38579.00/-**

**Rate of work per m<sup>3</sup> =  $\frac{38579}{10} \Rightarrow ₹ 3857.90/-$**

**Hence Rate of Brick work per m<sup>3</sup> is ₹ 3858.00/-**

---