

## syllabus

### 1 Introduction

- 1.1 Importance of Highway transportation: importance organizations like Indian roads congress, Ministry of Surface Transport, Central Road Research Institute.
- 1.2 Functions of Indian Roads Congress
- 1.3 IRC classification of roads
- 1.4 Organisation of state highway department

### 2 Road Geometrics

- 2.1 Glossary of terms used in geometric and their importance, right of way, formation width, road margin, road shoulder, carriage way, side slopes, kerbs, formation level, camber and gradient
- 2.2 Design and average running speed, stopping and passing sight distance
- 2.3 Necessity of curves, horizontal and vertical curves including transition curves and super elevation, Methods of providing super – elevation

### 3 Road Materials

- 3.1 Difference types of road materials in use: soil, aggregates, and binders
- 3.2 Function of soil as highway Subgrade
- 3.3 California Bearing Ratio: methods of finding CBR valued in the laboratory and at site and their significance
- 3.4 Testing aggregates: Abrasion test, impact test, crushing strength test, water absorption test & soundness test

### 4 Road Pavements

- 4.1 Road Pavement: Flexible and rigid pavement, their merits and demerits, typical cross-sections, functions of various components  
Flexible pavements:
- 4.2 Sub-grade preparation:  
Setting out alignment of road, setting out bench marks, control pegs for embankment and cutting, borrow pits, making profile of embankment, construction of embankment, compaction, stabilization, preparation of subgrade, methods of checking camber, gradient and alignment as per recommendations of IRC, equipment used for subgrade preparation
- 4.3 Sub base Course:  
Necessity of sub base, stabilized sub base, purpose of stabilization (no designs)  
Types of stabilization
  - Mechanical stabilization
  - Lime stabilization
  - Cement stabilization
  - Fly ash stabilization
- 4.4 Base Course:  
Preparation of base course, Brick soling, stone soling and metalling, Water Bound Macadam and wet-mix Macadam, Bituminous constructions: Different types
- 4.5 Surfacing:
  - Surface dressing
  - (i) Premix carpet and (ii) Semi dense carpet
    - Bituminous concrete
    - Grouting
- 4.6 Rigid Pavements:  
Concept of concrete roads as per IRC specifications

### 5 Hill Roads:

- 5.1 Introduction: Typical cross-sections showing all details of a typical hill road in cut, partly in cutting and partly in filling
- 5.2 Breast Walls, Retaining walls, different types of bends

**6 Road Drainage:**

6.1 Necessity of road drainage work, cross drainage works

6.2 Surface and sub-surface drains and storm water drains. Location, spacing and typical details of side drains, side ditches for surface drainage, intercepting drains, pipe drains in hill roads, details of drains in cutting embankment, typical cross sections.

**7 Road Maintenance :**

7.1 Common types of road failures – their causes and remedies

7.2 Maintenance of bituminous road such as patch work and resurfacing

7.3 Maintenance of concrete roads – filling cracks, repairing joints, maintenance of shoulders (berm), maintenance of traffic control devices

7.4 Basic concept of traffic study, Traffic safety and traffic control signal

**8 Construction equipments:**

Preliminary ideas of the following plant and equipment:

8.1 Hot mixing plant

8.2 Tipper, tractors (wheel and crawler) scraper, bulldozer, dumpers, shovels, graders, roller dragline

8.3 Asphalt mixer and tar boilers

8.4 Road pavers

8.5 Modern construction equipments for roads.

## INTRODUCTION

**Importance of Highway transportation: importance organizations like Indian roads congress, Ministry of Surface Transport, Central Road Research Institute.**

**Importance of Highway transportation:**

Highway transportation is the means of detail distribution between homes, shops, factories, etc. It is only the roads which can carry goods from and to aerodromes, harbours and railway stations. Considering the utility of roads anywhere in the different parts of a country, they can be rightly compared to arteries in a human body just as arteries maintain man's health by providing circulation of blood; similarly roads promote nation's wealth by keeping its people and goods moving. Thus, we see that progress and well-being of a nation depends much on roads. In fact, roads are the life lines of nation's economy.

The importance or necessity of highway transportation can be easily judged from the following purposes or advantages of roads:-

They facilitate conveyance of people, goods, raw-materials, manufactured articles, etc. speedily and easily in the different parts of a country.

1. They act as the only source of communication in regions of high altitude *i.e* in mountainous regions.
2. They help in growth of trade and other economy activities in and outside the villages and towns by establishing contact between towns and villages.
3. They help in providing efficient distribution of agricultural products and natural resources all over the country.
4. They help in price stabilization of commodities due to mobility of products all over the country.
5. They help in social and cultural advancement of people and making the villagers active and alert members of the community.
6. They help in promoting the cultural and social ties among people living in different part of a country and thus strengthen the national unity.
7. They help in providing improved medical facilities quickly to human beings, especially to those who live in rural areas.
8. They provide more employment opportunities.
9. They enhance land value and thus bring better revenue.
10. They serve as feeders for Airways, Waterways and Railways.
11. They help in reducing distress among the people, caused due to famine, by supplying them food and clothing quickly.

Lastly, it can be sad that roads are the symbol of country's progress and thus development made by any country can be judged by the quality and network of it's road system.

### **Indian roads congress:**

Indian Roads Congress (IRC) was set up by the Government of India in December, 1934 on the recommendations of Jayakar Committee with the objective of promoting and encouraging the science for building and maintenance of roads. It also provides a national forum for sharing of knowledge and pooling of experience on the entire range of subjects dealing with the construction and maintenance of roads and bridges. IRC has now about 13,500 members comprising of engineers of all ranks from Central and State Governments, Engineering Services of Army, Border Roads Organization, Road Research Institutes, Engineering Colleges, Local Bodies and private enterprises.

#### **Functions of Indian Roads Congress(IRC) :**

IRC a body of professional highway engineers provides the following services:

- I. It provides a forum for expression of collective opinion of its members for all matters affecting the construction and maintenance of roads in India.
- II. It promotes the use of the standard specifications and practices.
- III. It provided with the suggestions for the better methods of planning, designing, construction, administration and maintenance of roads.
- IV. It conducts periodical meetings to discuss technical problems regarding roads.
- V. It makes the laws for the development, improvement and protection of the roads.
- VI. It furnishes and maintains libraries and museums for encouraging the science of road making.

#### **Functions of Central Road Research Institute (CRRI):**

CRRI was started by the Central Government in 1950, for the research work in the highway engineering. CRRI is a series of laboratories under the council of scientific and industrial research in India. It offers the following services:

1. Carries basic and applied research for the design, construction and maintenance of the highways.
2. Carries research on traffic safety and transport economics.
3. Carries research on economical utilization of locally available materials for construction and maintenance of roads.
4. Research for the development of the new machinery, tools equipment and instruments for highway engineering.
5. To provide technical advice and consultancy services to various organizations.
6. To provide library and documentation services.

#### **Ministry of Surface Transport**

The **Ministry of Road Transport and Highways** is a ministry of the Government of India, that is the apex body for formulation and administration of the rules, regulations and laws relating to road transport,

transport research and in also to increase the mobility and efficiency of the road transport system in India. Through its officers of Central Engineering Services (Roads) cadre it is responsible for the development of National Highways of the country. Road transport is a critical infrastructure for economic development of the country. It influences the pace, structure and pattern of development. In India, roads are used to transport over 60 percent of the total goods and 85 percent of the passenger traffic. Hence, development of this sector is of paramount importance for India and accounts for a significant part in the budget.

**Roads wing of ministry of surface transport:**

The roads wing of the ministry of Surface Transport handles the road matters of the Central Govt. It is headed by a Director General.

The Director General is assisted by two additional Director Generals(one for roads and one for bridges), a numbers of Chief Engineers, Superintending Engineers, Executive Engineers and Asst. Executive Engineers. The roads wing has a chief Engineer for the North-East region posted at Guwahati and a Liaison-cum-Inspectorate organization consisting of S.E's and E.E's in the various states. The functions of the roads wing of Surface Transport are:

- a. To control funds approved by Central Government for the development of National Highways.
- b. To control the central road fund.
- c. To prepare plans for development and maintenance of National Highways in consultation with state PWD's.
- d. To oversee technically the quality of works executed by the agencies.
- e. To administer matters regarding road research.
- f. To examine technically the projects of roads and bridges prepared by the PWD's.
- g. To administer the central road program other than National Highways in the Union Territories.

**IRC classification of roads :**

**IRC(Indian Roads Congress)** has classified the roads in the India in the following 5 categories:

- (a) National Highways
- (b) State Highways
- (c) Major District Roads
- (d) Other District Roads
- (e) Village Roads

**National Highways(NH):** National highways are the major arterial roads spanning in the length and breadth of the country and connects the Capital to the various state capitals of the country or with the neighbouring countries.

They also connect the famous tourism places of the country. National highways are numbered and written as NH-1, NH-2 etc. They have the highest design specifications.



*Example :* NH -1 Delhi-Ambala-Amritsar, NH-21 Chandigarh- Mandi- Manali.

**State Highways(SH):** State highways are the roads which connect the state capital to other states and to the district headquarters in the state. They have design specifications similar to those of the National Highways because they carry enough traffic.

**Major District Roads(MDR):** These roads connect the district headquarters to the main town centres in the district, and to the headquarters of the other districts also. They also connect these major town centres to the other state highways of importance. They have lower design specifications as compared to the NH and SH.

**Other district roads(ODR):** These roads connect the rural areas town centres to the major district roads of higher importance. They provide the facilities for the transportation of the raw materials or the goods mainly of agricultural products from the rural towns to the higher markets and vice-versa.

**Village Roads (VR):** These roads connect the rural villages with one another and to the nearest higher level road or to the nearest town centre. They have lower design specifications and many of them are not even metalled.

### **Organisation of state highway department**

Responsibility for new construction and maintenance works on the National Highways is under the control of the Chief Engineer National Highways (CE (NH)). The CE (NH) reports to MOST for works carried out on the National Highway network.

This wing has been set up in keeping with the requirements of MOST to:

- reduce the line of communication between the GOI and State Authorities
- achieve efficiencies in implementation by avoiding the cumbersome and outdated delegations for administrative and technical sanction which limit the ability of the Odisha Works Department to respond quickly

- achieve uniform maintenance and construction standards on NHs.

At present, 16 Nos. of National Highways measuring 3592.932 km in length traversed through the state of Odisha. Out of 3592.932 km of total length of National Highways in Odisha, 3071.722 km is under the control of NH wing of State PWD, and remaining 521.210 km have been transferred to National Highways Authority of India for improvement under NHDP and Port connectivity.

## **ROAD GEOMETRICS**

**Glossary of terms used in geometric and their importance, right of way, formation width, road margin, road shoulder, carriage way, side slopes, kerbs, formation level, camber and gradient**

### **Right of way**

Right of way (ROW) or land width is the width of land acquired for the road, along its alignment. It should be adequate to accommodate all the cross-sectional elements of the highway and may reasonably provide for future development. To prevent ribbon development along highways, control lines and building lines may be provided. Control line is a line which represents the nearest limits of future uncontrolled building activity in relation to a road. Building line represents a line on either side of the road, between which and the road no building activity is permitted at all. The right of way width is governed by:

1. Width of formation: It depends on the category of the highway and width of roadway and road margins.
2. Height of embankment or depth of cutting: It is governed by the topography and the vertical alignment.
3. Side slopes of embankment or cutting: It depends on the height of the slope, soil type etc.
4. Drainage system and their size which depends on rainfall, topography etc.
5. Sight distance considerations : On curves etc. there is restriction to the visibility on the inner side of the curve due to the presence of some obstructions like building structures etc.
6. Reserve land for future widening: Some land has to be acquired in advance anticipating future developments like widening of the road.

**Table :** Normal right of way for open areas

Road classification	Roadway width in m	
	Plain and rolling terrain	Mountainous and steep terrain
Open areas		
NH/SH	45	24
MDR	25	18
ODR	15	15
VR	12	9
Built-up areas		
NH/SH	30	20
MDR	20	15
ODR	15	12
VR	10	9

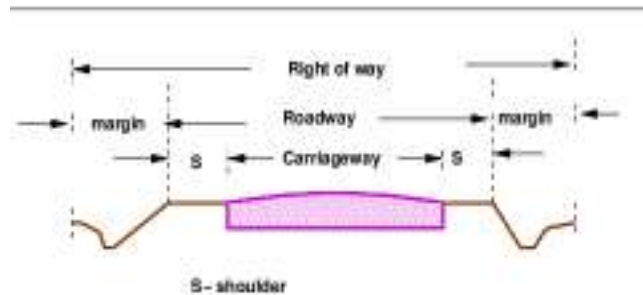
**Figure :** A typical Right of way (ROW)

The importance of reserved land is emphasized by the following. Extra width of land is available for the construction of roadside facilities. Land acquisition is not possible later, because the land may be occupied for various other purposes (buildings, business etc.) The normal ROW requirements for built up and open areas as specified by IRC is given in the above Table A typical cross section of a ROW is given in above Figure .

### Factors Affecting Right of Way

- Width of formation
- Height of embankment
- Side slopes
- Drainage system
- Sight distances consideration on horizontal curves
- Future extension

### Formation width

Width of formation or roadway width is the sum of the widths of pavements or carriage way including separators and shoulders. This does not include the extra land in formation/cutting. The values suggested by IRC are given in Table



**Table :** Width of formation for various classed of roads

Road classification	Roadway width in m	
	Plain and rolling terrain	Mountainous and steep terrain
NH/SH	12	6.25-8.8
MDR	9	4.75
ODR	7.5-9.0	4.75
VR	7.5	4.0

**Road margin**

The portion of the road beyond the carriageway and on the roadway can be generally called road margin. Various elements that form the road margins are given below.

**1. Shoulders**

Shoulders are provided along the road edge and is intended for accommodation of stopped vehicles, serve as an emergency lane for vehicles and provide lateral support for base and surface courses. The shoulder should be strong enough to bear the weight of a fully loaded truck even in wet conditions. The shoulder width should be adequate for giving working space around a stopped vehicle. It is desirable to have a width of 4.6 m for the shoulders. A minimum width of 2.5 m is recommended for 2-lane rural highways in India.

**2. Parking lanes**

Parking lanes are provided in urban lanes for side parking. Parallel parking is preferred because it is safe for the vehicles moving on the road. The parking lane should have a minimum of 3.0 m width in the case of parallel parking.

**3. Bus-bays**

Bus bays are provided by recessing the kerbs for bus stops. They are provided so that they do not obstruct the movement of vehicles in the carriage way. They should be at least 75 meters away from the intersection so that the traffic near the intersections is not affected by the bus-bay.

**4. Service roads**

Service roads or frontage roads give access to access controlled highways like freeways and expressways. They run parallel to the highway and will be usually isolated by a separator and access to the highway will be provided only at selected points. These roads are provided to avoid congestion in the expressways and also the speed of the traffic in those lanes is not reduced.

**5. Cycle track**

Cycle tracks are provided in urban areas when the volume of cycle traffic is high. Minimum width of 2 meter is required, which may be increased by 1 meter for every additional track.

## 6 .Footpath

Footpaths are exclusive right of way to pedestrians, especially in urban areas. They are provided for the safety of the pedestrians when both the pedestrian traffic and vehicular traffic is high. Minimum width is 1.5 meter and may be increased based on the traffic. The footpath should be either as smooth as the pavement or more smoother than that to induce the pedestrian to use the footpath.

## 7 .Guard rails

They are provided at the edge of the shoulder usually when the road is on an embankment. They serve to prevent the vehicles from running off the embankment, especially when the height of the fill exceeds 3 m. Various designs of guard rails are there. Guard stones painted in alternate black and white are usually used. They also give better visibility of curves at night under headlights of vehicles.

## Carriage way

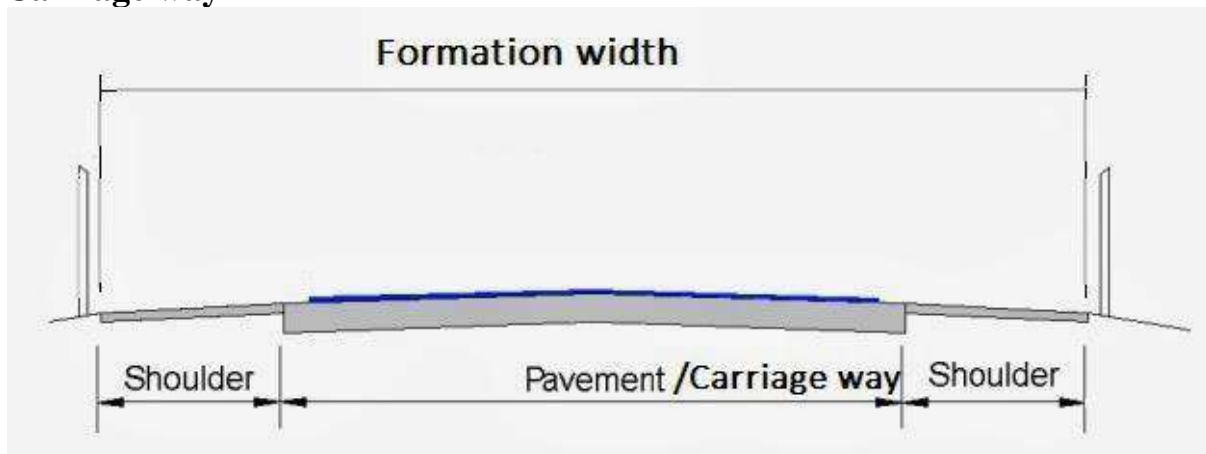

It is the width of the road which is used by the traffic for moving on it. It is generally central portion of the total land width and is paved and surfaced with the bituminous concrete for service to the road users. Width of the carriage way depends on the number of the lanes in the road which again depends on the class of the highway. If it is higher level road like NH then it will need more numbers of lanes and therefore the carriageway width will be more.

## Side slopes

Side slopes are important in maintaining the stability of the roadbed and pavement structure as well as providing an area for the safety of errant vehicles. Side slopes are constructed in both fill (embankment) areas (those falling above the natural ground level) and cut areas (those falling below the natural ground level). As a general reference, slopes in embankment areas are commonly referred to as fill slopes or front slopes. When it is determined that no parallel ditch section is needed the front slope is graded to meet natural ground. In cut

areas, side slopes are referred to as front slopes and back slopes, the back slope being necessary to bring the roadway cross section back up to meet the natural ground level. Ditch sections included as part of either fill or cut sections have a front slope, a ditch bottom with a defined shape and width, and a back slope. Criteria for rates of these slopes (by road classes) are shown in Fig.

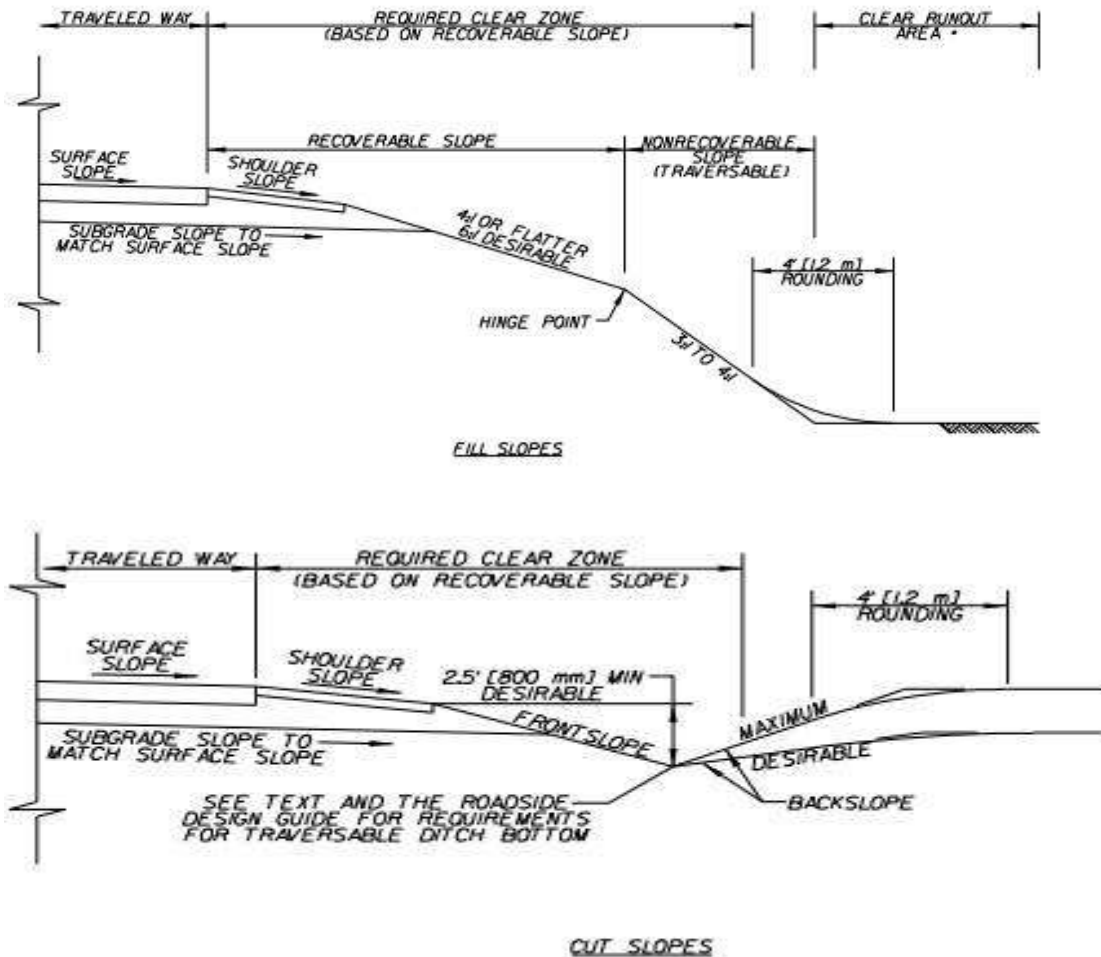

## Kerbs

Kerbs indicate the boundary between the carriage way and the shoulder or islands or footpaths. Different types of kerbs are (Figure ):

1. Low or mountable kerbs : This type of kerbs are provided such that they encourage the traffic to remain in the through traffic lanes and also allow the driver to enter the shoulder area with little difficulty. The height of this kerb is about 10 cm above the pavement edge with a slope which allows the vehicle to climb easily. This is usually provided at medians and channelization schemes and also helps in longitudinal drainage.
2. Semi-barrier type kerbs : When the pedestrian traffic is high, these kerbs are provided. Their height is 15 cm above the pavement edge. This type

of kerb prevents encroachment of parking vehicles, but at acute emergency it is possible to drive over this kerb with some difficulty.

3. Barrier type kerbs : They are designed to discourage vehicles from leaving the pavement. They are provided when there is considerable amount of pedestrian traffic. They are placed at a height of 20 cm above the pavement edge with a steep batter.
4. Submerged kerbs : They are used in rural roads. The kerbs are provided at pavement edges between the pavement edge and shoulders. They provide lateral confinement and stability to the pavement.

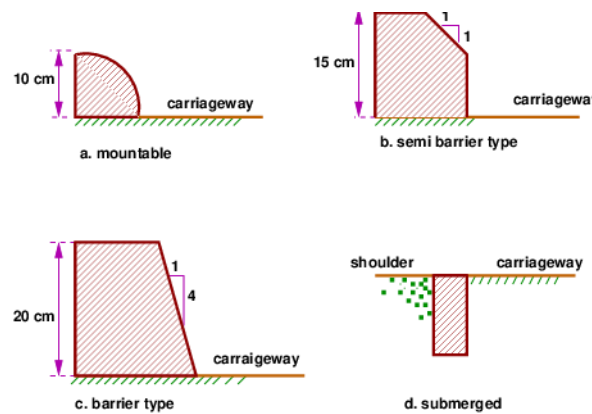

**Figure :** Different types of kerbs

### Formation level

The Formation Level is the level at which excavation ceases and construction commences. It is the lowest point of the path structure. It is the prepared ground on which the sub base layer is laid.

### Camber

Camber or cant is the cross slope provided to raise middle of the road surface in the transverse direction to drain off rain water from road surface. The objectives of providing camber are:

1. Surface protection especially for gravel and bituminous roads
2. Sub-grade protection by proper drainage
3. Quick drying of pavement which in turn increases safety

Too steep slope is undesirable for it will erode the surface. Camber is measured in  $1$  in  $n$  or  $n\%$  (Eg. 1 in 50 or 2%) and the value depends on the type of pavement surface. The values suggested by IRC for various categories of pavement is given in Table 1. The common types of camber are parabolic, straight, or combination of them (Figure )

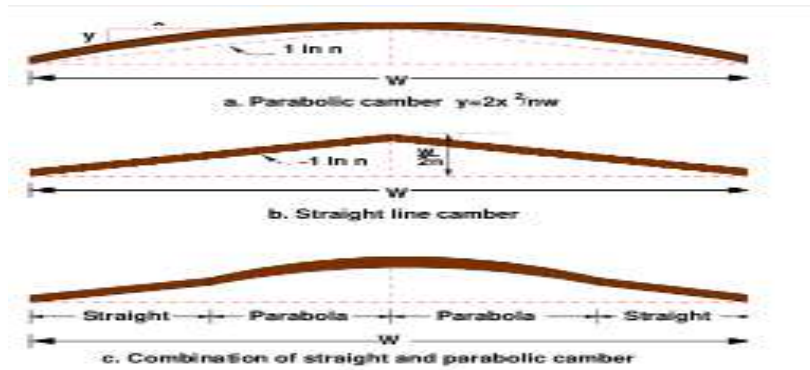

**Figure :** Different types of camber

**Table :** IRC Values for camber

Surface type	Heavy rain	Light rain
Concrete/Bituminous	2 %	1.7 %
Gravel/WBM	3 %	2.5 %
Earthen	4 %	3.0 %

### Gradient

It is the slope provided to the surface of the road in the longitudinal direction for the vertical alignment of the road. There are three kinds of gradients:

- Ruling Gradient
- Limiting Gradient
- Exceptional Gradient
- Minimum Gradient.

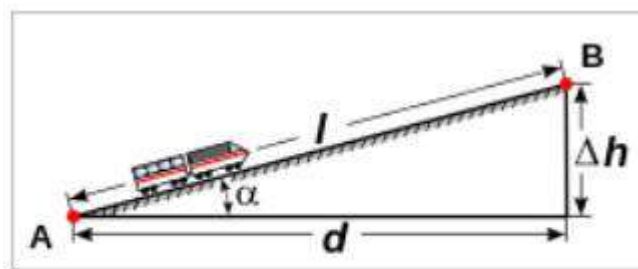

A vehicle on ascending gradient

- **Ruling gradient** is the design gradient, so it is used to design the road in the vertical alignment.
- **Limiting and exceptional gradients** are provided in the limited stretch of the roads where necessary and in case of the emergencies or exceptional cases when such need arises respectively.
- **Minimum gradient** is the gradient which is required as the minimum from the drainage point of view in case of the plane areas.

**Design and average running speed, stopping and passing sight distance**

**Design speed:**

The design speed, as noted earlier, is the single most important factor in the design of horizontal alignment. The design speed also depends on the type of the road. For e.g, the design speed expected from a National highway will be much higher than a village road, and hence the curve geometry will vary significantly.

The design speed also depends on the type of terrain. A plain terrain can afford to have any geometry, but for the same standard in a hilly terrain requires substantial cutting and filling implying exorbitant costs as well as safety concern due to unstable slopes. Therefore, the design speed is normally reduced for terrains with steep slopes.

For instance, Indian Road Congress (IRC) has classified the terrains into four categories, namely plain, rolling, mountainous, and steep based on the cross slope as given in table. Based on the type of road and type of terrain the design speed varies. The IRC has suggested desirable or ruling speed as well as minimum suggested design speed and is tabulated in table .

**Table :** Terrain classification

<b>Table : Terrain classification</b>	
Terrain classification	Cross slope (%)
Plain	0-10
Rolling	10-25
Mountainous	25-60
Steep	60

The recommended design speed is given in Table .

<b>Table : Design speed in as per IRC (ruling and minimum)</b>				
Type	Plain	Rolling	Hilly	Steep
NS&SH	100-80	80-65	50-40	40-30
MDR	80-65	65-50	40-30	30-20
ODR	65-50	50-40	30-25	25-20
VR	50-40	40-35	25-20	25-20

**Terrain classification Cross slope (%)**

Plain 0-10

Rolling 10-25

Mountainous 25-60

Steep 60

The recommended design speed is given in Table .

Table : Design speed in as per IRC (ruling and minimum)

Type	Plain	Rolling	Hilly	Steep
NS&SH	100-80	80-65	50-40	40-30
MDR	80-65	65-50	40-30	30-20
ODR	65-50	50-40	30-25	25-20
VR	50-40	40-35	25-20	25-20

### 1. Topography:

The next important factor that affects the geometric design is the topography. It is easier to construct roads with required standards for a plain terrain. However, for a given design speed, the construction cost increases multiform with the gradient and the terrain. Therefore, geometric design standards are different for different terrain to keep the cost of construction and time of construction under control. This is characterized by sharper curves and steeper gradients.

### 2 Other factors :

In addition to design speed and topography, there are various other factors that affect the geometric design and they are briefly discussed below:

**Vehicle:** The dimensions, weight of the axle and operating characteristics of a vehicle influence the design aspects such as width of the pavement, radii of the curve, clearances, parking geometrics etc. A design vehicle which has standard weight, dimensions and operating characteristics are used to establish highway design controls to accommodate vehicles of a designated type.

**Human:** The important human factors that influence geometric design are the physical, mental and psychological characteristics of the driver and pedestrians like the reaction time.

**Traffic:** It will be uneconomical to design the road for peak traffic flow. Therefore a reasonable value of traffic volume is selected as the design hourly volume which is determined from the various traffic data collected. The geometric design is thus based on this design volume, capacity etc.

**Environmental:** Factors like air pollution, noise pollution etc. should be given due consideration in the geometric design of roads.

**Economy:** The design adopted should be economical as far as possible. It should match with the funds allotted for capital cost and maintenance cost.

**Others:** Geometric design should be such that the aesthetics of the region is not affected.

### **Average running speed**

Running speed is the average speed maintained over a particular course while the vehicle is moving and is found by dividing the length of the course by the time duration the vehicle was in motion. i.e. this speed doesn't consider the time during which the vehicle is brought to a stop, or has to wait till it has a clear road ahead. The running speed will always be more than or equal to the journey speed, as delays are not considered in calculating the running speed

### **Sight Distances**

The safe and efficient operation of vehicles on the road depends very much on the visibility of the road ahead of the driver. Thus the geometric design of the road should be done such that any obstruction on the road length could be visible to the driver from some distance ahead. This distance is said to be the sight distance.

#### **Types of sight distance**

Sight distance available from a point is the actual distance along the road surface, over which a driver from a specified height above the carriage way has visibility of stationary or moving objects. Three sight distance situations are considered for design:

1. Stopping sight distance (SSD) or the absolute minimum sight distance
2. Intermediate sight distance (ISD) is defined as twice SSD
3. Overtaking sight distance (OSD) for safe overtaking operation
4. Head light sight distance is the distance visible to a driver during night driving under the illumination of head lights
5. Safe sight distance to enter into an intersection.

The most important consideration in all these is that at all times the driver travelling at the design speed of the highway must have sufficient carriageway distance within his line of vision to allow him to stop his vehicle before colliding with a slowly moving or stationary object appearing suddenly in his own traffic lane.

The computation of sight distance depends on:

#### **1. Reaction time of the driver**

Reaction time of a driver is the time taken from the instant the object is visible to the driver to the instant when the brakes are applied. The total reaction time may be split up into four components based on PIEV



theory. In practice, all these times are usually combined into a total perception-reaction time suitable for design purposes as well as for easy measurement. Many of the studies shows that drivers require about 1.5 to 2 secs under normal conditions. However, taking into consideration the variability of driver characteristics, a higher value is normally used in design. For example, IRC suggests a reaction time of 2.5 secs.

## **2. Speed of the vehicle**

The speed of the vehicle very much affects the sight distance. Higher the speed, more time will be required to stop the vehicle. Hence it is evident that, as the speed increases, sight distance also increases.

## **3. Efficiency of brakes**

The efficiency of the brakes depends upon the age of the vehicle, vehicle characteristics etc. If the brake efficiency is 100%, the vehicle will stop the moment the brakes are applied. But practically, it is not possible to achieve 100% brake efficiency. Therefore the sight distance required will be more when the efficiency of brakes are less. Also for safe geometric design, we assume that the vehicles have only 50% brake efficiency.

## **4. Frictional resistance between the tyre and the road**

The frictional resistance between the tyre and road plays an important role to bring the vehicle to stop. When the frictional resistance is more, the vehicles stop immediately. Thus sight required will be less. No separate provision for brake efficiency is provided while computing the sight distance. This is taken into account along with the factor of longitudinal friction. IRC has specified the value of longitudinal friction in between 0.35 to 0.4.

## **5. Gradient of the road.**

Gradient of the road also affects the sight distance. While climbing up a gradient, the vehicle can stop immediately. Therefore sight distance required is less. While descending a gradient, gravity also comes into action and more time will be required to stop the vehicle. Sight distance required will be more in this case.

## **Stopping sight distance (SSD)**

Stopping sight distance (SSD) is the minimum sight distance available on a highway at any spot having sufficient length to enable the driver to stop a vehicle travelling at design speed, safely without collision with any other obstruction.

There is a term called *safe stopping distance* and is one of the important measures in traffic engineering. It is the distance a vehicle travels from the point at which a situation is first perceived to the time the deceleration is complete. Drivers must have adequate time if they are to suddenly respond to a situation. Thus in highway design, sight distance at least equal to the safe stopping

distance should be provided. The stopping sight distance is the sum of lag distance and the braking distance. Lag distance is the distance the vehicle travelled during the reaction time  $t$  and is given by  $vt$ , where  $v$  is the velocity in  $m/sec^2$ . Braking distance is the distance travelled by the vehicle during braking operation. For a level road this is obtained by equating the work done in stopping the vehicle and the kinetic energy of the vehicle. If  $F$  is the maximum frictional force developed and the braking distance is  $l$ , then work done against friction in stopping the vehicle is  $Fl = fWl$  where  $W$  is the total weight of the vehicle. The kinetic energy at the design speed is

$$\begin{aligned}\frac{1}{2}mv^2 &= \frac{1}{2} \frac{Wv^2}{g} \\ fWl &= \frac{Wv^2}{2g} \\ l &= \frac{v^2}{2gf}\end{aligned}$$

Therefore, the SSD = lag distance + braking distance and given by:

$$SSD = vt + \frac{v^2}{2gf} \quad (1)$$

where  $v$  is the design speed in  $m/sec^2$ ,  $t$  is the reaction time in  $sec$ ,  $g$  is the acceleration due to gravity and  $f$  is the coefficient of friction. The coefficient of friction  $f$  is given below for various design speed.

**Table 1:** Coefficient of longitudinal friction

Speed, kmph	<30	40	50	60	>80
$f$	0.40	0.38	0.37	0.36	0.35

When there is an ascending gradient of say  $+n\%$ , the component of gravity adds to braking action and hence braking distance is decreased. The component of gravity acting parallel to the surface which adds to the the braking force is equal to  $W \sin \alpha \approx W \tan \alpha = Wn/100$ . Equating kinetic energy and work done:

$$\left(fW + \frac{Wn}{100}\right) l = \frac{Wv^2}{2g}$$

$$l = \frac{v^2}{2g \left(f + \frac{n}{100}\right)}$$

### Overtaking sight distance

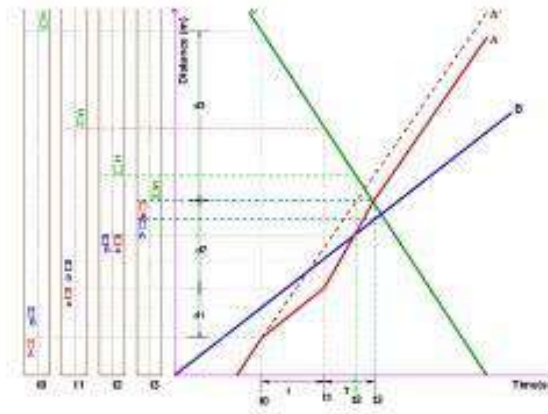

**Figure :** Time-space diagram: Illustration of overtaking sight distance

The overtaking sight distance is the minimum distance open to the vision of the driver of a vehicle intending to overtake the slow vehicle ahead safely against the traffic in the opposite direction. The overtaking sight distance or passing sight distance is measured along the centre line of the road over which a driver with his eye level 1.2 m above the road surface can see the top of an object 1.2 m above the road surface.

The factors that affect the OSD are:

1. Velocities of the overtaking vehicle, overtaken vehicle and of the vehicle coming in the opposite direction.
2. Spacing between vehicles, which in-turn depends on the speed
3. Skill and reaction time of the driver
4. Rate of acceleration of overtaking vehicle
5. Gradient of the road

The dynamics of the overtaking operation is given in the figure which is a time-space diagram. The x-axis denotes the time and y-axis shows the distance travelled by the vehicles. The trajectory of the slow moving vehicle (B) is shown as a straight line which indicates that it is travelling at a constant speed. A fast moving vehicle (A) is travelling behind the vehicle B. The trajectory of the vehicle is shown initially with a steeper slope. The dotted line indicates the path of the vehicle A if B was absent. The vehicle A slows down to follow the vehicle B as shown in the figure with same slope from  $t_0$  to  $t_1$ . Then it overtakes the vehicle B and occupies the left lane at time  $t_3$ . The time duration  $T = t_3 - t_1$  is

the actual duration of the overtaking operation. The snapshots of the road at time  $t_0, t_1$ , and  $t_3$  are shown on the left side of the figure. From the Figure 1, the overtaking sight distance consists of three parts.

1.  $d_1$  the distance travelled by overtaking vehicle A during the reaction time  $t = t_1 - t_0$
2.  $d_2$  the distance travelled by the vehicle during the actual overtaking operation  $T = t_3 - t_1$
3.  $d_3$  is the distance travelled by on-coming vehicle C during the overtaking operation ( $T$ ).

Therefore:

$$OSD = d_1 + d_2 + d_3 \quad (3)$$

It is assumed that the vehicle A is forced to reduce its speed to  $v_b$ , the speed of the slow moving vehicle B and travels behind it during the reaction time  $t$  of the driver. So  $d_1$  is given by:

$$d_1 = v_b t \quad (4)$$

Then the vehicle A starts to accelerate, shifts the lane, overtake and shift back to the original lane. The vehicle A maintains the spacing  $s$  before and after overtaking. The spacing  $s$  in  $m$  is given by:

$$s = 0.7v_b + 6 \quad (5)$$

Let  $T$  be the duration of actual overtaking. The distance travelled by B during the overtaking operation is  $2s + v_b T$ . Also, during this time, vehicle A accelerated from initial velocity  $v_b$  and overtaking is completed while reaching final velocity  $v$ . Hence the distance travelled is given by:

$$\begin{aligned} d_2 &= v_b T + \frac{1}{2} a T^2 \\ 2s + v_b T &= v_b T + \frac{1}{2} a T^2 \\ 2s &= \frac{1}{2} a T^2 \\ T &= \sqrt{\frac{4s}{a}} \\ d_2 &= 2s + v_b \sqrt{\frac{4s}{a}} \end{aligned} \quad (6)$$

The distance travelled by the vehicle C moving at design speed  $v$   $m/sec$  during overtaking operation is given by:

$$d_3 = vT \quad (7)$$

The overtaking sight distance is (Figure 1)

$$OSD = v_b t + 2s + v_b \sqrt{\frac{4s}{a}} + vT \quad (8)$$

where  $v_b$  is the velocity of the slow moving vehicle in  $m/sec^2$ ,  $t$  the reaction time of the driver in  $sec$ ,  $s$  is the spacing between the two vehicle in  $m$  given by equation 5 and  $a$  is the overtaking vehicles acceleration in  $m/sec^2$ . In case the speed of the overtaken vehicle is not given, it can be assumed that it moves 16 kmph slower the design speed.

The acceleration values of the fast vehicle depends on its speed and given in Table .

**Table :** Maximum overtaking acceleration at different speeds

Speed (kmph)	Maximum overtaking acceleration ( $m/sec^2$ )
25	1.41
30	1.30
40	1.24
50	1.11
65	0.92
80	0.72
100	0.53

Note that:

1. On divided highways,  $d_3$  need not be considered
2. On divided highways with four or more lanes, IRC suggests that it is not necessary to provide the OSD, but only SSD is sufficient.

### **Overtaking zones**

Overtaking zones are provided when OSD cannot be provided throughout the length of the highway. These are zones dedicated for overtaking operation, marked with wide roads. The desirable length of overtaking zones is 5 time OSD and the minimum is three times OSD (Figure ).

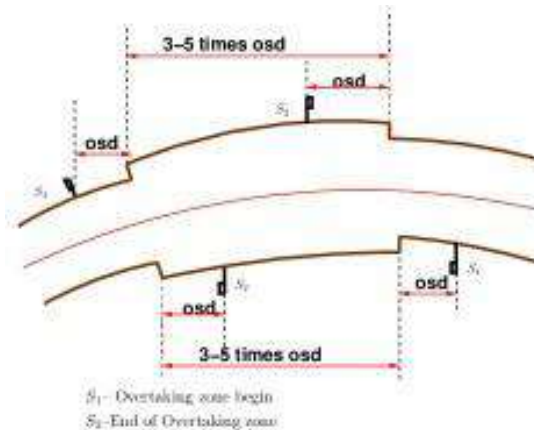

**Figure :** Overtaking zones

### Sight distance at intersections

At intersections where two or more roads meet, visibility should be provided for the drivers approaching the intersection from either sides. They should be able to perceive a hazard and stop the vehicle if required. Stopping sight distance for each road can be computed from the design speed. The sight distance should be provided such that the drivers on either side should be able to see each other. This is illustrated in the figure .

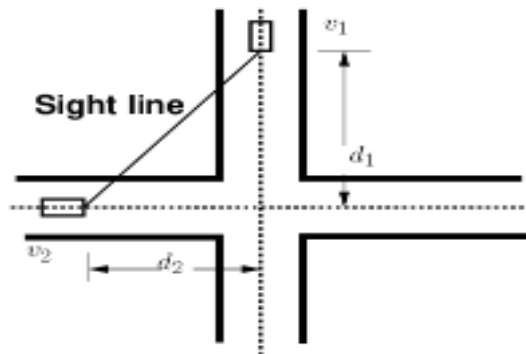

**Figure :** Sight distance at intersections

Design of sight distance at intersections may be used on three possible conditions:

1. Enabling approaching vehicle to change the speed
2. Enabling approaching vehicle to stop
3. Enabling stopped vehicle to cross a main road

### Necessity of curves, horizontal and vertical curves including transition curves and super elevation, Methods of providing super – elevation

#### Definition of Curves:

Curves are regular bends provided in the lines of communication like roads, railways etc. and also in canals to bring about the gradual change of direction.

They are also used in the vertical plane at all changes of grade to avoid the abrupt change of grade at the apex.

Curves provided in the horizontal plane to have the gradual change in direction are known as Horizontal curves, whereas those provided in the vertical plane to obtain the gradual change in grade are known as vertical curves. Curves are laid out on the ground along the centre line of the work. They may be circular or parabolic.

## **Types of Curves**

There are two types of curves provided primarily for the comfort and ease of the motorists in the road namely:

1. Horizontal Curve
2. Vertical Curve

### **Horizontal Curves**

Horizontal curves are provided to change the direction or alignment of a road. Horizontal Curve are circular curves or circular arcs. The sharpness of a curve increases as the radius is decrease which makes it risky and dangerous. The main design criterion of a horizontal curve is the provision of an adequate safe stopping sight distance.

#### **Types of Horizontal Curve:**

##### **Simple Curve:**

A simple arc provided in the road to impose a curve between the two straight lines.

##### **Compound Curve:**

Combination of two simple curves combined together to curve in the same direction.

##### **Reverse Curve:**

Combination of two simple curves combined together to curve in the same direction.

##### **Transition or Spiral Curve:**

A curve that has a varying radius. It is provided with a simple curve and between the simple curves in a compound curve.

While turning a vehicle is exposed to two forces. The first force which attracts the vehicle towards the ground is gravity. The second is centripetal force, which is an external force required to keep the vehicle on a curved path. At any velocity, the centripetal force would be greater for a tighter turn (smaller radius) than a broader one (larger radius). Thus, the vehicle would have to make a very wide circle in order to negotiate a turn.

This issue is encountered when providing horizontal curves by designing roads that are tilted at a slight angle thus providing ease and comfort to the driver while turning. This phenomenon is defined as super elevation, which is

the amount of rise seen on a given cross-section of a turning road, it is otherwise known as slope.

### Vertical Curves

Vertical curves are provided to change the slope in the road and may or may not be symmetrical. They are parabolic and not circular like horizontal curves. Identifying the proper grade and the safe passing sight distance is the main design criterion of the vertical curve, crest vertical curve the length should be enough to provide safe stopping sight distance and in sag vertical curve the length is important as it influences the factors such as headlight sight distance, rider comfort and drainage requirements.

### Types of Vertical Curve:

#### Sag Curve

Sag Curves are those which change the alignment of the road from uphill to downhill,

#### Crest Curve/Summit Curve

Crest Curves are those which change the alignment of the road from downhill to uphill. In designing crest vertical curves it is important that the grades be not too high which makes it difficult for the motorists to travel upon it.

### Super elevation :

When a vehicle travels in a circular path or curved path, it is subjected to an outward force which makes a vehicle to overturn and skid due to Centrifugal force. To overcome this force and for safe travel of a vehicle, **the outer edge of the road is raised above the inner edge. This is known as superelevation or banking of road.**

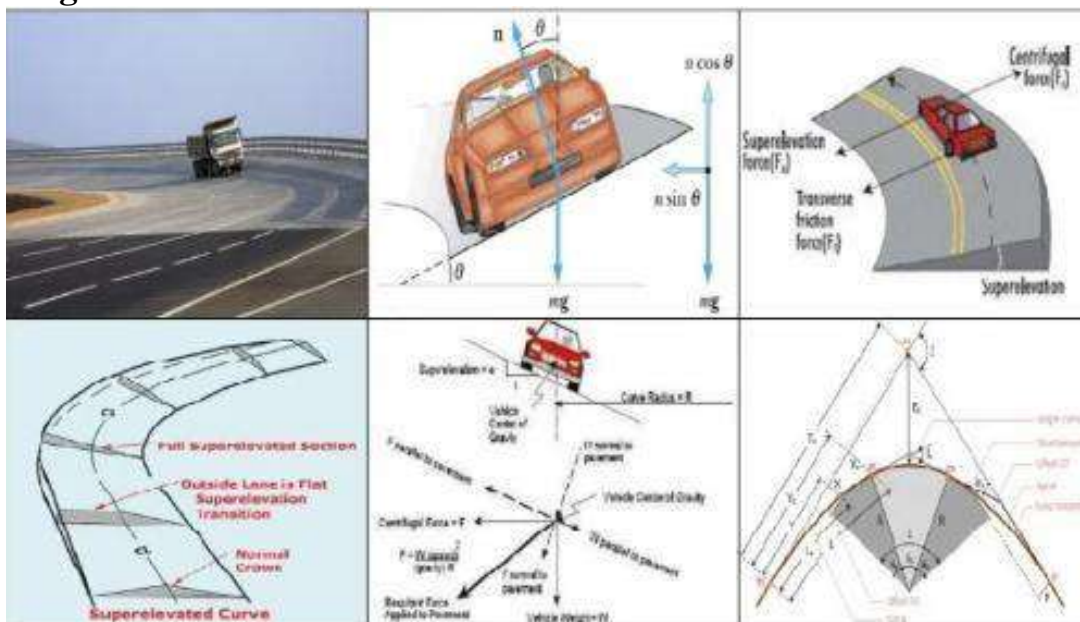

**Super-Elevation / Banking of road** reduces the effect of centrifugal force on the running wheels. If super-elevation is not provided with the entire centripetal



force is produced by the friction between the vehicle's tires and the roadway, thus results in reducing the speed of a vehicle.

**Advantages of providing Super elevation:-**

1. Super elevation is provided to achieve the higher speed of vehicles. It increases the stability of fast-moving vehicles when they pass through a horizontal curve, and it also decreases the stresses on the foundation.
2. In the absence of super elevation on the road along curves, potholes are likely to occur at the outer edge of the road.
3. The Indian road congress(IRC) has prescribed the max value of Super Elevation is 1 in 15.

**Derivation of Super Elevation :**

When a vehicle passes from a straight to a curved path or in other words when a vehicle negotiates horizontal curve following two forces act on vehicle:

1. Centrifugal Force
2. Weight of the Vehicle

**1. Centrifugal Force** - The centrifugal force is a function of the speed of the moving vehicle. It always acts at the centre of gravity of the vehicle. It's direction always tends to outside, i.e., it always tends to push the vehicle out of the track. to counteract this tendency, the outer edge of the road is raised above the inner edge. **This rise of the outer edge is called super-elevation or cant or banking.**

Thus super-elevation  $e$  is the ratio of the height of the outer edge with respect to the horizontal width.

$$e = \tan \theta$$

In practice, the value of  $\theta$  is kept as  $4^\circ$  or a slope of 1 in 15 with horizontal.

The total height of the outer edge with respect to the inner edge

$$\begin{aligned} E &= e \times \text{width of road} \\ &= e B \end{aligned}$$

The centrifugal force  $P = Wv^2/gR$

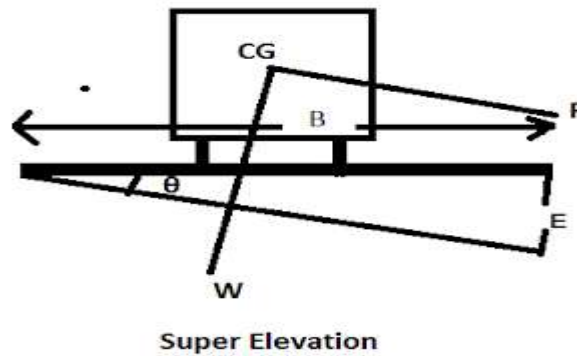

Where,

W = weight of the vehicle

v = velocity of the vehicle

R = radius of circular curve

P = centrifugal force

g = acceleration due to gravity

### 1. Effect of Centrifugal Force

1. The tendency to overturn the vehicle.
2. The tendency to skid the vehicle laterally.

### Stability Condition Against Overturning

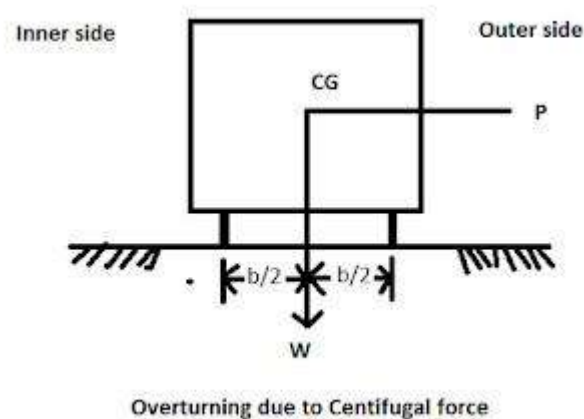

The figure shows a vehicle moving on horizontal a curve. Forces acting on the vehicle are

- a.) Centrifugal force P acting outward at C.G.
- b.) Weight W acting downward at C.G.

Let h be the height of C.G. of the vehicle above the road level.

The overturning moment due to centrifugal force.

$$= P \times h$$

The restoring moment  $= W \times b/2$

where  $b$  is the centre to centre distance of wheels of the vehicle.

in limiting equilibrium

$$Ph = Wb/2$$

$$P/W = b/2h$$

When the centrifugal ratio,  $P/W$  is equal to  $B/2h$  there is a danger of overturning.

Thus to avoid overturning, the centrifugal ratio should always be less than  $b/2h$ .

Also  $P/W = v^2/gR$

$$v^2/gR < b/2h$$

Thus to avoid overturning  $h$  should be as small as possible. Only due to this reason modern passenger cars have a low centre of gravity.

### Stability Condition Against Skidding

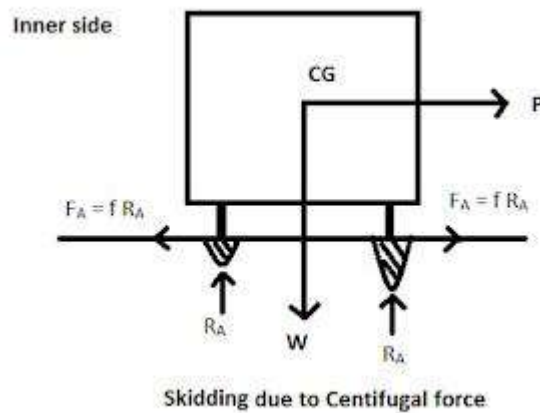

The lateral thrust  $P = Wv^2/gR$  is resisted by the frictional force between the tyre and pavement surface. If the lateral resisting friction is less than the centrifugal force  $P$ , then skid will occur. Thus in limiting equilibrium,  $P =$  Maximum lateral friction developed as shown in the figure.

$$P = F_a + F_b$$

$$\text{or } P = f (R_A + R_B)$$

$$= fW$$

$$\text{Or } P/W = f$$

Thus when the centrifugal ratio attains the value equal to the lateral coefficient of friction, there is a danger of lateral skidding.

If  $f < b/2h$  skidding would occur.

If  $f > B/2h$  overturning at the outer edge would occur.

### Methods of providing super – elevation :

Super-elevation is designed for the particular vehicle called design vehicle which has some standard weight and dimensions. But in the actual case, the road has mixed traffic conditions. Different vehicles require different values of super-elevation. For example Heavily loaded trucks require the small value of super-elevation otherwise toppling may occur, fast moving vehicles may be provided with high super-elevation while slow moving ones require small super-elevation. The design procedure for super-elevation is as follows:

**Step 1** Find value of super-elevation taking 75% of design speed neglecting  $f$ ,

$$\text{Hence, } e = (0.75v)^2 / (g \cdot R)$$

**Step 2** If value of  $e$  is less than 0.07 then it is taken for design otherwise value of  $e$  is taken as 0.07.

**Step 3** Find value of frictional coefficient ( $f$ ) with full design speed regarding maximum super-elevation.

$$\text{Hence, } f = v^2 / (g \cdot R) - e = v^2 / (g \cdot R) - 0.07$$

**Step 4** If value for  $f$  is less than 0.15 then it is taken for design otherwise value for  $f$  is taken as 0.15.

**Step 5** The allowable speed for maximum value of  $e = 0.07$  and  $f = 0.15$  is calculated

$$\text{Hence, Allowable speed } (V_a) = \sqrt{(0.22g \cdot R)}$$

If the allowable velocity is greater than or equal to  $v$  then the design is adequate otherwise other speed control measures are adopted.

Different guidelines are given in NRS for the design of horizontal curvature.

In terms of velocity in kmph it is calculated as,

$$\text{Or, } V^2 / (126.5 \cdot R) = e + f$$

$$\text{And, } V_a = \sqrt{[126.5 \cdot R \cdot (e + f)]}$$

### Methods of introducing superelevation:

Superelevation is introduced in two ways usually

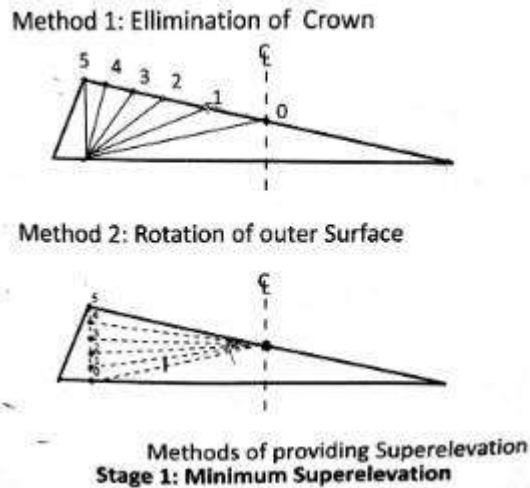

### 1. Elimination of the crown of the cambered section

- The outer edge half of the cross slopes is rotated about the crown at the desired rate such that its surface falls on the same plane as the inner half.
- The position of the crown is progressively shifted outwards which increases the width of the inner half of the cross-section progressively. It is also called as the diagonal crown method.

### 2. Rotation of the pavement cross section to attain full superelevation

- Rotation about the center line: It is mostly preferred by the majority of designers. This method involves progressively revolving the straight road surface about the center line depressing the inner edge and raising the outer edge simultaneously by an amount of half the total amount of superelevation. Thus the earthwork is the balanced i.e. volume of cutting and filling required in this method will be equal. Due to depressing inner edge below general level, the disadvantage of this method is drainage.
- Rotation about the inner edge: This method involves progressively revolving the straight road surface about the inner edge thereby raising the center line and the outer edge proportionately to the desired slope. Here the outer edge is raised by the full amount of superelevation. This method is preferred in very flat terrain in high rainfall areas in order to avoid drainage problem. The rise of the center line is considered a disadvantage in this method since the vertical alignment of the road is altered.
- Rotation about the outer edge: This method involves progressively revolving the straight road surface about the outer edge thereby depressing the center line and the outer edge proportionately to the desired slope. Here the inner edge is depressed by the full amount of superelevation with respect to the outer edge. This method is similar to the rotation about the inner edge.

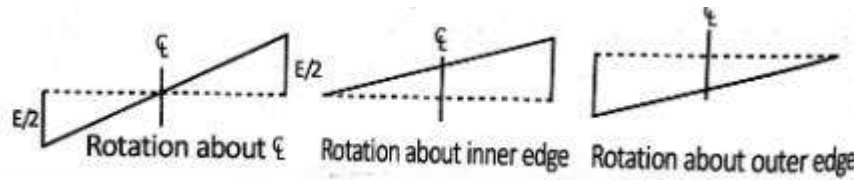

### **EXTRA WIDENING**

On a horizontal curve especially when there are not many very large radius, it is common to widen the pavement or carriageway slightly more than the normal width. This additional increase in the width of the pavement is termed as extra widening. The reasons of providing extra widening are given below:

1. Due to the rigidity of rear wheel base of the vehicle moving along the curve they don't trace the same path as taken by the front steering wheels. This is called off tracking. During this case, mechanical widening is required.
2. Due to the psychological tendency of drivers, drivers tend to take the outer lane for greater visibility and easy gradient at the beginning of the curves. So extra width is provided.
3. Drivers have the tendency to keep greater clearance between opposite vehicles on curves when road visibility is inadequate.
4. Drivers have the tendency to keep away from the edge of the carriageway while driving on curves.
5. When traveling in a curved path more space is occupied by the vehicles during turning.
6. Trailer units require even larger extra width at curves.
7. At speeds higher than the design speed outward slipping of the rear wheel may occur due to centrifugal force and thus more width of the road is covered. Even in lower speeds, the front tires tend to go out of the pavement and thus extra widening is required.
8. The extra width is provided to ensure safe and efficient overtaking operations.
9. The amount of extra widening required depends on the following factors:
  1. Length of the wheel base of the vehicle
  2. Psychological factor
  3. Radius of the curve

The analysis of extra widening is done in two parts namely:

1. Mechanical widening
2. Psychological widening

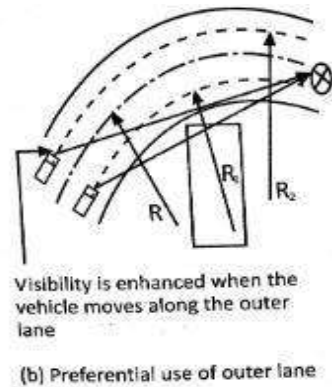
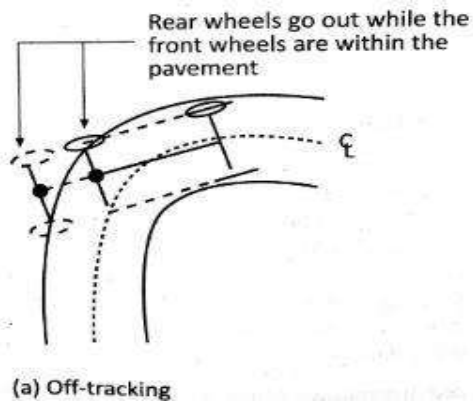

## 1. Mechanical widening

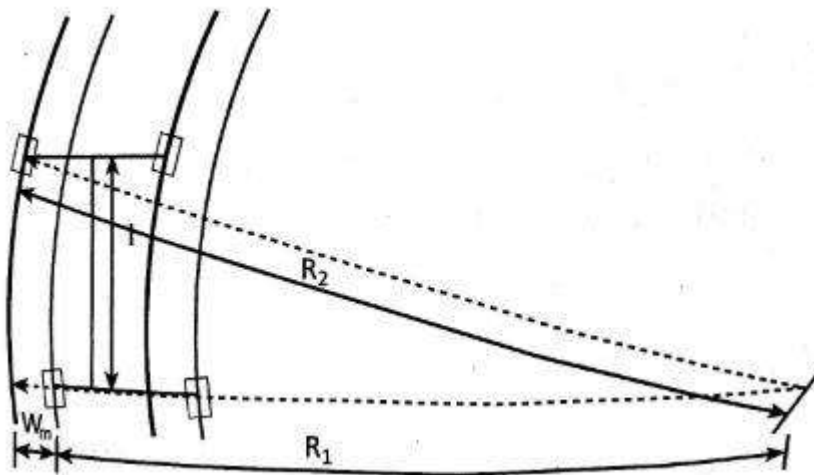

It is the amount of the extra width required to account for the off tracking of the vehicle due to the rigidity of the rear wheel base. Due to off tracking, the rear wheels follow a path of shorter radius than the front ones and thus it increases the effective width of road space required by the vehicle. So we provide extra width to provide same clearance between vehicles, to provide safety against transverse skidding during high speeds and also to provide stability for vehicles like trailer trucks. Thus it is an important factor during operation of high proportions of vehicles.

Let  $R_1$  be the radius of the path travelled by the outer track line of the rear wheel,  $R_2$  be the radius of the path travelled by the outer track line of the front wheel and  $l$  be the distance between the front and rear wheels. Then the mechanical widening is given by:

$$W_m = R_2 - R_1$$

$$\text{Or, } R_1 = R_2 - W_m$$

From the triangle, we can say that,

$$R^2 = R_1^2 + l^2$$

$$\text{Or, } R^2 = (R_2 - W_m)^2 + l^2$$

$$\text{Or, } R^2 = R_2^2 - 2 * R_2 * W_m + W_m^2 + l^2$$

$$\text{Or, } l^2 = 2 * R_2 * W_m - W_m^2$$

Hence the widening required will be,

$$W_m = l^2 / (2 * R_2 - W_m)$$

For large radius  $R_1 \approx R_2$  which is the mean radius of the curve,  $W_m$  becomes very small in comparison to  $R$  then the mechanical widening is given by:

$$W_m = l^2 / (2 * R)$$

For  $n$  number of lanes,

$$W_m = (n * l^2) / (2 * R)$$

## 2. Psychological widening

It is the amount of additional width required due to various psychological reasons i.e. for greater maneuverability, for confidence, for the tendency to maintain greater clearance between vehicles, for the tendency of drivers to drive close to the edges of the pavement on curves, etc. which the driver will be needing is termed as psychological widening. It is very difficult to assess so IRC has proposed an empirical relation for the psychological widening.

$$W_{psy} = v / (2.64 * \sqrt{R})$$

Where,  $W_{psy}$  is the psychological widening,  $v$  is the velocity in m/s and  $R$  is the radius in meter.

In terms of kmph,

$$W_{psy} = v / (9.5 * \sqrt{R})$$

Therefore the total widening required at a horizontal curve is,

$$W_e = W_m + W_{psy} = (n * l^2) / (2 * R) + v / (9.5 * \sqrt{R})$$

Where,  $v$  is in kmph.

## ROAD MATERIALS

### Difference types of road materials in use: soil, aggregates, and binders

A wide variety of materials are used in the construction of roads these are soils (naturally occurring or processed), aggregates (fine aggregates or coarse aggregates obtained from rocks), binders like lime, bituminous materials, and cement, and miscellaneous materials used as admixtures for improved performance of roads under heavy loads and traffic.

Soil constitutes the primary material for the foundation, subgrade, or even the pavement (for low-cost roads with low traffic in rural areas). When the highway is constructed on an embankment at the desired level, soil constitutes the primary embankment material; further, since all structures have to ultimately



rest on and transmit loads to 'mother earth', soil and rock also serve as foundation materials.

Soil is invariably used after some process of stabilisation such as compaction and strengthening by adding suitable admixtures for improving the performance of the road. Mineral aggregates obtained from rocks form the major component of the sub-bases and bases of highway pavements of almost all types.

### **1. Soil:**

Soils can be studied effectively if they are classified according to certain principles into a definite system. A system is an ordered grouping of certain elements in a discipline according to pre-defined principles. Just as classification or grouping is practised in scientific disciplines such as chemistry, zoology and botany, it is used in Geotechnical Engineering as well.

A soil classification system may be defined as a fundamental division of the various types of soil into groups according to certain parameters such as its physical properties, constituents or texture, field performance under load, presence of water and so on. There are a few field identification tests have been developed for preliminary identification in the field.

### **Need for Soil Classification:**

Soil deposits in nature are never homogenous in character; wide variations are observed in their properties and behaviour. Soils that exhibit similar average properties may be grouped as a class. Classification of soil is necessary to obtain an appropriate and fairly accurate idea of the properties and behaviour of a soil type.

A classification system is usually evolved with a view to assessing the suitability of a soil for specific use as a construction material or as a foundation material. In view of the wide variations in engineering properties of several soils, it is inevitable that in any system of classification, there will be borderline cases which may fall into groups that appear to be radically different under different systems of classification.

Hence, classification is taken only as a preliminary requirement to study the engineering behaviour of a soil; special tests may become necessary in any project of importance.

### **Requirements of a Soil Classification System:**

**The general requirements of an ideal soil classification system are:**

- i. It should have a scientific basis.
- ii. It should be relatively simple and objective in approach.

- iii. The number of groupings and properties used as the criteria should be limited.
- iv. The properties considered should be relevant to the purpose of classification.
- v. A generally accepted uniform soil terminology should be used.
- vi. It should indicate the probable performance of the soil to a satisfactory degree of accuracy.
- vii. Group boundaries should be drawn as closely as possible where significant changes in soil properties occur.
- viii. It should be acceptable to all engineers.

**Although several classification systems have been developed, some being relatively more elaborate and exhaustive than others, the following systems only will be considered:**

- (a) Textural classification
- (b) PRA system of classification (Group index method)
- (c) Unified soil classification System
- (d) Indian Standard Soil classification system

## **2. Stone Aggregates:**

Stone aggregate, or mineral aggregate, as it is called, is the most important component of the materials used in the construction of roads. These aggregates are derived from rocks, which are formed by the cementation of minerals by the forces of nature.

Stone aggregates are invariably derived by breaking the naturally occurring rocks to the required sizes. They are used for granular bases, sub-bases, as part of bituminous mixes and cement concrete; they are also the primary component of a relatively cheaper road, called water-bound macadam.

A study of the types of aggregates, their properties, and the tests to determine their suitability for a specific purpose is of utmost importance to a highway engineer. Properties such as strength and durability of aggregates are generally influenced by their origin of occurrence, mineral constituents and the nature of the bond between the constituents.

### **Geological Classification of Rocks:**

**Geologically speaking, rocks are classified into the following categories:**

#### **(a) Igneous Rocks:**

These are formed by the cooling, solidification and crystallisation of molten rock on the earth's crust at different depths. The minerals, their proportions and the rate of cooling of the magma have a bearing on the strength characteristics of the rock.

Igneous rocks are, in general, stronger than the other two types. Granite, diorite and gabbro are intrusive rocks which form at deep layers in the earth's crust.

Basalt (or trap), andesite, rhyolite and dolerite are extrusive rocks which form at the top layers of the earth's crust.

**(b) Sedimentary Rocks:**

Fine material or rock fragments and particles transported by water or wind and deposited in layers, get hardened in course of time to form sedimentary rocks (the time required is on geologic scale). They consist of a layered structure; the rock beds are stratified, they may be porous, and have relatively low strength.

Examples of siliceous variety are sandstone and argillite; those of calcareous variety are limestone and dolomite.

**(c) Metamorphic Rocks:**

These are formed by the modification and re-crystallisation of igneous rocks and sedimentary rocks by geological and natural agents such as temperature, pressure, moisture, humidity, and movement of rock beds.

Major changes occur in geologic time and form foliations. This kind of foliated structure makes these rocks comparably weaker than igneous rocks. Popular examples of metamorphic rocks are gneiss (from granite), slate (from shale) and schist.

Examples of un-foliated types are marble (from limestone) and quartzite (from sandstone). (Marble and gneiss are used for flooring and face work in buildings.)

**Desirable Properties of Sand Aggregates:**

**The following properties are desirable in soil aggregates used in the construction of roads:**

**(i) Strength:**

It is the resistance to crushing which the aggregates used in road construction, especially in the top layers and wearing course, have to withstand the stresses due to wheel loads of the traffic in addition to wear and tear.

**(ii) Hardness:**

It is the resistance to abrasion of the aggregate at the surface. The constant rubbing or abrading action between the tyres of moving vehicles and the exposed aggregate at the road surface should be resisted adequately.

**(iii) Toughness:**

This is the resistance to impact due to moving traffic. Heavily loaded trucks and other vehicles cause heavy impact loads on the road surface while moving at high speeds, and while accelerating and decelerating. Even steel-tired vehicles, though moving slow, cause heavy impact on the aggregates exposed at the surface. Hence, resistance to such impact forces is a desirable quality.

**(iv) Durability:**

It is the resistance to the process of disintegration due to the weathering action of the forces of nature. The property by virtue of which the aggregate withstands weathering is called soundness. This is also a desirable property.

**(v) Cementation:**

It is the ability of the aggregate to form its own binding material under traffic, providing resistance to lateral displacement. Limestone and laterite are examples of stones with good cementing quality. This becomes important in the case of water-bound macadam roads.

**(vi) Appropriate Shape:**

Aggregates may be either rounded, cubical, angular, flaky, or elongated. Each shape is appropriate for a certain use. Too flaky and too elongated aggregates have less strength and durability; so they are not preferred in road construction. Rounded aggregates are good for cement concrete because of the workability such aggregates provide. Cubical or angular aggregates have good interlocking properties; since flexible pavements derive their stability due to interlocking, such aggregates are the preferred type for construction. Thus, the appropriate shape for a particular use is also a desirable property.

**(vii) Adhesion with Bitumen:**

The aggregates used in bituminous pavements should have less affinity to water than to bitumen; otherwise, the bituminous coating on the surface of the aggregate will get stripped off in the presence of water. So, hydrophobic characteristic is a desirable property for aggregates to be used in the construction of bituminous roads.

**(viii) Attrition:**

This is mutual rubbing of aggregates under traffic; adequate resistance to attrition is a desirable property.

**(ix) Texture:**

This is a measure of the degree of fineness or smoothness of the surface of the aggregate.

Gravels from river beds are fairly smooth; as a rule, fine grained rock is highly resistant to wear and is preferred for surface courses.

**3. Bituminous Materials:**

Bitumen was used as a bonding and water-proofing agent thousands of years ago. However, the use of bitumen for road-making picked up only in the nineteenth century. As the quest for fuels like petroleum to run automobiles grew and the distillation of crude oil emerged as a major refining industry, the residues known as bitumen and tar found increasing use in constructing bituminous surfaces, which provided superior riding surface.

**The definition for the term, bitumen, given by the American Society for Testing Materials (ASTM) runs thus:**

“Bitumen is a hydrocarbon material of natural or pyrogenous origin, which is in a gaseous, liquid, semi-solid, or solid state, and which is completely soluble in carbon disulphide (CS<sub>2</sub>).”

Of course, bitumen is found to be soluble to a large extent in carbon tetrachloride (CCl<sub>4</sub>) also. Bitumen is a complex organic compound and occurs

either as such in nature or can be obtained during the distillation of petroleum; it is generally non-volatile and resistant to most acids, alkalis and salts.

Bitumen occurring in nature as rock intrusions invariably contains inert inorganic materials or minerals; in such a case it is called asphalt. It is also found in lakes (as in Trinidad), in which case it is called lake asphalt. However, in American terminology, bitumen itself is termed asphalt, irrespective of whether it contains inorganic/mineral matter or not. In India, the British terminology is used for the terms bitumen and asphalt.

**Important Properties of Bitumen:**

1. Predominantly hydrocarbons, with small quantities of sulphur, nitrogen and metals.
2. Mostly (up to 99.9%) soluble in carbon disulphide (CS<sub>2</sub>), and insoluble in water.
3. Softens on heating and gets hardened on cooling.
4. Highly impermeable to water.
5. Chemically inert and unaffected by most acids, alkalis and salts.
6. No specific boiling point, melting point or freezing point; a form of 'softening point' is used in their characterisation.
7. Although generally hydrophobic (water repellent), they may be made hydrophilic (water liking) by the addition of a small quantity of surface-active agent.
8. Most bitumens are colloidal in nature.

**Desirable Properties of Bitumen as a Road Material:**

1. Workability – Bitumen should be fluid enough at the time of mixing so that the aggregates are fully coated by the binder. Fluidity is achieved either by heating or by cutting back with a thin flux or by emulsifying the bitumen.
2. Durability – There should be little change in viscosity within the usual range of temperatures in the locality.
3. Volatile constituents in bitumen should not be lost excessively at higher temperatures to ensure durability.
4. It should have enough ductility to avoid brittleness and cracking.
5. Strength and adhesion – The bitumen should have good affinity to the aggregates and should not be stripped off in the continued presence of water.
6. Cost-effectiveness.

**A few more terms relating to bitumen/asphalt are:**

**Straight-Run Bitumen:** Bitumen derived from the refining of petroleum for which the viscosity has not been adjusted by blending with flux oil or by

softening with any cut-back oil or by any other treatment. It generally has high viscosity.

**Asphalt Cement:**

A binder consisting of bitumen, or a mixture of lake asphalt and bitumen or flux oils, specially prepared as per prescribed quality and consistency for direct use in paving, usually in the hot condition.

**Oxidised or Blown Bitumen:**

Bitumen obtained by further treatment of straight-run bitumen by running it, while hot, into a vertical column and blowing air through it. In this process, it attains a rubbery consistency with a higher softening point than before.

**Cut-Back Bitumen:**

Asphalt/bitumen dissolved in naphtha or kerosene to lower the viscosity and increase the workability.

**Emulsified Bitumen:**

A mixture in which asphalt cement, in a finely dispersed state, is suspended in chemically treated water.

**Liquid Bitumen:**

Include cut-backs in naphtha and kerosene, as also emulsified asphalts.

**Flux-Oil:**

A bituminous material, generally liquid, used for softening other bituminous materials.

**Bitumen from Petroleum Refining:**

The main source of bitumen is petroleum crude. Refining of petroleum crude involves fractional distillation. The crude oil is heated in a tube-still to about 200°C to 400°C and injected into a fractionating column. As the pressure is suddenly reduced, the volatile fractions with low boiling points get vaporised and go up the column, from where they are carried through condensers.

Gasoline, kerosene, diesel oil, and lubricating oils, constituting the light, medium and heavy distillates with gradually increasing boiling points, thus get collected. The heavy residue left at the bottom is collected as bitumen. Steam is injected into the fractionating column to help in the separation process of the fractions. The steam and vacuum distillation process is only a physical process and does not involve any chemical changes.

In modern refining processes, the distillation is carried out in stages. In the first stage, the temperature in the tube-still is kept relatively low (say 300°C to 350°C) and the light and medium fractions are separated in the fractionating column operating at atmospheric pressure.

The crude left is then passed through another still for subsequent transfer to another column operating under vacuum and injected with steam. The latest process dispenses with steam and relies on dry vacuum only, thus enabling a wide range of bitumen to be produced.

Paraffinic crudes yield, on distillation, an undesirable wax-like residue. Naphthenic crudes yield practically wax-free bitumen; crude from middle-east yields good bitumen. The heavy residue may be blown with air at high temperature in a converter to produce air-blown or oxidised bitumen.

They are stiff even at high atmospheric temperatures. Such bitumen are not used for pavements, but are good as roofing materials and water-proof paints. It is also used as filler material for cracks and joints in concrete pavements.

**A schematic flow-chart for petroleum refining is shown in Fig.**

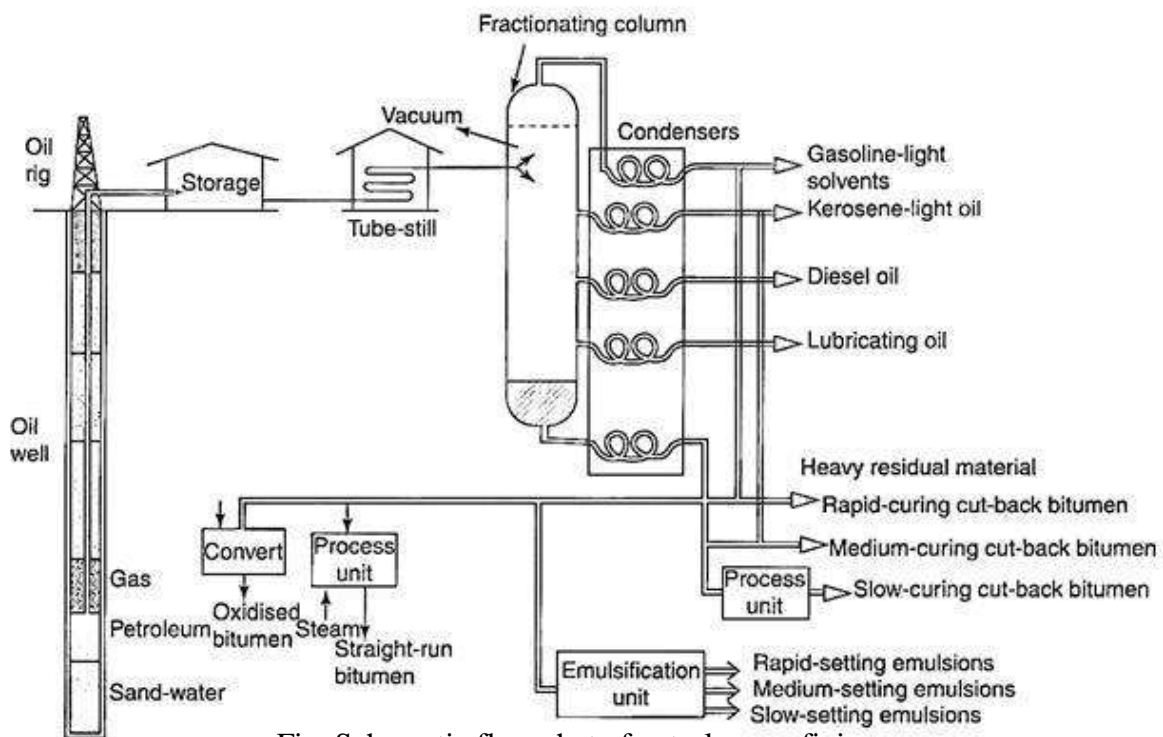

Fig. Schematic flow chat of petroleum refining

### **Cut-Back Bitumen:**

Cut-back bitumen is one, the viscosity of which is reduced by adding a volatile diluent. Penetration grade bitumens require to be heated to a specified temperature to lower its viscosity before it is applied on a road to facilitate coating the pre-heated aggregate. To obviate the need for heating the aggregate, cut-backs come in handy. Upon application, the volatiles slowly evaporate, and leave behind the original bituminous binder.

**There are three types of cut-backs based on the diluent (dilutant or solvent) used:**

1. Rapid-curing (RC) cutback – Bitumen blended with gasoline or naphtha, (highly volatile, low viscosity)
2. Medium-curing (MC) cutback – Bitumen blended with kerosene or coal tar creosote oil (medium viscosity)
3. Slow-curing (SC) cutback – Bitumen blended with gas oil (low viscosity, highly viscous)

**Each of these has been categorized based on their initial kinematic viscosity values as follows:**

1. RC 70, RC 250, RC 800, RC 3000
2. MC 30, MC 70, MC 250, MC 800, MC 3000
3. SC 70, SC 250, SC 800, SC 3000

Further details and specifications for these cutbacks are given in “IS: 217-1988: Specification for cutback bitumen, Bureau of Indian Standards, New Delhi, 1993”.

Since cutbacks contain volatile solvent, some of which may enter water bodies and air, they may cause environmental pollution. Also, since the solvent is inflammable, it may increase the possibility of fire hazard and cause concerns related to safety during handling and application. Therefore, cutbacks are being gradually replaced by emulsions.

#### **Bitumen Emulsions:**

A bitumen emulsion is obtained by blending bitumen with water and an additive called an emulsifier. The emulsified suspension contains dispersed minute particles of bitumen (that is, oil in water). In a bituminous emulsion, bitumen is the ‘dispersed’ phase (minutely subdivided particles), while water is the ‘continuous’ phase in which it is not soluble. The amount of bitumen to be mixed with water may range from 40 to 70% depending upon the intended use of the suspension.

Based on the type of emulsifier used, the bitumen particles can be negatively charged or positively charged. If they are negatively charged, ‘anionic bitumen emulsions’ are obtained, and if they are positively charged, ‘cationic emulsions’ are got.

Fatty acids derived from mineral, vegetable or wood sources saponified with sodium or potassium hydroxide are used as emulsifiers for producing anionic emulsion. For cationic emulsions, the emulsifiers are generally amine salts produced by the reaction of organic amine or diamine with acetic acid or hydrochloric acid.



The type of emulsion should be selected based on the mineral composition of the aggregate used for the bituminous mix. For example, for an aggregate rich in silica ( $\text{SiO}_2$ ) which has a strong electronegative charge on the surface, cationic emulsions are suitable with electropositive charge on the suspended bitumen particles. The mix then becomes electrostatically stable and produces a strong layer when compacted.

**Bitumen emulsions, like cutback bitumens, are also classified into three types based on their setting times:**

1. Rapid-setting emulsions (RS)
2. Medium-setting emulsions (MS)
3. Slow-setting emulsions (SS)

Setting, in this context, means separation of the emulsion. When the water in the emulsion evaporates, the minute bitumen particles in the emulsion coat the surface of the aggregates; curing takes place, by which the compacted layer of the emulsion-aggregate mix hardens and attains strength. Therefore, rapid-setting emulsion sets and cures in a relatively quick manner.

“IS: 3117-2004: Anionic bitumen emulsions” covers anionic emulsions, while “IS: 8887- 2004: Cationic bitumen emulsions” covers cationic emulsions.

**Setting and curing of emulsion mixes are affected by the following factors:**

- I. Gradation, dust, dampness, water absorption and mineral composition and surface charge of/on the aggregates.
- II. Ingredients and quantity of the emulsion used.
- III. Meteorological conditions like climate, weather, temperature, humidity, wind velocity, etc.
- IV. Drainage conditions of the construction site.

**Advantages of Emulsions:**

1. Emulsions can be used under cold and damp weather conditions.
2. Strength properties of bitumen are preserved as they do not need hot mixing.
3. Better coating of aggregates due to low viscosity of the emulsion.
4. Ideal for patch repair work and sealing of cracks as no heating is required and better penetration into even minute cracks is possible.
5. Water-based nature of the emulsions makes them environment-friendly.
6. A lot of energy is conserved as there is no need for intensive heating (only warming is needed, if at all.)

**Limitations of Emulsions:**

1. The nature of the aggregate has to be verified before choosing an appropriate emulsion.

2. Setting time varies not only with the type of emulsion, but also with atmospheric conditions at the time of application.
3. Based on the particular need, care should be exercised in choosing the type of emulsion and the quantity needed for the desired grade of bituminous mix.
4. Storage time is relatively restricted.
5. Bitumen emulsions are more expensive than hot-mix bitumen.
6. In general, emulsion-based bituminous pavements using emulsions are not as good as hot- mix constructions for heavy traffic loads.

**Tar:**

Tar is a black or brown to black, viscous, non-crystalline material having binding property. This is, therefore, the other category of bituminous materials.

Tar is obtained from the destructive distillation of organic materials such as coal, petroleum, oil, wood and peat, in the absence of air at about 1000°C. It is completely soluble in carbon tetrachloride (CCl<sub>4</sub>). It contains more volatile constituents than bitumen and is therefore more susceptible to change in temperature. Generally, tar is used for surface dressing on the wearing course since it has good adhesion in damp conditions.

**Some more terms relating to tar are:**

- i. Coal tar – Tar produced by the destructive distillation of bituminous coal.
- ii. Coke-oven tar – A variety of coal tar obtained as a by-product from the destructive distillation of coal in the production of coke.
- iii. Oil-gas tar – A petroleum tar produced by cracking oils at high temperature in the production of oil-gas.
- iv. Water-gas tar – A petroleum tar produced by cracking oils at high temperature in the production of carburetted water-gas.
- v. Refined tar – Produced from crude tar by distillation to remove water and to produce a residue of desired consistency.
- vi. Road tar – A tar refined in quality and consistency for use in paving of roads.
- vii. Pitch – Black or dark brown solid cementitious residue which gradually liquefies when heated and which is produced by distilling off the volatile constituents from tar.

**Specifications for Road Tars:**

Indian Standards classify road tars for paving purposes into five grades — RT1, RT2, RT3, RT4, and RT5, meant for specific purposes.

These are covered by “IS: 215-1995: Road tar: Specifications, Bureau of Indian Standards, New Delhi, 2000”.

**The grades and specific uses are given below in Table 6.12:**

**Table 6.12 (IS: 215-1995, 2000)**

Grade	Specific uses
RT-1	Surface dressing for very cold weather conditions and at very high elevation on hill roads.
RT-2	Surface dressing under normal climatic conditions.
RT-3	(a) Surface dressing and renewal coats. (b) Pre-coating chippings; light chipping carpet.
RT-4	Premix tar macadam
RT-5	Grouting

### **Low Temperature Tar:**

The coal-tar produced in the manufacture of coking coal requires carbonation at high temperatures above 1000°C. In view of the increasing demand for road tars in recent years, a new technology known as low temperature carbonisation has come into vogue.

In this, the carbonisation of coal is carried out in the temperature range of 600°-750°C in a smokeless fuel process. The crude tar thus produced is successfully used for making road tars; these are known as low temperature tars.

### **Bitumen versus Tar:**

**A comparison of bitumen and tar is given below:**

- I. Aggregates coated with tar exhibit lower stripping action than those coated with bitumen.
- II. Tar is more susceptible to temperature than bitumen. It becomes liquid at relatively lower temperature.
- III. Tar is not easily dissolved in petroleum solvents; so it can be preferred for paving parking areas, where oils might drip from vehicles.
- IV. Since more setting time is required for tar, it may be processed at a mixing plant and carried to the construction site.
- V. In view of the higher free carbon content, tar is more brittle than bitumen.
- VI. As tars have more phenol content, they can get more easily oxidised than bitumen.
- VII. At higher temperatures, tar may be more easily affected than bitumen.
- VIII. As more time is required for tar to set, tar-paved roads need to be closed to traffic for a longer time.

IX. Both bitumen and tar appear black in colour in a large mass, but appear brown in thin films.

**Tar-Bitumen Mixtures:**

A mixture of tar and bitumen provides a binder of excellent quality as it has a decreased volume of insoluble benzene is decreased. Such mixtures have lower temperature susceptibility and reduced penetration value. Rheological properties of the binder also get altered. Generally, a mixture of tar and bitumen in equal proportions is considered to be an ideal binder.

**Bituminous Mixes:**

Bituminous mixes for paving purposes consist of coarse aggregate, fine aggregate, filler material, bitumen, and air voids, suitably proportional and blended to provide a strong, stable and durable pavement.

The main aim of mix design is to determine the optimum bitumen content that will hold the mineral aggregates of suitable gradation together as a compact layer that resists the traffic loads. The mix should have a certain minimum air voids to allow volume changes during service either because of temperature changes or repeated loading from the traffic.

**Requirements of Bituminous Mixes:**

**The following are the important requirements of bituminous mixes for pavements:**

**(i) Stability:**

This is the resistance to deformation under traffic loads; it is a function of inter-particle friction and cohesion offered by the bitumen binder. It is related to the density of the mix which is dependent on the voids content. The more the density, the more stable the mix; however, a minimum voids content is necessary to allow for volume changes which cannot be fully prevented.

**(ii) Durability:**

This is the resistance to weathering action and abrasion from traffic. Spalling, stripping and formation of pits, corrugations and potholes can result from weathering and traffic. Excessive strain may cause cracking or plastic failure.

**(iii) Flexibility:**

This is a measure of the resistance to long-term deformations and shapes of the road base, sub-base and subgrade; this depends on the flexural or bending strength of the pavement.

**(iv) Skid Resistance:**

The resistance of the surface of the pavement laid with the bituminous mix to skidding of the tyres of vehicles is called skid resistance. The surface texture

should be such as to provide grip or friction even under wet conditions. This is important in the prevention of accidents.

**(v) Workability:**

This is the ease with which the mix can be placed in position and compacted. It depends on the aggregate characteristics like the size, shape texture and gradation, bitumen content and nature of the bituminous material.

**(vi) Economy:**

The overall cost in achieving the desired qualities of the mix and the pavement should be a minimum, consistent with quality.

**The desired qualities of the bituminous mixes, therefore, have to be achieved by:**

1. Using good quality aggregate, which is hydrophobic and has rough surface texture, with appropriate grading and voids content.
2. Using bituminous binder of the correct quality and consistency based on the specific purpose for which the pairing mix is intended.
3. Controlling the voids content and the bitumen content to achieve the desirable qualities listed above.

**4. Cement, Cement Mortar and Cement Concrete:**

Cement concrete is a versatile material which has revolutionised civil engineering construction during the twentieth century. A fresh cement concrete mix consists of cement, mineral aggregates (coarse aggregate and fine aggregate), and water.

A well-designed cement concrete mix sets and hardens due to the binding property of the cements, forms a mix with minimum void space and on curing with water, provides a strong, stable and durable pavement for a highway, resisting repetitive impact from wheel loads and also withstanding adverse environmental conditions.

Thus, a cement concrete pavement is the most superior highway construction primarily from the point of view of strength and durability. The ingredients of the concrete mix, viz., the coarse aggregate (broken stone) and fine aggregate (sand) have to be selected carefully to satisfy the desirable properties for concrete-making. Potable water is generally considered satisfactory making cement concrete.

Cement is used also as an additive to soil to produce soil-cement used as the primarily material in the construction of low-cost roads.

**Cement:**

Cement is the most important ingredient of cement concrete or cement mortar (cement mortar is a suitable mixture of cement and fine aggregate or sand in appropriate proportions).

Cement mixed with water becomes a paste and spreads over the aggregates forming a thin film; chemical reactions take place leading to the formation of silicates and aluminates. Subsequently, setting takes place and in the presence of water, hydration takes place leading to hardening of the concrete.

The most common cement is what is now known as the Ordinary Portland Cement (OPC). Calcareous and silicate compounds are blended and heated to high temperatures (1500°C) to form clinkers of new chemical compounds, which when ground to fine particles result in 'cement'.

**The primary ingredients of cement are:**

- (i) Tricalcium silicate ( $3\text{CaO}\cdot\text{SiO}_2$ )  $\approx$  50%
- (ii) Dicalcium silicate ( $2\text{CaO}\cdot\text{SiO}_2$ )  $\approx$  22%
- (iii) Tricalcium aluminate ( $3\text{CaO}\cdot\text{Al}_2\text{O}_3$ )  $\approx$  9%
- (iv) Tetracalcium aluminoferrite ( $4\text{CaO}\cdot\text{Al}_2\text{O}_3\cdot\text{Fe}_2\text{O}_3$ )  $\approx$  9%
- (v) Miscellaneous compounds  $\approx$  10%

The silicates contribute to the immediate strength gain while the other ingredients are responsible for the long-term strength gain. The properties of cement can be modified by blending it in different admixtures in the manufacturing process.

**The following are the different types cements widely used for specific purposes in India:**

- i. Ordinary Portland cement (OPC)
- ii. Rapid hardening cement
- iii. High alumina cement
- iv. Low heat cement
- v. Portland blast furnace slag cement
- vi. White cement

**Function of soil as highway Subgrade**

Soil is used for the construction of the bottom most layer of the pavement, i.e. sub-grade. Here is a short details of the sub-grade and its function.:

- Sub-grade is the layer of the pavement whose main function is to support the upper layers of the pavement and to provide the good drainage facility to the infiltrating rain water. It has to act as a single structure along with other layers of the pavement.

- Soil is compacted to its maximum dry density which can be achieved by using the optimum moisture content and the methods of compaction control. Strength has to be ensured which is required for the given design thickness of the pavement.
- Strength analysis and the thickness of pavement are inter linked because more thickness of the pavement is needed if the soil is weak but if the soil possess a good strength then less thickness is needed.

This is ensured by using the CBR (California Bearing Ratio) Test which is produced or was first used by the California State Highway Department. Using the CBR test and the empirical charts you can find out the thickness of the flexible pavement required above the sub-grade.

### **Tests on soil**

Sub grade soil is an integral part of the road pavement structure as it provides the support to the pavement from beneath. The sub grade soil and its properties are important in the design of pavement structure. The main function of the sub grade is to give adequate support to the pavement and for this the sub grade should possess sufficient stability under adverse climatic and loading conditions. Therefore, it is very essential to evaluate the sub grade by conducting tests.

The tests used to evaluate the strength properties of soils may be broadly divided into three groups:

- Shear tests
- Bearing tests
- Penetration tests

Shear tests are usually carried out on relatively small soil samples in the laboratory. In order to find out the strength properties of soil, a number of representative samples from different locations are tested. Some of the commonly known shear tests are direct shear test, triaxial compression test, and unconfined compression test.

Bearing tests are loading tests carried out on sub grade soils in-situ with a load bearing area. The results of the bearing tests are influenced by variations in the soil properties within the stressed soil mass underneath and hence the overall stability of the part of the soil mass stressed could be studied.

Penetration tests may be considered as small scale bearing tests in which the size of the loaded area is relatively much smaller and ratio of the penetration to

the size of the loaded area is much greater than the ratios in bearing tests. The penetration tests are carried out in the field or in the laboratory.

### **California Bearing Ratio: methods of finding CBR valued in the laboratory and at site and their significance**

#### **California Bearing Ratio Test**

California Bearing Ratio (CBR) test was developed by the California Division of Highway as a method of classifying and evaluating soil-sub grade and base course materials for flexible pavements. CBR test, an empirical test, has been used to determine the material properties for pavement design. Empirical tests measure the strength of the material and are not a true representation of the resilient modulus. It is a penetration test wherein a standard piston, having an area of 3 in (or 50 mm diameter), is used to penetrate the soil at a standard rate of 1.25 mm/minute. The pressure up to a penetration of 12.5 mm and it's ratio to the bearing value of a standard crushed rock is termed as the CBR.

In most cases, CBR decreases as the penetration increases. The ratio at 2.5 mm penetration is used as the CBR. In some case, the ratio at 5 mm may be greater than that at 2.5 mm. If this occurs, the ratio at 5 mm should be used. The CBR is a measure of resistance of a material to penetration of standard plunger under controlled density and moisture conditions. The test procedure should be strictly adhered if high degree of reproducibility is desired. The CBR test may be conducted in re-moulded or undisturbed specimen in the laboratory. The test is simple and has been extensively investigated for field correlations of flexible pavement thickness requirement.

#### **Test Procedure**

- The laboratory CBR apparatus consists of a mould 150 mm diameter with a base plate and a collar, a loading frame and dial gauges for measuring the penetration values and the expansion on soaking.
- The specimen in the mould is soaked in water for four days and the swelling and water absorption values are noted. The surcharge weight is placed on the top of the specimen in the mould and the assembly is placed under the plunger of the loading frame.
- Load is applied on the sample by a standard plunger with dia of 50 mm at the rate of 1.25 mm/min. A load penetration curve is drawn. The load values on standard crushed stones are 1370 kg and 2055 kg at 2.5 mm and 5.0 mm penetrations respectively.



- CBR value is expressed as a percentage of the actual load causing the penetrations of 2.5 mm or 5.0 mm to the standard loads mentioned above. Therefore,

$$CBR = \frac{\text{load carries by specimen}}{\text{load carries by standard specimen}} \times 100$$

Two values of CBR will be obtained. If the value of 2.5 mm is greater than that of 5.0 mm penetration, the former is adopted. If the CBR value obtained from test at 5.0 mm penetration is higher than that at 2.5 mm, then the test is to be repeated for checking. If the check test again gives similar results, then higher value obtained at 5.0 mm penetration is reported as the CBR value. The average CBR value of three test specimens is reported as the CBR value of the sample.

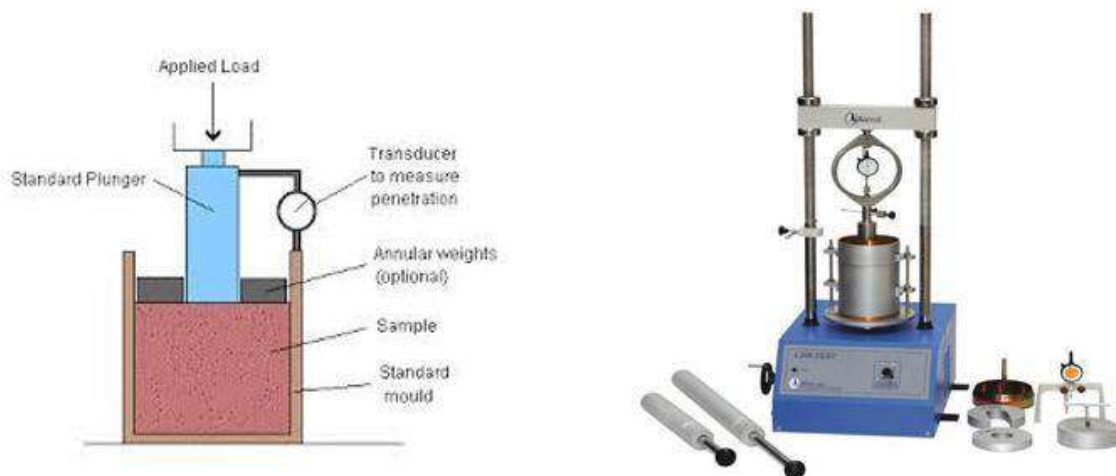

Fig.CBR Testing machine

**Testing aggregates: Abrasion test, impact test, crushing strength test, water absorption test & soundness test**

**Abrasion test:**

Due to the movement of traffic, the road stones used in the surfacing course are subjected to wearing action at the top. Resistance to wear or hardness is hence an essential property for road aggregates especially when used in wearing course. Thus road stones should be hard enough to resist the abrasion due to the traffic.

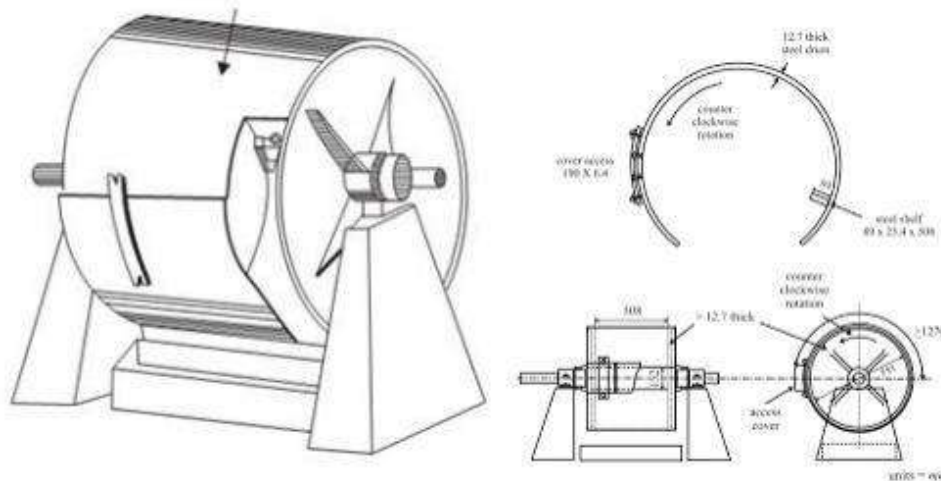

Fig. Los Angles Abrasion Machine

### Testing Procedure:

- 1) Take the clean and dried aggregates in an oven at 105-110° C.
- 2) Sieve the given aggregates in sieve size 20-12.5mm and weigh that aggregate in 2.5kg.
- 3) Again sieve the aggregate in sieve size is 12.5-10mm and take that aggregates in 2.5 k. i.e., W1 gm (2.5+2.5=5kg)
- 4) Pour the given taking aggregates into the los angles abrasion machine.
- 5) Put the steel balls into the abrasion machine after pouring the aggregates.
- 6) Start the machine and rotating the drum for 100 revolutions and stop the machine.
- 7) After stopping the machine, take out the aggregates and sieve the aggregates in 1.7mm sieve size and take the retained aggregates and note down its weight i.e, W2 gm.
- 8) Then, Los Angles Abrasion value=  $(W1-W2/W1) \times 100 \%$

### Impact test:

Toughness is the property of a material to resist impact. Due to traffic loads the road stones are subjected to the pounding action or impact and there is possibility of stones breaking into smaller pieces. The road stones should therefore be tough enough to resist fracture under impact. A test designed to evaluate the toughness of stones i.e. the resistance of the stones to fracture under repeated impacts may be an impact test for road aggregate.

The aggregate impact value indicates a relative measure of the resistance of an aggregate to a sudden shock or an impact, which in some aggregate differs from its resistance to a slow compressive load. The method of tests specifies the

procedure for determining the aggregate impact value of coarse aggregate.

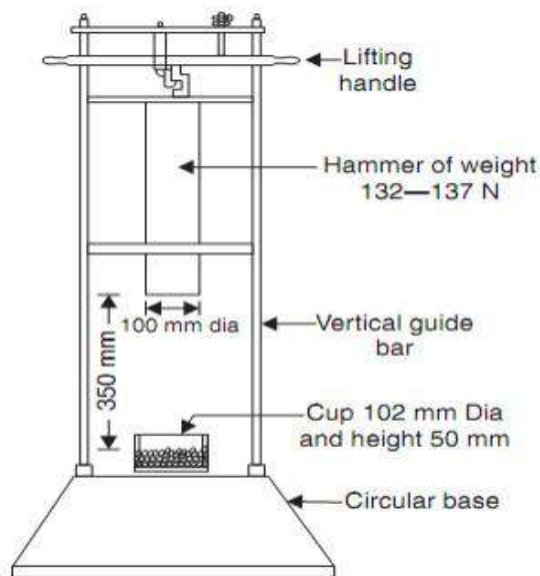

Fig. Impact test Machine

### Testing Procedure:

- i. Take clean and dry aggregate and sieve on IS 12.5 mm and 10.00 mm sieve.
- ii. Collect the aggregate passing IS 12.5mm sieve and retained on IS 10.0 mm Sieve.
- iii. Find the weight of empty cylindrical measure. Let the weight be 'a' g.
- iv. Fill the aggregate in the cylindrical measure in three layers, tamping each layer 25 times with the rounded end of the tamping rod.
- v. Roll the tamping rod over aggregate surface and remove excess aggregate, if any.
- vi. Find the weight of the cylindrical measure with aggregate. Let the weight be 'b' g. Thus the weight of aggregate =  $W_1 = (b - a)$
- vii. Transfer all the aggregate from the cylindrical measure to the test cylinder in one layer and tamp the layer 25 times with the rounded end of the tamping rod.
- viii. Fix the test cylinder firmly to the base of the impact tester.
- ix. Adjust the height of fall of the plunger to  $380 \pm 5$  mm and set the blow counter to zero.
- x. Lift the plunger gently and allow it to drop. This is one blow. Give 15 such blows.
- xi. Take out the test cylinder and sieve the crushed material on IS 2.36 mm sieve. Find the weight of material passing the sieve. Let weight be  $W_2$  g.
- xii. Find the weight of aggregate retained on this sieve. Let the weight be  $W_3$  g. Then,

$$\text{Aggregate impact value} = \frac{W_2}{W_1} * 100 \%$$

And percentage of dust =  $W3 / W1 * 100 \%$

### Crushing strength test

The Principal mechanical properties required in road stones are (i) Satisfactory resistance to crushing under the roller during construction and (ii) adequate resistance to surface abrasion under traffic. Also stresses under rigid tyre rims of heavily loaded animal drawn vehicles are high enough to consider the crushing strength of road aggregate as an essential requirement in India. Crushing strength of road aggregate may be determined either on aggregate or on cylindrical specimens cut out of rocks. These two tests are quite different is not only the approach but also is the expression of the results.

Aggregate used in road construction, should be strong enough to resist crushing under traffic wheel loads. If the aggregate are weak, the stability of the pavement stretches is likely to be adversely affected, the strength of coarse aggregate is assessed by aggregate crushing test. The aggregate crushing value provides a relative measure of resistance to crushing under gradually applied compressive load. To achieve a high quality of pavement, aggregate possessing low aggregate value should be preferred.

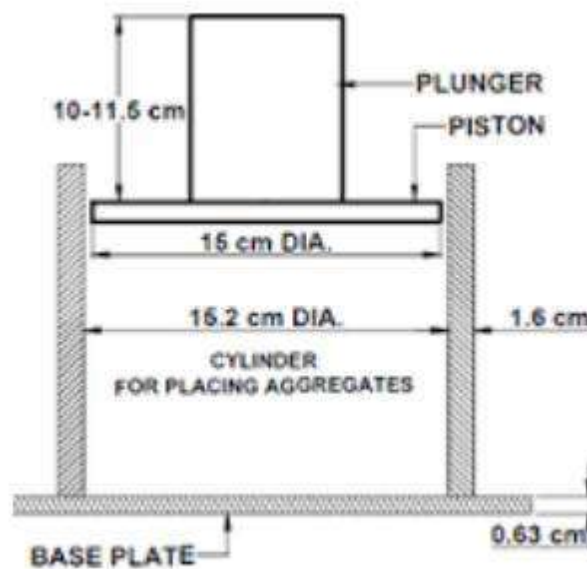

Fig. Arrangement of Crushing strength test

### Testing Procedure:

- i. Select clean and dry aggregate passing through IS 12.5 mm and retained on IS 10.0 mm sieve.
- ii. Weight the empty cylindrical measure. Let the weight be 'a' g
- iii. Fill the aggregate in the cylindrical measure in three layers, tamping each layer 25 times with the rounded end of the tamping rod. Weigh the cylindrical measure with aggregate. Let the weight be 'b' grams. Thus the weight of aggregate =  $W_1$  g
- iv. Transfer the aggregate into the steel cylinder again in three layers tamping each layer 25 times

- v. Place the plunger in the steel cylinder such that the piston rests horizontally over the aggregate surface.
- vi. Keep the assembly of steel cylinder with plunger in the compression testing machine.
- vii. Set the pointer to read zero and apply the compressive load of 40 tonnes.
- viii. Stop the machine. Take out the assembly.
- ix. Sieve the crushed material on IS 2.36 mm sieve and find the weight of material passing this sieve. Let the weight be  $W_2$  g.
- x. Then Aggregate crushing value =  $W_2 / W_1 * 100 \%$

### Specific Gravity and Water Absorption Test on Aggregates

The specific gravity of an aggregate is considered to be a measure of strength or quality of the material. Stones having low specific gravity are generally weaker than those with higher specific gravity values. The specific gravity test helps in the identification of stone.

Water absorption gives an idea of strength of rock stones having more water absorption are more porous in nature and are generally considered unsuitable unless they are found to be acceptable based on strength, impact and hardness.

#### Testing Procedure :

1. Take about 2kg of given aggregates passing IS 20mm sieve and retained on 10mm sieve.
2. Keep the aggregate in density basket and then keep the basket in water.
3. Allow the aggregate and basket to be in water for 24 hours.
4. After 24 hours find the suspended weight of basket with aggregate.
5. Remove the basket out of water and remove the aggregate.
6. Keep the empty basket back in water and find the suspended weight.
7. Wipe the surface of aggregate using a cotton cloth to make them surface dry.
8. Find the weight of surface dry aggregate in air.
9. Keep the aggregate in oven at  $110^\circ \text{C}$  for 24 hours.
10. Now find the weight of dried aggregate in air.
11. Then specific gravity and Water absorption is calculated from the relation:

$$\text{Specific gravity} = \frac{W_4}{W_3 - (W_1 - W_2)}$$

$$\text{Water absorption} = \frac{W_3 - W_4}{W_4} * 100 \%$$

### **Soundness test**

To study the resistance of aggregates to weathering action, by conducting accelerated weathering test cycle.

#### **Testing Procedure**

1. In order, to quicken the effects of weathering due to alternate wet-dry or freeze-thaw cycles in the laboratory, the resistance to disintegration of aggregate is determined by using saturated solution of sodium sulphate or magnesium sulphate.
2. Clean, dry aggregates of specified size is weighed and counted. Then immersed in the saturated solution of sodium sulphate or magnesium sulphate for 16 to 18 hours.
3. Then the aggregates are dried in an oven at 105-110°C to a constant weight, thus making one cycle of immersion and drying.
4. The number of such cycles is decided by prior agreement and then the specimens are tested. After completing the final cycle, the sample is dried and each fraction of aggregate is examined visually to see if there is any evidence of excessive splitting, crumbling or disintegration of the grains.
5. Sieve analysis is carried out to note the variation in gradation from original. The coarse aggregate fraction of each size range is sieved on specified sieve sizes.

#### **Desirable value**

IRC has specified 12percent as the maximum permissible loss in soundness test after 5 cycles with sodium sulphate, for the aggregate to be used in bituminous surface dressing, penetration macadam and bituminous macadam constructions.

## **ROAD PAVEMENTS**

**Road Pavement: Flexible and rigid pavement, their merits and demerits, typical cross-sections, functions of various components :**

### **Introduction:**

A highway pavement is a structure consisting of superimposed layers of processed materials above the natural soil sub-grade, whose primary function is to distribute the applied vehicle loads to the sub-grade. The pavement structure should be able to provide a surface of acceptable riding quality, adequate skid resistance, favorable light reflecting characteristics, and low noise pollution. The ultimate aim is to ensure that the transmitted stresses due to wheel load are sufficiently reduced, so that they will not exceed bearing capacity of the sub-grade. Two types of pavements are generally recognized as serving this



purpose, namely flexible pavements and rigid pavements. This chapter gives an overview of pavement types, layers, and their functions, and pavement failures. Improper design of pavements leads to early failure of pavements affecting the riding quality.

### **Requirements of a pavement**

An ideal pavement should meet the following requirements:

- Sufficient thickness to distribute the wheel load stresses to a safe value on the sub-grade soil,
- Structurally strong to withstand all types of stresses imposed upon it,
- Adequate coefficient of friction to prevent skidding of vehicles,
- Smooth surface to provide comfort to road users even at high speed,
- Produce least noise from moving vehicles,
- Dust proof surface so that traffic safety is not impaired by reducing visibility,
- Impervious surface, so that sub-grade soil is well protected, and
- Long design life with low maintenance cost.

### **Types of pavements**

The pavements can be classified based on the structural performance into two, flexible pavements and rigid pavements. In flexible pavements, wheel loads are transferred by grain-to-grain contact of the aggregate through the granular structure. The flexible pavement, having less flexural strength, acts like a flexible sheet (e.g. bituminous road). On the contrary, in rigid pavements, wheel loads are transferred to sub-grade soil by flexural strength of the pavement and the pavement acts like a rigid plate (e.g. cement concrete roads). In addition to these, composite pavements are also available. A thin layer of flexible pavement over rigid pavement is an ideal pavement with most desirable characteristics. However, such pavements are rarely used in new construction because of high cost and complex analysis required.

### **Flexible pavements**

Flexible pavements will transmit wheel load stresses to the lower layers by grain-to-grain transfer through the points of contact in the granular structure (see Figure ).

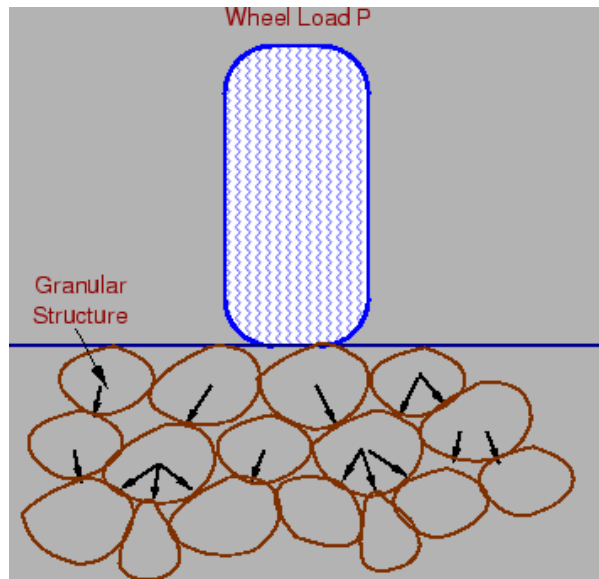

**Figure 1 :** Load transfer in granular structure

The wheel load acting on the pavement will be distributed to a wider area, and the stress decreases with the depth. Taking advantage of this stress distribution characteristic, flexible pavements normally has many layers. Hence, the design of flexible pavement uses the concept of layered system. Based on this, flexible pavement may be constructed in a number of layers and the top layer has to be of best quality to sustain maximum compressive stress, in addition to wear and tear. The lower layers will experience lesser magnitude of stress and low quality material can be used. Flexible pavements are constructed using bituminous materials. These can be either in the form of surface treatments (such as bituminous surface treatments generally found on low volume roads) or, asphalt concrete surface courses (generally used on high volume roads such as national highways). Flexible pavement layers reflect the deformation of the lower layers on to the surface layer (e.g., if there is any undulation in sub-grade then it will be transferred to the surface layer). In the case of flexible pavement, the design is based on overall performance of flexible pavement, and the stresses produced should be kept well below the allowable stresses of each pavement layer.

### **Types of Flexible Pavements**

The following types of construction have been used in flexible pavement:

- Conventional layered flexible pavement,
- Full - depth asphalt pavement, and
- Contained rock asphalt mat (CRAM).

**Conventional flexible pavements** are layered systems with high quality expensive materials are placed in the top where stresses are high, and low quality cheap materials are placed in lower layers.

**Full - depth asphalt pavements** are constructed by placing bituminous layers directly on the soil sub-grade. This is more suitable when there is high traffic and local materials are not available.

**Contained rock asphalt mats** are constructed by placing dense/open graded aggregate layers in between two asphalt layers. Modified dense graded asphalt concrete is placed above the sub-grade will significantly reduce the vertical compressive strain on soil sub-grade and protect from surface water.

### Typical layers of a flexible pavement

Typical layers of a conventional flexible pavement includes seal coat, surface course, tack coat, binder course, prime coat, base course, sub-base course, compacted sub-grade, and natural sub-grade (Figure 2).

#### *Seal Coat:*

Seal coat is a thin surface treatment used to water-proof the surface and to provide skid resistance.

#### *Tack Coat:*

Tack coat is a very light application of asphalt, usually asphalt emulsion diluted with water. It provides proper bonding between two layer of binder course and must be thin, uniformly cover the entire surface, and set very fast.

#### *Prime Coat:*

Prime coat is an application of low viscous cutback bitumen to an absorbent surface like granular bases on which binder layer is placed. It provides bonding between two layers. Unlike tack coat, prime coat penetrates into the layer below, plugs the voids, and forms a water tight surface.

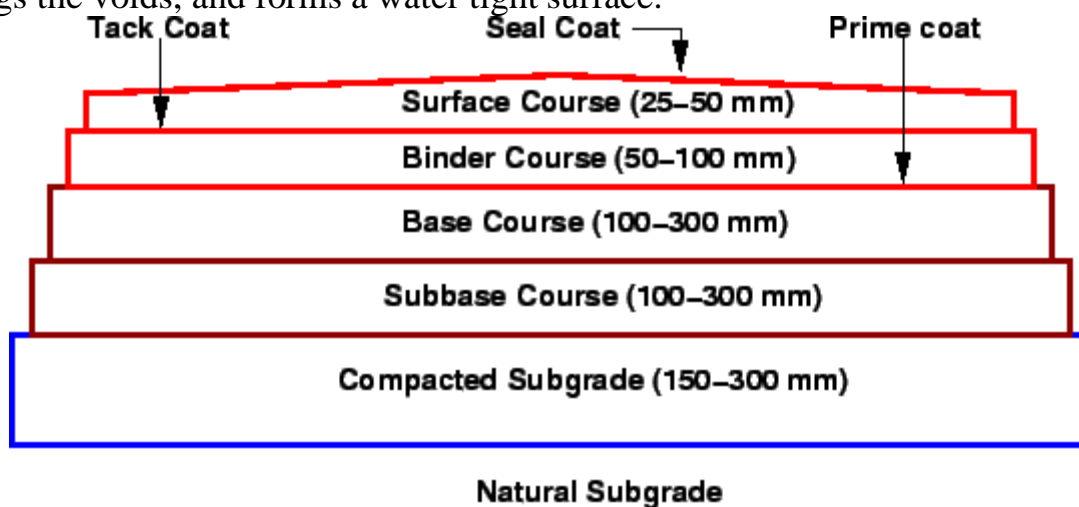

**Figure2 :** Typical cross section of a flexible pavement

### **Surface course**

Surface course is the layer directly in contact with traffic loads and generally contains superior quality materials. They are usually constructed with dense graded asphalt concrete (AC). The functions and requirements of this layer are:

- It provides characteristics such as friction, smoothness, drainage, etc. Also it will prevent the entrance of excessive quantities of surface water into the underlying base, sub-base and sub-grade,
- It must be tough to resist the distortion under traffic and provide a smooth and skid- resistant riding surface,
- It must be water proof to protect the entire base and sub-grade from the weakening effect of water.

### **Binder course**

This layer provides the bulk of the asphalt concrete structure. Its chief purpose is to distribute load to the base course. The binder course generally consists of aggregates having less asphalt and doesn't require quality as high as the surface course, so replacing a part of the surface course by the binder course results in more economical design.

### **Base course**

The base course is the layer of material immediately beneath the surface of binder course and it provides additional load distribution and contributes to the sub-surface drainage. It may be composed of crushed stone, crushed slag, and other untreated or stabilized materials.

### **Sub-Base course**

The sub-base course is the layer of material beneath the base course and the primary functions are to provide structural support, improve drainage, and reduce the intrusion of fines from the sub-grade in the pavement structure. If the base course is open graded, then the sub-base course with more fines can serve as a filler between sub-grade and the base course. A sub-base course is not always needed or used. For example, a pavement constructed over a high quality, stiff sub-grade may not need the additional features offered by a sub- base course. In such situations, sub-base course may not be provided.

### **Sub-grade**

The top soil or sub-grade is a layer of natural soil prepared to receive the stresses from the layers above. It is essential that at no time soil sub-grade is

overstressed. It should be compacted to the desirable density, near the optimum moisture content.

### Failure of flexible pavements

The major flexible pavement failures are fatigue cracking, rutting, and thermal cracking. The fatigue cracking of flexible pavement is due to horizontal tensile strain at the bottom of the asphaltic concrete. The failure criterion relates allowable number of load repetitions to tensile strain and this relation can be determined in the laboratory *fatigue test* on asphaltic concrete specimens. Rutting occurs only on flexible pavements as indicated by permanent deformation or rut depth along wheel load path. Two design methods have been used to control rutting: one to limit the vertical compressive strain on the top of subgrade and other to limit rutting to a tolerable amount (12 mm normally). Thermal cracking includes both low-temperature cracking and thermal fatigue cracking.

### Rigid pavements

Rigid pavements have sufficient flexural strength to transmit the wheel load stresses to a wider area below. A typical cross section of the rigid pavement is shown in Figure 3. Compared to flexible pavement, rigid pavements are placed either directly on the prepared sub-grade or on a single layer of granular or stabilized material. Since there is only one layer of material between the concrete and the sub-grade, this layer can be called as base or sub-base course.

Rigid Pavement Typical Cross Section

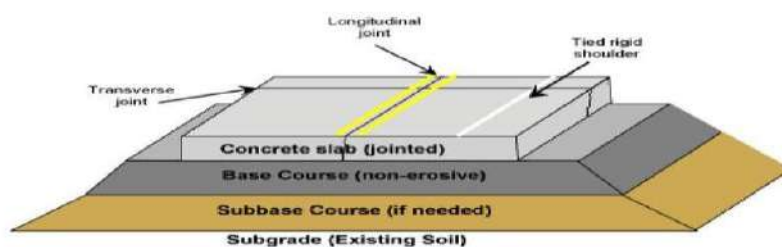
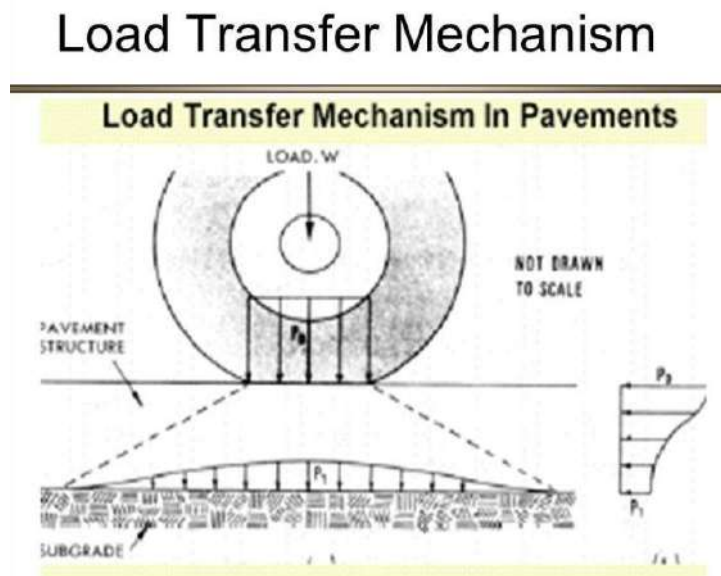

Figure 3: Typical Cross section of Rigid pavement

In rigid pavement, load is distributed by the slab action, and the pavement behaves like an elastic plate resting on a viscous medium. Rigid pavements are constructed by Portland cement concrete (PCC) and should be analyzed by plate theory instead of layer theory, assuming an elastic plate resting on viscous foundation. Plate theory is a simplified version of layer theory that assumes the

concrete slab as a medium thick plate which is plane before loading and to remain plane after loading. Bending of the slab due to wheel load and temperature variation and the resulting tensile and flexural stress.



**Figure 4 :** Load transfer in rigid pavement

### Types of Rigid Pavements

Rigid pavements can be classified into four types:

- Jointed plain concrete pavement (JPCP),
- Jointed reinforced concrete pavement (JRCP),
- Continuous reinforced concrete pavement (CRCP), and
- Pre-stressed concrete pavement (PCP).

#### **Jointed Plain Concrete Pavement:**

are plain cement concrete pavements constructed with closely spaced contraction joints. Dowel bars or aggregate interlocks are normally used for load transfer across joints. They normally has a joint spacing of 5 to 10m.

#### **Jointed Reinforced Concrete Pavement:**

Although reinforcements do not improve the structural capacity significantly, they can drastically increase the joint spacing to 10 to 30m. Dowel bars are required for load transfer. Reinforcements help to keep the slab together even after cracks.

#### **Continuous Reinforced Concrete Pavement:**

Complete elimination of joints are achieved by reinforcement.

## Failure criteria of rigid pavements

Traditionally fatigue cracking has been considered as the major, or only criterion for rigid pavement design. The allowable number of load repetitions to cause fatigue cracking depends on the stress ratio between flexural tensile stress and concrete modulus of rupture. Of late, pumping is identified as an important failure criterion. Pumping is the ejection of soil slurry through the joints and cracks of cement concrete pavement, caused during the downward movement of slab under the heavy wheel loads. Other major types of distress in rigid pavements include faulting, spalling, and deterioration.

### Components of rigid pavement and there Functions:

1. Prepared soil subgrade.
2. Granular sub-base (GSB) or drainage layer.
3. Base course/ (DLC-Dry lean concrete).
4. CC pavement slab using PQC (paving quality concrete).

#### 1. Prepared soil subgrade:

- ❖ The soil subgrade of rigid pavement consist of natural or selected soil from identified borrow pits fulfilling the specified requirements.
- ❖ The soil subgrade is well compacted to the desired density and to the required thickness.
- ❖ The soil subgrade is the lower most layer of the pavement structure which ultimately supports all other pavement layer and traffic loads.
- ❖ A good soil subgrade / well compacted and prepared soil subgrade gives long service life to the pavement.

#### 2. Granular sub-base (GSB) or drainage layer:

- ❖ The GSB course has to serve as an effective drainage layer of the rigid pavement to prevent early failures due to excessive moisture content in the subgrade soil.
- ❖ Crushed stone aggregate are preferred In the granular subbase course as this material has high permeability and serves as a effective drainage layer.
- ❖ Coarse graded aggregates with low percent of fines (<5% finer than 75 micron sieve) will serve as good drainage layer.
- ❖ An effective drainage layer under the CC pavements have the following benefits:
  - a. Increases in service life and improved performance of CC pavements.
  - b. Prevention of early failures of the rigid pavements due to pumping and blowing.
  - c. Protection of the subgrade against frost action in the frost susceptible areas.

#### 3. Base course: ( Dry lean concrete):

- ❖ The granular base course is generally provided under the CC pavement slab in low volume roads and also in roads with moderate traffic loads.
- ❖ On roads carrying heavy to very heavy traffic loads high quality base course materials such as dry lean concrete are preferred.
- ❖ In the base course of the CC pavement as they are designed for a life of 30 years or more with good maintenance. The CC pavement are expressed to provide a service life of 40 years or even more.
- ❖ The DLC layer provides a uniform support, high K value and excellent working platform for laying the PQC slab with a sensor paver.
- ❖ The suppression member is spread on the top of the DLC/ base course before laying the CC pavement slab.

#### **4.CC pavement slab: (paving quality concrete (PQC):**

- ❖ M-40 cement concrete mix with a minimum flexural strength of 45 kg/cm<sup>2</sup> is recommended by the IRC for use in the CC-pavements of highways with heavy to very heavy traffic loads.
- ❖ The C pavement slab is extended to with stand the flexural stress caused by the heavy traffic loads and the warping effects in the CC pavements due to the temperature variations.
- ❖ The high quality CC mix with high flexural strength is used for the construction of PQC slab of the CC pavement.
- ❖ The CC pavement slab as considerable flexural strength and spreads the applied load/ wheel loads over a large area by slab action.
- ❖ The slab prevents the infiltration of excess surface water in to the sub-base.

### **Sub-grade preparation**

**Setting out alignment of road, setting out bench marks, control pegs for embankment and cutting, borrow pits, making profile of embankment, construction of embankment, compaction, stabilization, preparation of subgrade, methods of checking camber, gradient and alignment as per recommendations of IRC, equipment used for subgrade preparation**

This work shall consist of the preparation of subgrade in embankment, or in cut by scarifying, watering, compacting and shaping existing or previously placed material in accordance with these Specifications and to the lines, levels, grades, dimensions and cross sections shown on the Drawings or as required by the Engineer.

### **Materials**



All subgrade material shall be from sources, which the contractor shall propose and which shall be approved by the Engineer. The material shall be free from roots, sods or other deleterious material and when compacted to 98% of maximum dry density determined in accordance with STP 4.3 shall have a 4 day soaked CBR value of not less than 5%. Subgrade material shall satisfy the following criteria: · Liquid limit of soil fraction passing 0.425 mm sieve not to exceed 50% (STP 3.2) · Plasticity index of soil fraction passing 0.425 mm sieve not to exceed 15% (STP 3.2) Any subgrade material in cut or existing old embankment, which is found to be unsuitable, shall be removed and replaced as directed by the Engineer.

### **Construction Methods**

The subgrade shall be prepared over the full width of the embankment including shoulders. Part width working may be allowed with the prior written approval of the Engineer. The subgrade shall be prepared in lengths of not less than 100 metres at any one time, unless otherwise approved by the Engineer. Subgrade material shall be scarified to a depth of 150 mm until the soil is fully loosened. Any lumps or clods shall be removed or broken to pass a 50 mm sieve. If the Drawings require the subgrade to be compacted for a depth greater than 150 mm, the work shall be carried out in more than one layer, the material in the upper layer being first removed in the case of road sections in cut. The moisture content of the sub-grade material before compaction shall be within  $\pm 2\%$  of the predetermined optimum moisture content established in accordance with STP 4.3 (Standard Compaction). The achieved dry density after compaction of the subgrade layer shall not be less than 98% of maximum dry density as determined in accordance with STP 4.3. When necessary, each layer, before being compacted, shall be allowed to dry or be watered to bring the moisture content to within  $\pm 2\%$  of optimum to make possible its compaction to the required dry density. The material shall be so worked as to have a uniform moisture content through the entire layer. The subgrade material shall be compacted uniformly by use of adequate and appropriate compaction equipment. The compaction shall be done in a longitudinal direction along the embankment and shall generally begin at the outer edges and progress toward the centre in such a manner that each section receives equal compactive effort.

Samples to determine the compaction shall be taken regularly with a set of three samples for each 1,000 square metres of finished layer or as decided by the Engineer will be carried out according to STP 6.2. If the test results show that the density is less than the required dry density, the Contractor shall carry out further compaction to obtain at least the required dry density. The compacted subgrade layer shall be approved by the Engineer before the Contractor can commence a new layer.

The surface of the finished subgrade shall be neat and workmanlike and have the required form, super elevation, levels, grades and cross section. The

finished surface shall be constructed with a tolerance of 20 mm above or below the specified levels at any point.

### **Sub base Course:**

#### **Necessity of sub base, stabilized sub base, purpose of stabilization (no designs)**

A subgrade/sub base is made up of native soil that has been compacted to withstand the loads above it. It is a layer required in many structures such as pavements and slabs, although it needs to have certain characteristics. A subgrade might need special drainage structures to let water if it is composed of impermeable soil, and it should be graded to within plus or minus 1.5 inches of the specified elevation.

There is no consistency in regards to the terms of subbase and subgrade, but normally the subgrade is the native soil while the subbase is the layer of soil or aggregate on top of the subgrade.

#### **Necessity of sub base**

- ❖ The need for a subbase - a layer of granular material placed on a prepared subgrade - depends on the frequency of heavy truck loadings. While mandatory for major highways, a subbase is seldom required for light- duty concrete pavements.
- ❖ Performance studies and surveys have shown the conditions for which a subbase is or is not required. With this information, an engineer can analyze these conditions and rationally decide if a subbase layer is essential.
- ❖ The function of a subbase is to help prevent pumping of fine-grained, subgrade soils. Pumping, which leads to the loss of soil material beneath slab edges and joints, occurs when three factors exist in combination: pumpable soils, excess water under the pavement, and frequent heavy truck loads.
- ❖ In the absence of heavy truck traffic, which is the case for many streets, secondary roads, and parking lots, a subbase is not needed. For these pavements, good performance can be obtained by using appropriate subgrade preparation techniques aimed at providing uniform foundation support for the pavement.

#### **Purpose of stabilization**

The purpose of a stabilized base or sub-base layer is to provide a transitional load-bearing stratum between the pavement layer, which directly receives the wheel loadings of vehicular traffic, and the underlying sub-grade soil [1]. Stabilized base or sub-base materials may be used to provide support for either flexible or rigid pavements, but are more frequently used with flexible

pavements. The key to strength development in stabilized base or sub-base mixtures is in the matrix that binds the aggregate particles together. The strength of the matrix is affected by the cementitious material used in the mixture [2]. The amount of cementitious material in a stabilized base or sub-base mix usually ranges from 5 to 10 percent by weight of the mix. The main concentration of the research is to determine various sand grain analyses and which of them is perfect for stabilization with cement to use instead of bricks or stone chips. This research also indicates the stability of the road with perfect sand cement mixing proportions.

## **MATERIALS**

The components of a stabilized base or subbase mixture include aggregate, cementitious materials, and water.

### **Aggregates**

Aggregates comprise the major portion of stabilized base. Normally, between 80 to 95 percent by weight of a stabilized base or subbase mix may consist of aggregates. A wide range of different types and gradations of aggregates have been used in stabilized base and subbase mixtures. These include conventional aggregate sources, such as crushed stone or sand and gravel, and other aggregate materials, such as blast furnace slag, recycled paving materials, and bottom ash or boiler slag from coal-fired power plants. Reclaimed pavement materials have also been successfully recycled into stabilized base and subbase mixtures, as have some marginal aggregates. Aggregates used should have the proper particle size, shape, gradation, and particle strength to contribute to a mechanically stable mixture.

### **Cementitious Materials**

The key to strength development in stabilized base or subbase mixtures is in the matrix that binds the aggregate particles together. The strength of the matrix is affected by the cementitious material used in the mixture. The amount of cementitious material in a stabilized base or subbase mix usually ranges from 5 to 10 percent by weight of the mix, but may in some cases comprise as much as up to 20 percent by weight if a lighter weight aggregate is used.

A number of different cementitious materials have been successfully used to bind or solidify the aggregate particles in stabilized base or subbase mixtures. The material that has been most frequently used is Portland cement

In some parts of the United States, mainly west of the Mississippi River, fly ash from the burning of sub-bituminous coal is widely available and, because it

exhibits self-cementing characteristics when mixed with water, it can be used by itself with no other cementitious material to bind aggregate particles together.

Coal fly ash, produced during the combustion of bituminous coal, is frequently used in stabilized base mixtures. Since this type of fly ash is a pozzolan, the mixtures in which it is used are often referred to as pozzolanic stabilized base (PSB) mixtures. Pozzolans are materials composed of amorphous siliceous or siliceous and aluminous material in a finely divided (powdery) form (similar in size to Portland cement particles) that will, in the presence of water, react with an activator to form compounds possessing cementitious properties. Pozzolan activators are alkaline materials that contain calcium and magnesium compounds present in sufficient amounts to chemically react in the presence of water with the silicate and aluminates in the pozzolan. Descriptions of various kinds of pozzolans and their specifications are provided in ASTM C618.

In PSB compositions, the fly ash is usually used in combination with either lime, Portland cement, or kiln dust, plus water, to form the matrix that cements the aggregate particles together. When used with a chemical reagent, this type of fly ash normally comprises between 10 and 20 percent by weight of a stabilized base or subbase mix. When used with lighter weight aggregates (such as coal bottom ash), the percentage of fly ash may be as high as 30 percent or more.

## **Types of stabilization**

### **Mechanical stabilization**

- ❖ In this technique mechanical energy is used (rollers, plate compactors, tampers etc. By choice or nature of soil) to improve the soil properties by compaction.
- ❖ Preferably for construction of embankment for roads, railways etc.
- ❖ Mechanical stability depends upon the degree of compaction. Normally, the compaction is done at optimum water content.

### **Uses—**

- Simplest method of soil stabilization.
- To improve the sub-grades of low bearing capacity.
- Extensively used for construction of bases, sub-bases and surfacing of roads.

### **Factors Affecting the Mechanical Stabilization**

The mechanical stability of the mixed soil depends upon the following factors.

**(1) Mechanical Strength of the Aggregate—** The mixed soil is stable if the aggregates used have high strength. However, if the mixture is properly

designed and compacted, even the aggregates of relatively low strength can provide good mechanical stability.

**(2) Mineral Composition**— the mechanical stability of the mixed soil depends upon the composition of the minerals. The minerals should be weather resistant.

**(3) Gradation**— the gradation of the mixed soil should be such that the voids of the coarser particles are filled with finer particles to obtain a high density.

**(4) Plasticity Characteristics**—

- ❖ For mud roads surfacing, highly plastic soils are used as binders. They possess greater cohesion, moisture retention capacity and provide seal against downward movement of surface water.
- ❖ For base courses, the soils should have low plasticity to avoid excessive accumulation of water and the resulting loss of strength.
- ❖ The soil available at site may seldom meet both the requirements. It is necessary to mix soils from different sources to obtain desired mix.

### **Lime stabilization**

There are basically five types of lime:

- ❖ High Calcium, quick lime (CaO)
- ❖ Hydrated, high calcium lime [Ca(OH)<sub>2</sub>]
- ❖ Dolomite lime (CaO+MgO)
- ❖ Normal, hydrated dolomitic lime [Ca(OH)<sub>2</sub>+MgO]
- ❖ Pressure, hydrated dolomitic lime [Ca(OH)<sub>2</sub>+Mg(OH)<sub>2</sub>]

- The quick lime is more effective than the hydrated lime, but the latter is more safe and convenient to handle. Generally, hydrated-lime is used. It is also known as slaked lime.
- The higher the magnesium content of the lime, the less is the affinity for water and the less is the heat generated during mixing.
- The amount of lime required varies between 2 to 10% of the soil.

Lime stabilization is done by adding lime to soil. It is useful for the stabilization of clayey soil.

- When lime reacts with soil there is exchange of cations in the absorbed water layer and a decrease in the plasticity of the soil occurs.
- The resulting material is more friable than the original clay, and is, therefore more suitable as sub-grade.

The following amount may be used as a rough guide:

- ❖ 2 to 5% for clay gravel material having less than 50% of silt-clay fraction
- ❖ 5 to 10% for soils with more than 50% of silt clay fraction
- ❖ About 10% for heavy clays used as bases and sub-bases
- ❖ For soils having particle size intermediate between (1) and (2) above, the quantity of lime required is between 3 to 7%.

Lime stabilization is not effective for sandy soils.

**Construction Method**— Construction methods used in lime stabilization are similar to those used in cement stabilization. However, the following points should be carefully noted.

- ❖ The reaction in the case of lime is slow, there is no maximum time limit between the addition of lime to the soil and the completion of compaction.
- ❖ Lime may be added in the form of slurry instead of dry powder.
- ❖ A rest period of 1 to 4 days is generally required after spreading lime over a heavy clay before final mixing is done.
- ❖ The soil-lime is compacted to the required maximum dry density.
- ❖ After compaction, the surface is kept moist for 7 days and then covered with a suitable wearing coat.

### **Cement stabilization**

- ❖ Most commonly used for road construction.
- ❖ Heavy clays are difficult to pulverize and not suitable.
- ❖ Well graded sand and gravel mixtures with upto 10% fine binder Material (passing #200 sieve).
- ❖ Quantity of cement to be determined on trial basis in lab. (minimum strength required  $3.5 \text{ N/mm}^2$ —7 days cube strength).
- ❖ Compaction to be completed within two hours after laying mixing with water.

**A. Central plant method:** faster construction, expansive, dry mix and then Wet thoroughly, spreading and compaction.

**B. Mix in place method:** similar to agriculture rotary cultivator, firstly soil is Pulverized then dry cement is spread over, then water sprinkled in layers, again Remixed and shaped to camber., compacted using rollers.

#### **(1) Normal Soil-Cement—**

- ❖ It consists of 5 to 14% of cement by volume.
- ❖ Cement is sufficient to produce a hard and durable material.
- ❖ Sufficient water be used for hydration requirement & workability
- ❖ It is weather resistant and strong and used for stabilizing sandy and other low plasticity soils.

#### **(2) Plastic Soil-Cement—**

- ❖ It consists of 5 to 14% of cement by volume,
- ❖ It has more water to have wet consistency similar to that of plastering mortar at the time of placement.
- ❖ Used for water proof lining of canals and reservoirs
- ❖ Used for protection of steep slopes against water erosion.
- ❖

### **Fly ash stabilization**

Fly ash is a byproduct from burning coal which makes steam to generate electricity. When burning coal, combustion particles rise out of the combustion

chamber with flue gasses. They are captured in filters to prevent them from reaching the atmosphere and collected for disposal or beneficial reuse. These particles are called fly ash.

There are two types of fly ash, Class C and Class F. Class C has self-cementing properties and is used in the production of concrete as a substitute for Portland Cement, and as a chemical stabilizing & modifying agent to dry and/or strengthen poor soils. Class F has very little self-cementing properties, but can be combined with additives such as quicklime, hydrated lime, or cement (portland or hydraulic) to create cementitious compounds for the same purposes.

### **Fly Ash in Modification, Stabilization and FDR**

**Soil Modification:** Given its cementitious properties, fly ash can dry down wet soils and increase the strength of each fill layer. It works best in sandy/silty soils, but can be very effective in lean clays as well.



**Soil & Base Stabilization:** Using fly ash to strengthen the top 8"-14" of subgrade can decrease the thickness of aggregate base and/or pavement (asphalt or concrete) needed to achieve the structural design strength of the overall pavement section. Again, it works best in sandy, silty soils, but is also a great option to stabilize existing aggregate base when performing parking lot repairs or upgrades.



**Full Depth Reclamation:** Depending on the existing make-up of the current pavement & aggregate base, fly ash can be used by itself, or in combination with other additives, to rehabilitate entire pavement sections in place.



Fly ash yields less strength gain than Portland Cement. Typically, you need to use twice as much product to achieve similar results when compared to cement. However, if a fly ash source is within proximity of a project, utilizing it could be a better value and is worth comparing.

### **Base Course:**

#### **Preparation of base course**

It is the layer immediately under the wearing surface (Applies whether the wearing surface is bituminous or cement concrete and or more inch thick or is but a thin bituminous layer). As base course lies close under the pavement surface it is subjected to severe loading. The material in a base course must be of extremely high quality and its construction must be done carefully.

#### **Types of Base Course**

1. Granular Base Course
2. Macadam Base
3. In-water bound Macadam
4. Treated Bases

#### **Brick soling**

Soling in the construction field is the bottom-most layer of any component of the structure. It may be under floor or road. Soling may consist of bricks, stone cutting or such other building material having good crushing strength. It is one of the most common techniques used for soil stabilization.

#### **Water Bound Macadam**

The concept of water bound macadam road was suggested by John Macadam, who was a Scottish engineer. The road whose wearing course consists of clean crushed aggregates, mechanically interlocked by rolling and bound together



with filler material and water laid on a well compacted base course, is called water bound macadam (W.B.M) road.

This is constructed as village road serves as a base for bituminous roads. In most of the roads projects, in the first phase, W.B.M roads are constructed and when the funds are available, the surfacing is done with the premix carpet bituminous macadam or cement concrete. So a water-bound macadam road is considered as the mother of all types of road construction.

### **Wet-mix Macadam**

Aggregates used are of the smaller sizes, varies between the 4.75 mm to 20 mm sizes and the binders(stone dust or quarry dust having PI(Plasticity Index) not less than 6%) are premixed in a batching plant or in a mixing machine. Then they are brought to the site for overlaying and compaction.

The PI(plasticity Index) of the binding material is kept low because it should be a sound and non plastic material. If the plasticity index is more then there are the chances of the swelling and more water retention properties. So this value should be kept in mind.

**Comparison of the WBM and WMM road construction:** Although the cost of construction of the WMM is said to be more than that of the WBM sub-base and bases but the advantages given below will compensate for that. Here are the points of difference:

1. The WMM roads are said to be more durable.
2. The WMM roads gets dry sooner and can be opened for traffic withing less time as compare to the WBM roads which take about one month for getting dry.
3. WMM roads are soon ready to be black topped with the Bituminous layers.
4. WMM roads are constructed at the faster rate.
5. The consumption of the water is less in case of the WMM roads.
6. Stone aggregates used in WBM is larger in size which varies from 90 mm to 20 mm depending upon the grade but in case of the WMM size varies from 4.75 mm to 20 mm.
7. In case of WBM, stone aggregates, screenings and binders are laid one after another in layers while in WMM, aggregates and binders are premixed in the batching plants and then brought to the site for overlaying and compacting.
8. Materials used in the WBM are the stone aggregates, screenings and binder material (Stone dust with water) while in WMM material used are only stone aggregates and binders.
9. Quantity of the WBM is generally measured in cubic meters while that of the WMM in square meters.

### **Surfacing:**

- Surface dressing**

- ❖ A Surface Dressing is a process of spraying a road surface with bituminous binder and then covering the binder with clean, crushed aggregate or natural gravel.
- ❖ These layers are then rolled in order to press the aggregate into the binder film.
- ❖ Traffic movement commences the process of chipping movement which will produce eventually an interlocking matrix.

The main objective of adopting surface dressing as a wearing coat over bituminous macadam is to achieve water proofed, anti skid but comparatively less expensive wearing coat which can last for more duration as compare to other wearing surfaces.

#### **(i) Premix carpet**

Premix carpet (PC) is the oldest hot mix in India. It is a good, economical, bituminous wearing course mix to be placed directly on water bound macadam (WBM) of low-volume rural roads. The premix carpet is also provided with a bituminous sand seal coat to minimize direct penetration of rainwater into it.

#### **(ii) Semi dense carpet**

The semi-dense bituminous concrete mixes have neither dense or open graded characteristics. It consists of the so called pessimum voids when they are fully constructed. This will create the separation of aggregate and the bitumen in the BM layer.

#### **Bituminous concrete(BC)**

- BC is a dense graded bituminous mix used as wearing course for heavily trafficked roads.
- BC mix consists of coarse aggregates, fine aggregates, filler and binder blended as per marshall mix design.

#### **Quality control operations involved are:**

- Design of mix in laboratory, and control of mixing, laying and rolling temperatures
- Density, Marshall Stability, Flow, Air Voids, Retained Stability, Bitumen Content, Gradation of aggregates are controlled
- Riding quality is a control

#### **Grouting**

Grouting is generally a mixture of cement, sand and water. Different type of grouting are used for different purposes but generally They are used in the purpose of repairing of concrete cracks, filling seams and gaps in tiles, seal and fill gaps for waterproofing courses, and for soil stabilization in boring well and foundation. It is also used to give extra strength to the foundations of load-bearing structures.

Grouting in civil engineering refers to the injection of pumpable materials into a soil or rock formation to change its physical characteristics. It is one of the ways ground water can be controlled during civil engineering works

Grouting is suitable where soil permeability would create a heavy demand on pumping or where ground conditions mean it may be economically inefficient to bore wells. Grout may also be used in the formation of pile foundations, ground anchors, under-reaming, underpinning, in road construction, dam construction, and other applications.

Different materials may be used for grouting depending upon factors such as the soil or rock type and the area to be grouted. However, the basic process is the same: the soil or rock is injected with fluid grout which sets and reduces or acts as a sealant on the material's permeability.

Grouting is relatively costly and so wastage must be controlled. This is achieved by the use of additives which improve the gelling properties of the grout and limit its spread through the ground.

## **HILL ROADS**

### **Introduction:**

- Roads constructed in mountains region is called hill roads.
- There are different considerations while designing hill roads as compare to plain area roads.
- Types of curve used in hill roads is of different than plain road.
- All geometric parameters will gets changes while designing hill roads such as- Curves, Super elevation, SSD, OSD, Extra Widening, etc.

### **Components parts of Hill Roads**

1. Road Bed
2. Side Drain
3. Parapet Drain
4. Catch Water Drains
5. Brest Wall
6. Retaining Wall
7. Cross Drains

### **Road Bed**

- The pavement portion of hill road is called road bed.
- **Function:** To resist stresses developed due to moving traffic.

### **Side Drain**

- Drain provided on the sides of road is called side drain.
- Side drains runs parallel to the length of road.
- **Function:** To collect and drain off rain water collected from camber of road.

### **Parapet Wall**

- Wall which is provided above the formation level in the down side slope is called parapet wall.
- **Function:** Protection to the traffic against falling down the hill slope.

### Catch Water drain

- It is drain provided on higher slope running parallel to the length of road.
- **Function:** To make intercept for runoff coming from top of hill and divert water in to nearby cross drains.

### Brest Wall

- The wall constructed to upside slope is called retaining wall.
- **Function:** Protect road from sliding of upside slope.

### Retaining Wall

- The wall constructed to down side slope of road is called retaining wall.
- **Function:** To protect down slope from sliding.

### Cross Drains

- The drain which is laid along width of road is called cross drains.
- **Function:** To drain off rain water collected in side drains and catch drains.

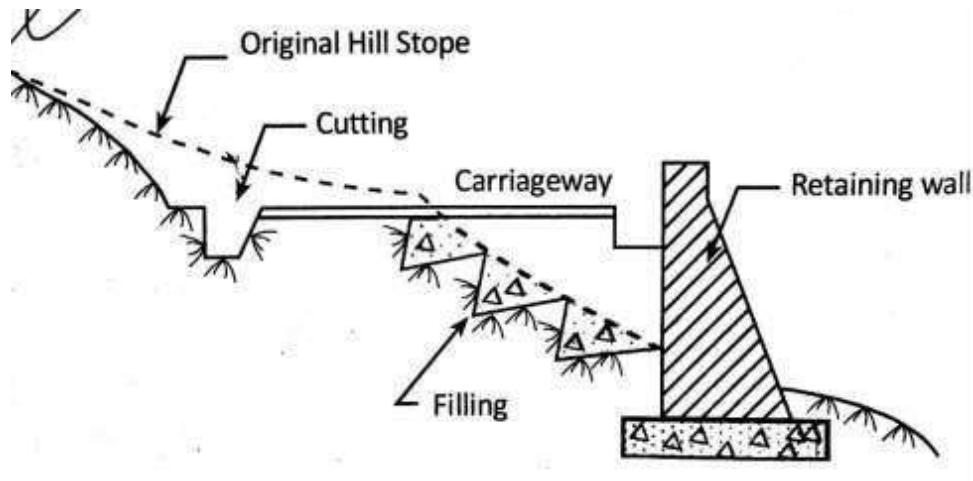

Image of Hill Road

### Typical cross-sections hill road :-

The cross section of a road in a hilly terrain is determined by the original ground slope of the site, the slope of the road formation, width of roadway, side drain size, and shape and so on. Various types of road cross-section are:

1. Cut and fill
2. Bench type
3. Box cutting
4. Embankment with retaining walls
5. Semi bridge
6. Semi tunnel
7. Platforms



Typical Cross Sections of Hill Road

### Cut and fill

When roadbed slope has a gradient 2% or more a cut and fills road bed is cheaper and environmentally friendly as well. The fill mass is generally balanced by the cut mass. For adequate stability, benches are made on the surface of the hill side with a height of 0.5 m and length varying from 1.5 to 3.0m depending upon the slope.

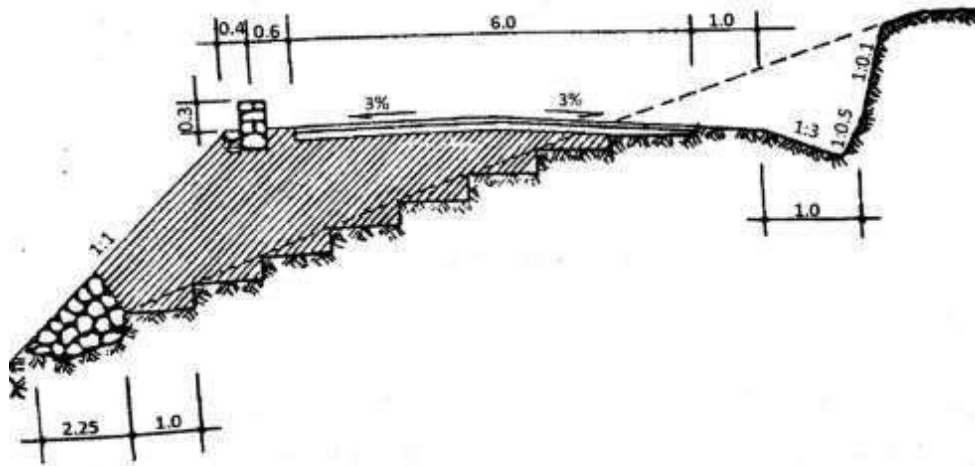

Typical Cross Sections of Cut and fill

### Bench type

A cross section of the bench type although entails some increase in earthwork but ensures the complete stability of the road bed, if hill side is itself stable.

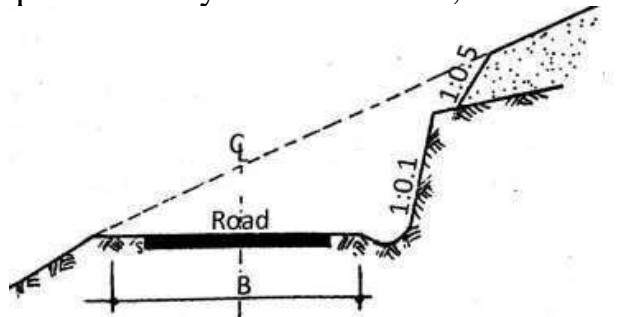

Typical Cross Sections of Bench type

### Box cutting

When the location of road bed is unstable or unsuitable along the hillside due to one or other reasons, the road bed is designed as trench type of cross section. It increases earthwork to a large extent. It is introduced to meet the geometric design standards for a given category road.

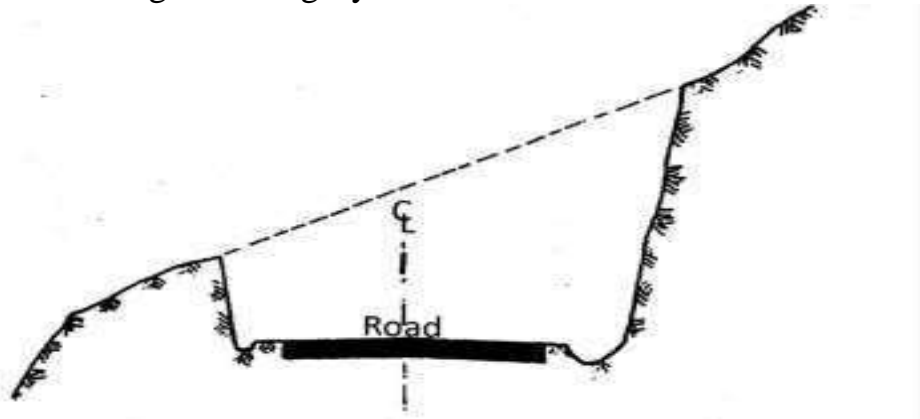

Typical Cross Sections of Box cutting

### Embankment with retaining walls

On steep slopes of about  $30-35^\circ$ , the earthwork involved in constructing the embankment increases substantially. The retaining wall is sometimes provided to reduce earthwork's cost and to increase stability. Also, the retaining wall is provided when embankment soil on steep grounds itself need support. They may also be constructed on a less steep ground slope to increase the stability of road bed.

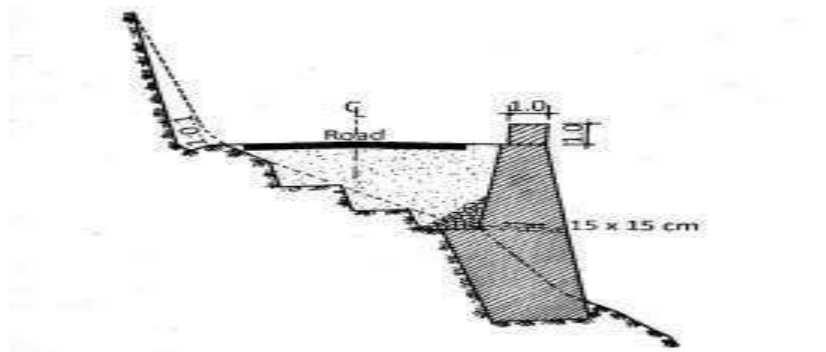

Typical Cross Sections of Embankment with retaining walls

### Semi Bridge

If the road is located on a hill slope the retaining wall needs to be at a substantial height. In such cases, to reduce quantities of work, road bed with a semi-bridge type of structure may be constructed.

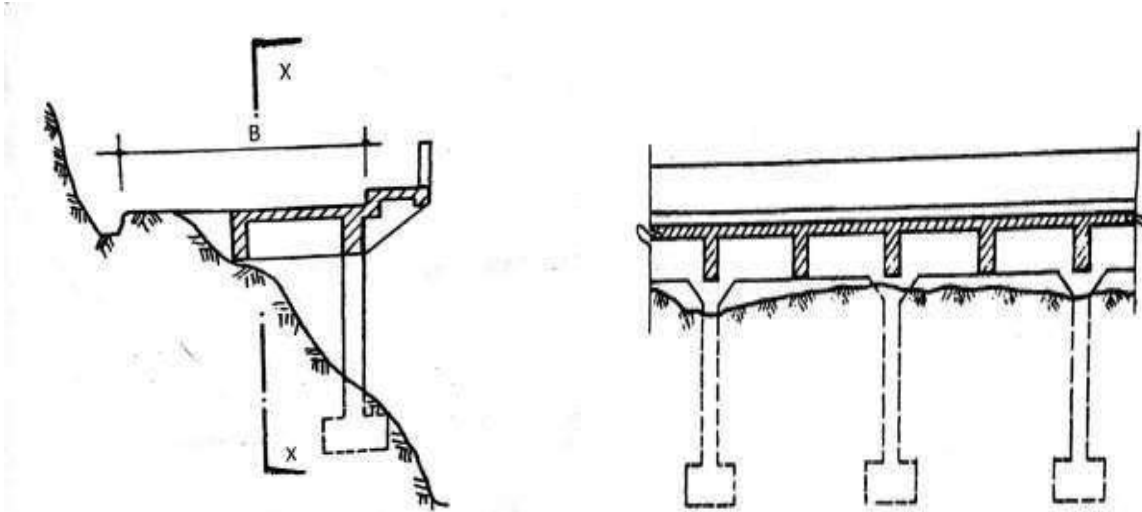

Fig: Cross Section and L-Section (X-X) of a Semi-Bridge.

### Semi tunnel

When inscribing is to be cut into steep hills in stable rock faces, the rock may be permitted to overhang the road to reduce rock works. Such a cross section is called a semi-tunnel.

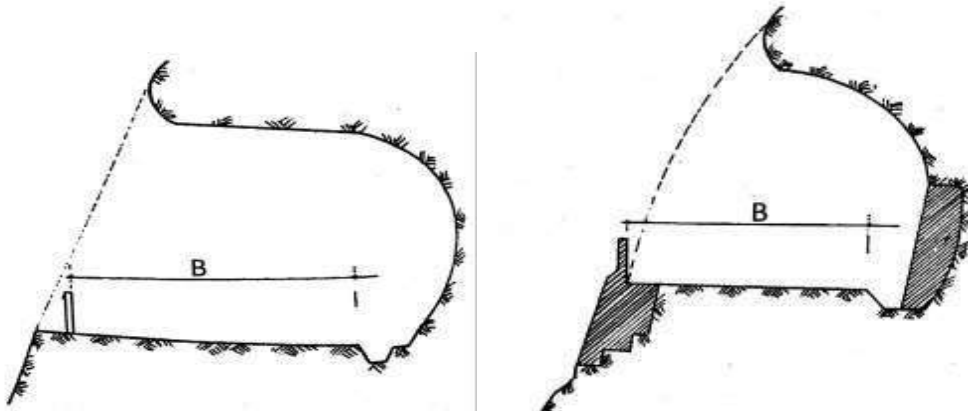

Fig: With Accommodating Road-Way Only and With Retaining and Breast Walls

### Platform

On the precipitous slopes, where shifting of the route into the hillside will lead to enormous rock works which eventually increases the cost and where semi-tunnel cannot be constructed, platforms are usually cantilevered out of the rock on which road way is partially located.



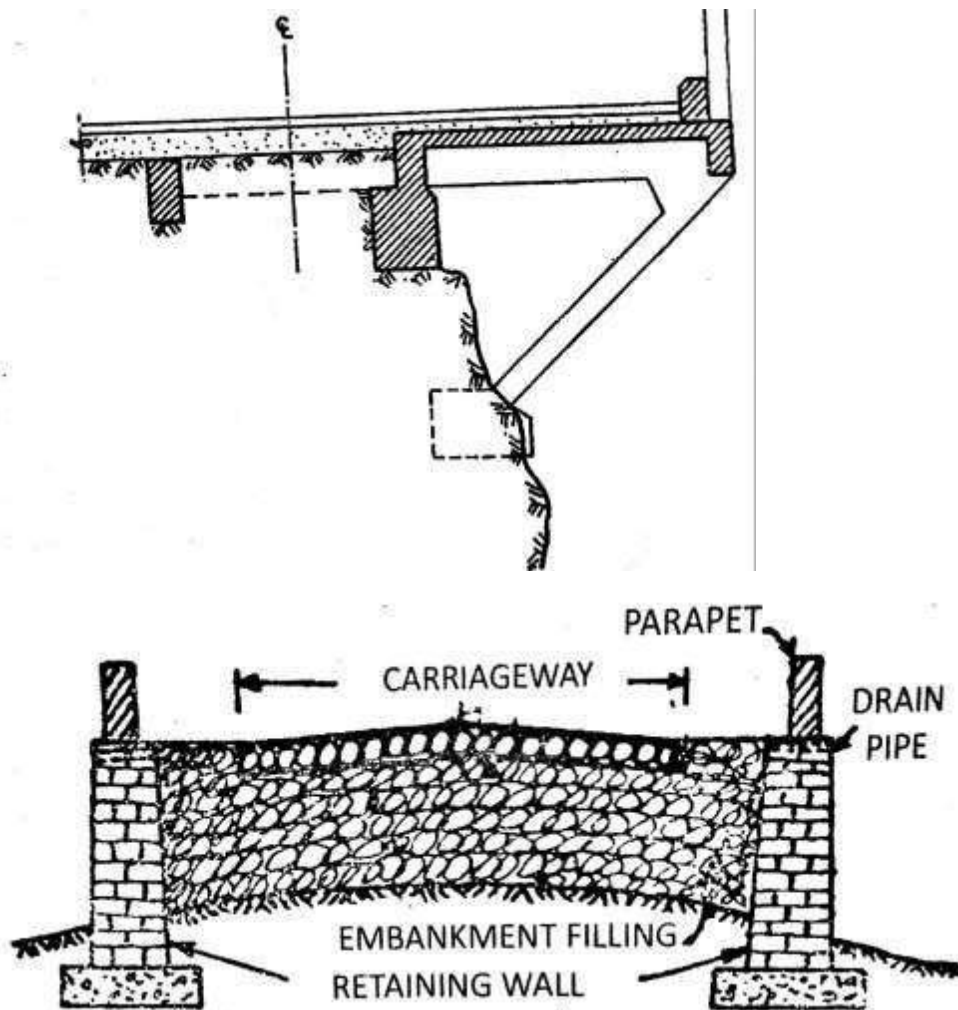

Fig: Fully In Embankment

### Breast Walls

A breast wall is constructed to protect the natural sloping ground from the cutting action of natural agents. Breast walls also prevent slides of unreliable soils. The breast walls may be 0'6 m wide at the top. Weep holes should be provided at regular interval among the length of the wall to relieve the walls of saturated earth pressure. The breast wells are so designed that their line of pressure should be normal to the earth pressure or thrust.

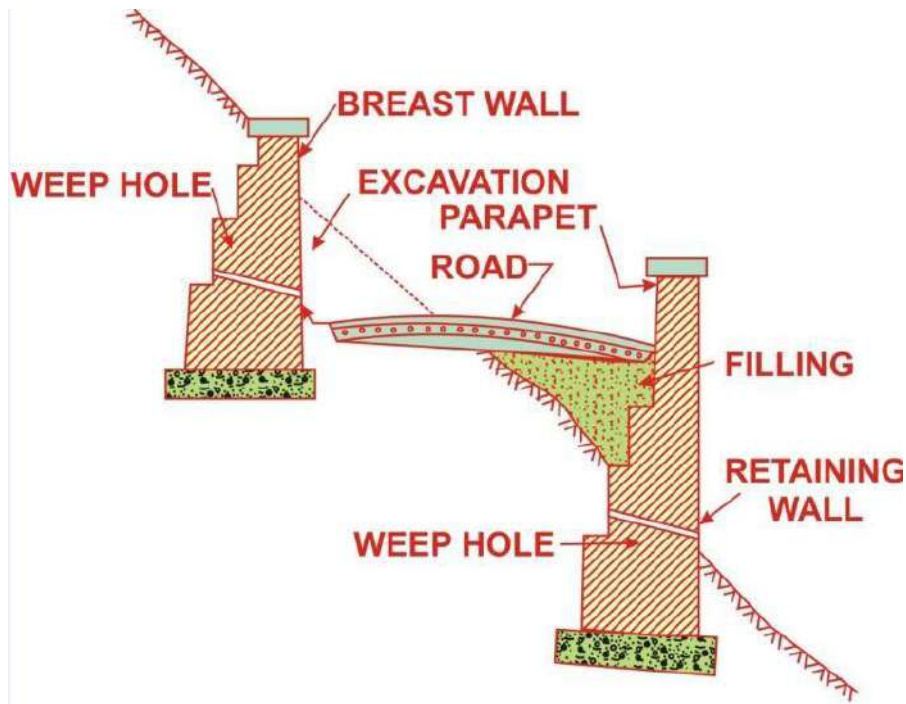

Fig. Retaining wall and breast wall

### Retaining walls

The walls constructed for retaining or supporting earth against their back are called retaining walls. Earth cannot remain vertical but would be in a state of equilibrium when it assumes a natural angle which is called *angle of repose*. If it is desired to be retain the earth vertically, that portion of the earth will have to be supported by a wall called retaining wall. The back of the wall is in the form of steps and the face of the retaining wall may be either vertical or battered. The width at the base will depend upon the height of earth to be retained as the more the height, the greater will be the pressure at the base and the top can be kept 2 bricks thick .

### Different between Breast walls and Retaining walls :

1. Breast wall and Retaining wall structure stand off to protect a freshly cut or old surface of a natural hill face.
2. Breast wall and Retaining wall structure prevent of hill slides under the action of weather and rain water flowing over hills slope. Retaining wall is provided to the downside of the road while breast wall uphill side of the road in hilly area.
3. Impact of snow, avalanches, landslides and surcharge are not considered in the design of Breast wall while in retaining wall all those factors are considered.
4. Height of breast wall shall not exceed 3 meter and for retaining wall we did not have such type of criteria.
5. Breast wall are not required to be constructed where back mass comprises of rocks or stable strata deposit of soil mass and for protecting the unstable soil mass we need retaining wall.

6. Retaining wall used for support artificial cutting or slope while breast wall used to support natural slope.
7. Design of retaining of wall capable to resist uplift pressure force and hydro static pressure for developed while breast wall is used to transfer the load.

### Different types of curves :

The following types of curves are mostly found on hill Roads:-

- 1.Hair-Pin bend curves
- 2.Salient Curves
3. Re-entrant Curves

#### 1.Hair-pin curves:

- This type of curve modifies its direction via an angle of 180 degree down the hill on the similar side is defined as hair-pin curve.
- A Hair-Pin Bend: This curve is known as a hair-pin bend since it adheres to the shape of a hair-pin. If a bend is developed at the hair-pin curve in a hill road, it is called as hair-pin bend.
- This type of curve should have been situated on a hill side containing the lowest slope and highest strength. It is considered as very secure from view point of landslides and ground water. The ideal Hair-pin bends should contain long arms and farther spacing. They minimize construction issues and high-priced protective works.
- Hair-pin curves or bends with snakelike form are difficult to arrange and as a result they should not be recommended at all.

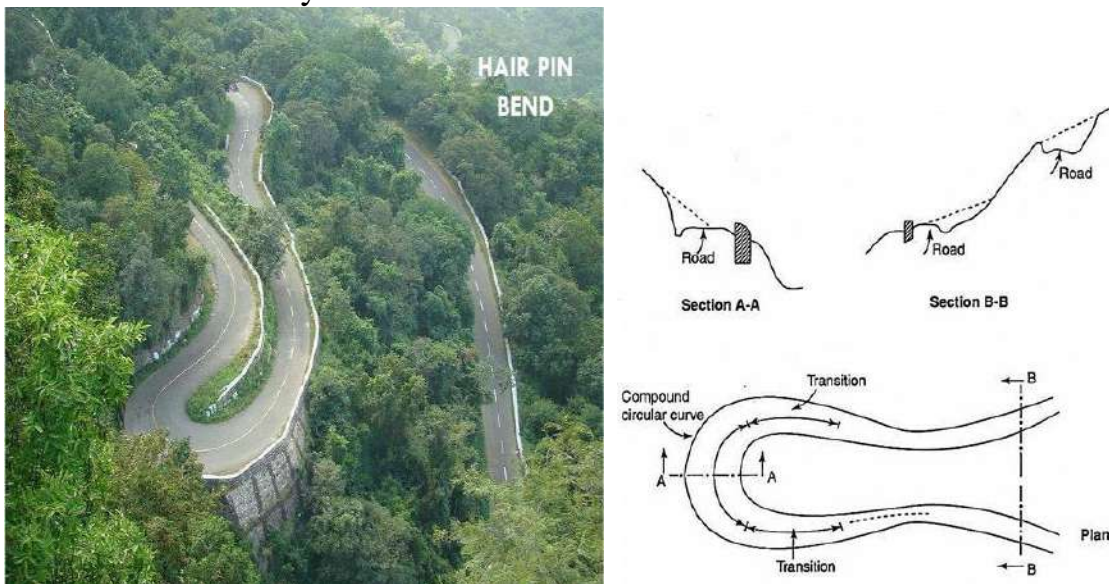

Schematic dig. of hair pin bend curve

#### 2. Salient curves:

- The curves which contain their convexity on the exterior edges of a hill road are defined as salient curves.

- The centre of curvature of a salient curve is located towards the hill side. This type of curve appears in the road length that is built up on the ridge of a hill. The bend that is developed at the salient curve in a hill road is called corner bend.
- Salient curves are very harmful for the traffic moving speedily. At such a curve or at corner bend, the segment of projected hill side is normally curtailed to make the perceptibility better.
- It is demonstrated in the following figure (re-entrant curve). In the exterior perimeter of the road, the curve is basically arranged with a parapet wall for safeguarding the vehicles from falling down the hill slope.

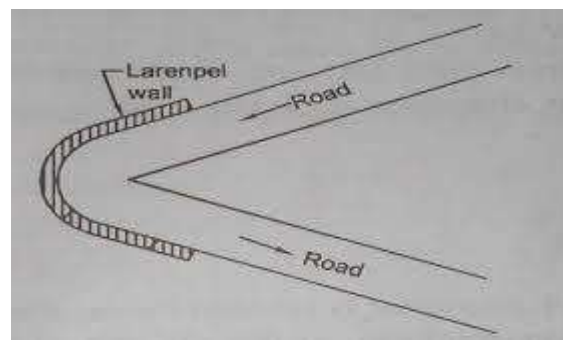

Schematic dig. of Salient curve

### 3. Re-entrant curves:

- The curves which contain their convexity on the inside edge of a hill road are known re-entrant curves.
- The centre of curvature of re-entrant curves is located ahead of the hill side. This type of curve appears in the road length that is built up in the valley of a hill.
- These curves are not harmful since they offer sufficient visibility to the traffic moving speedily. In such curves, the parapet wall is arranged only for protection for fast moving traffic.

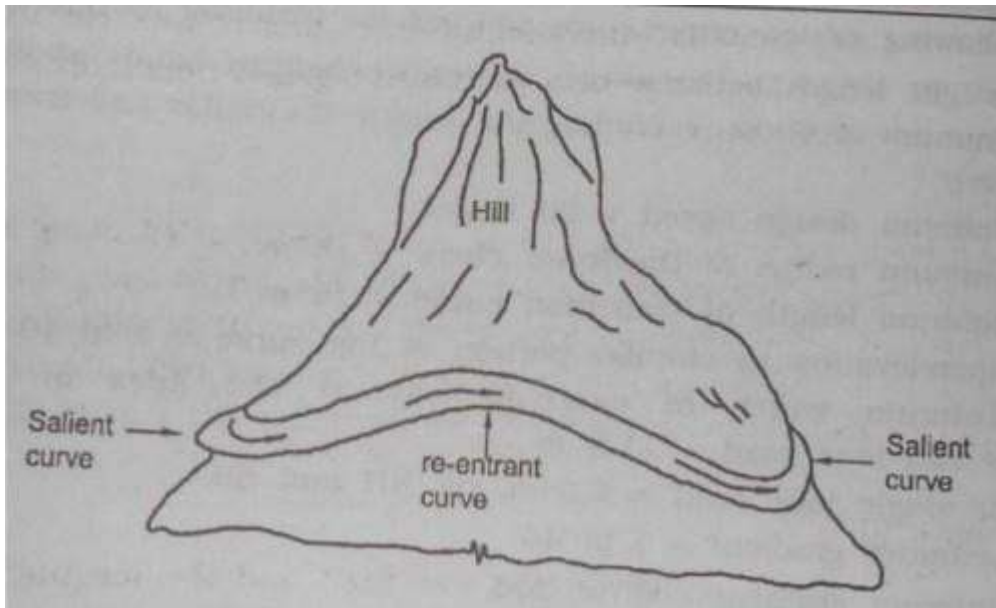

Schematic dig. of Re-entrant curve

## ROAD DRAINAGE

### Introduction:

Highway drainage is the process of removing and controlling excess surface and sub-surface water within the right way. This includes interception and diversion of water from the road surface and sub-grade. The installation of suitable surface and sub-surface drainage system is an essential part of highway design and construction.

During rain, part of the rain water flows on surface and part of it percolates through the soil mass as gravitational water until it reaches the ground water below the water table. Removal and diversion of surface water from the roadway and adjoining land is termed as surface drainage, while the removal of excess soil-water from the sub-grade is termed as sub-surface water.

### Necessity of road drainage work :

Highway drainage is important from various view points:

- Excess moisture in soil sub-grade causes instability under the road surface. The pavement may fail due to sub-grade failure. In some clayey soil variation in moisture content causes considerable variation in volume of sub-grade. This sometimes contributes to pavement failure.
- The waves and corrugations formed in case of flexible pavements also play an important role in pavement failure.
- Sustained contact of water with bituminous pavements causes failure due to stripping bitumen from the aggregates like loosening of some of the bituminous pavement layer and formation of pot holes.
- The prime cause of failures in rigid pavements by mud pumping is due to the presence of water in fine sub-grade soil.

- Excess water on shoulders and pavement edge causes considerable damage.
- Excess moisture causes increase in weight and thus increase in stress and simultaneous reduction in strength in soil mass. This is one of the main reasons of failure of earth slope and embankment foundations.
- In place where freezing temperatures are prevalent in winter, the presence of water in sub-grade and a continuous supply of water from the ground water can cause considerable damage to the pavement due to frost action.
- Erosion of soil from top of un-surface roads and slopes of embankment, cut and hill side is also due to surface water.
- Failure due to hydraulic pressure and failure due to binder stripping can be avoided with the help of proper drainage on roads.

### **Cross drainage works :**

For streams crossing the runways, drainage needs to be provided. Also often the water from the side drain is taken across by these cross drains in order to divert the water away from the road, to a water course or valley in the form of culverts or bridges. When a small stream crosses a road with linear water way less than amount six meter, the cross drainage structure provided is called culvert; for higher value of linear waterway, the structure is called bridge.

### **Types of Cross-drainage Structures:**

1. Culverts (waterway less than 6 m)
2. Minor bridges (waterway from 6-30 m)
3. Medium-sized bridges (waterway from 30-100 m)
4. Major bridges (waterway more than 100 m)
5. Causeways

Categories (2) and (3) may also be clubbed and called Minor bridges. Bridges are designed such that they are not submerged even under the highest flood expected in a design period of, say 50 years or 100 years, depending upon the importance of the highway and the bridge.

From the point of view of economy, a bridge may be designed to be submerged and cause interruption of traffic a limited number of days in a year. Such bridges are called submersible bridges.

### **Culverts:**

#### **The popular types of culverts are:**

- (i) Masonry arch culverts
- (ii) Slab culverts (Stone slab or R.C.C. slab with abutments and piers)
- (iii) Pipe culverts (Metal pipe, Stoneware pipe, or R.C.C. Hume pipe)
- (iv) R.C.C. Box culverts

**Bridges:**

Bridge engineering is a specialised field.

**The following are types of bridges for spans in the increasing order:**

- (i) Masonry arch
- (ii) R.C.C. slab (simply supported)
- (iii) R.C.C. T-beam (simply supported)
- (iv) Continuous T-beam and slab of R.C.C.
- (v) R.C.C. balanced cantilever
- (vi) Pre-stressed concrete
- (vii) Suspension bridges.

**Causeways:**

Causeways allow water to flow over them when the stream or water course receives floods. These are provided on relatively unimportant roads with small volume of traffic.

The interruption to traffic on these structures should not be for more than 15 days in a year and not exceed 3 days at a stretch.

Depending upon the degree of interruption, causeways may be called low-level causeways or high-level causeways.

**Surface drainage :**

The surface water is to be collected and then disposed off. The water on the surface is first collected in longitudinal drains, generally in side drains and then the water is disposed off at the nearest stream, valley or water course. For the preparation of surface drainage, we should keep in mind various things like

Seeing the amount of rainfall and slope a suitable camber is to be provided for collection of surface water. The shoulders of rural roads are constructed with suitable cross slopes so that the water is drained across the shoulders to the side drains. These side drains of rural roads are generally Open (kutchha) drains of trapezoidal shape, cut to suitable cross-section and longitudinal slopes. These sides are provided parallel to the road alignment and hence these are also known as longitudinal drains. In embankments the longitudinal drains are provided on one or both sides beyond the toe; in cutting, drains are installed on either side of the formation.

In urban roads because of the limitation of land width and also due to the presence of footpath, diving island and other road facilities, it is necessary to provide underground longitudinal drains. Water drained from the pavement surface can be carried forward in the longitudinal direction between the kerb and the pavement for short distances which may be collected in catch pits at suitable intervals and lead through underground pipes.

Drainage of surface water is all the more important in hill roads. In hill roads disposal of water is also very important. Certain maintenance problems may arise due to faulty hill road construction.

### **Procedure for Design of Open Drains:**

The following are the steps for designing open drains:

1. For the known soil conditions, calculate the Manning's rugosity coefficient, side slopes, and the maximum permissible velocity.
2. Determine the slope of the drain from the topography.
3. For the runoff or discharge expected to be drained, calculate the hydraulic mean depth using Manning's formula.
4. Calculate the cross-sectional area from the discharge and the maximum permissible velocity.
5. From the result of (3) and (4), solve the two simultaneous equations to obtain the bottom width and depth.
6. Calculate the critical depth and determine whether the flow is streamlined or turbulent. If the flow is streamlined, add a free board to the depth and finalise the cross-section. If the flow is turbulent, it may be necessary to decrease the longitudinal slope, or line the channel.

### **Subsurface Drainage:**

Moisture changes in the subgrade occur due to percolation of rain water and seepage flow, as also due to the phenomenon of capillary rise. The aim of subsurface drainage is to keep the ground water table (GWT) sufficiently below the level of the subgrade – at least 1.2 m.

When the water table is almost at the natural ground surface, the best option is to raise the formation of the roadway on an embankment, such that it is 1.2 m above the ground. If this is not possible for the reason of unfavourable topography, the only option is to lower the ground water table by means of subsurface drainage arrangements. It must, however, be remembered that only gravitational water in the soil can be drained, but not 'held water', which is made up of the moisture film around the grains.

**A few drainage arrangements for different situations are discussed below:**

#### **Subgrade Drain:**

One option is to install a drain in the pervious layer besides the road to intercept the ground water before it can reach the subgrade, as shown in Fig.



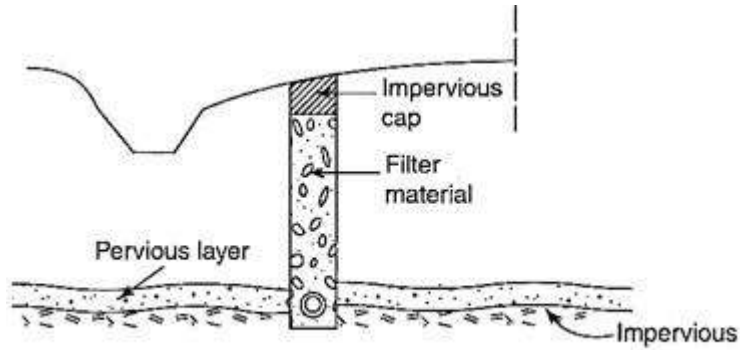

Fig. Subsurface drain to intercept drain water

**Longitudinal Drain Trenches and Pipes:**

If the soil is relatively pervious, longitudinal drainage trenches with drain pipe, backfilled with filter sand can be used. The depth of the trench depends on the extent of lowering required, soil type, and distance between the trenches. A typical arrangement is shown in Fig.

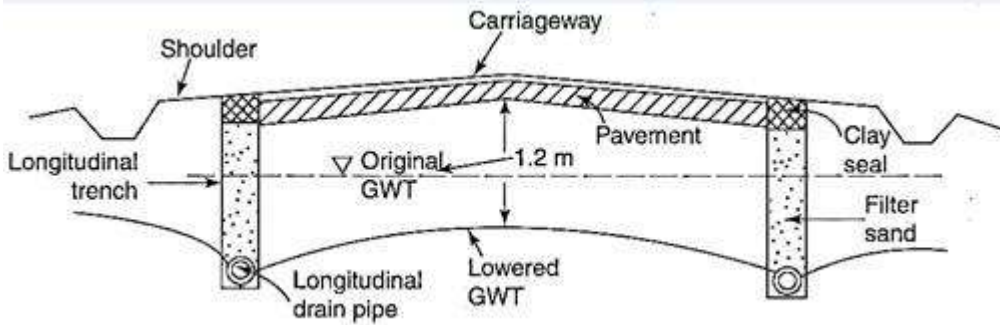

Fig. Lowering GWT in pervious soil by Subsurface drains

**Longitudinal and Transverse Drains for Lowering GWT:**

If the soil is relatively less permeable, longitudinal as well as transverse drains may be needed to lower the ground water table as shown in Fig.

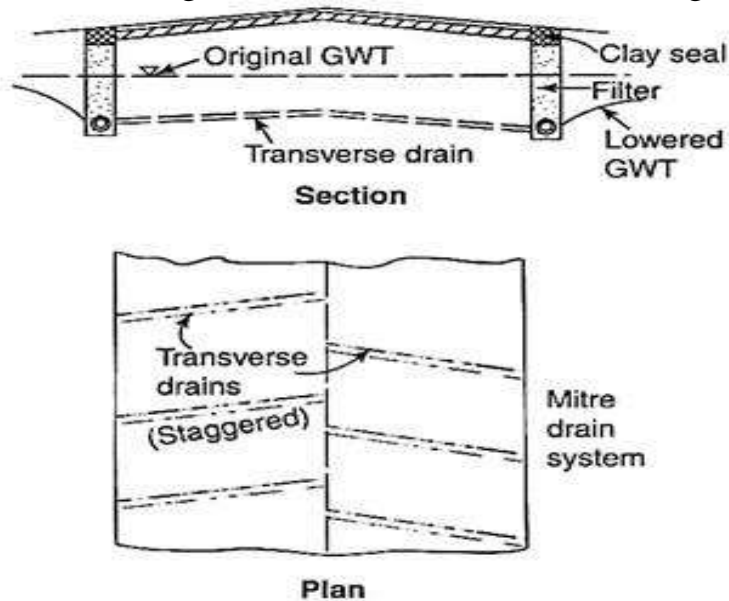

Fig. Longitudinal and transverse drain system for less permeable soil

### Capillary Cut-Off for Clayey Subgrade:

If the subgrade is clayey, the system of sub-surface drains on either side will not be effective, in view of very low permeability of the subgrade. In such a case the subgrade has to be raised with a free-draining material, or a capillary cut-off has to be applied as shown in Fig.

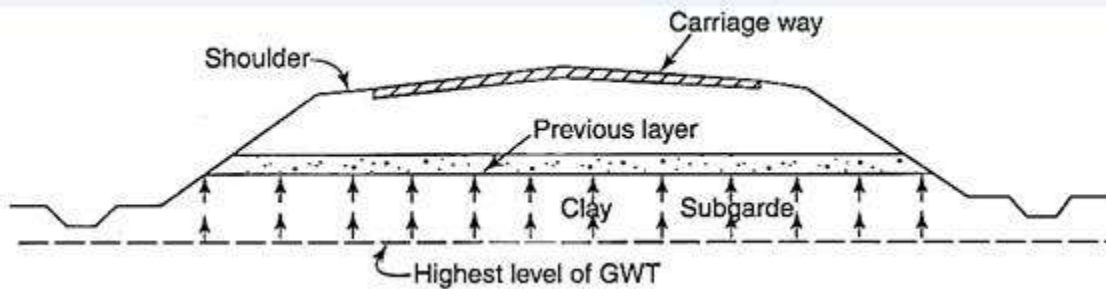

Fig. Capillary cut-off for a clayey subgrade

The capillary cut-off may even be an impermeable bituminous layer.

The location of the cut-off should be above the level of capillary rise expected for the clayey subgrade.

### Sub-Surface Drains to Control Seepage in Cut Slopes:

Sometimes, seepage water renders cut slopes unstable by reaching the face of the slope. This can be prevented by lowering the seepage line by providing a sub-surface longitudinal drain installed to a depth below the pervious layer as shown in Fig.

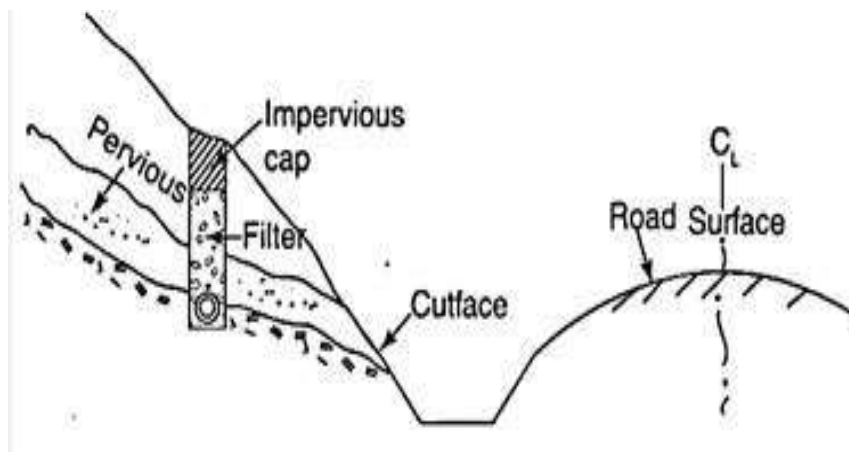

Fig. Subsurface drains at cut slope to control seepage

If the depth of pervious layer is more, horizontal drains comprising perforated metallic pipes or PVC pipes installed at a suitable slope may be provided to serve the same purpose.

### Drain Pipes and Filter Media:

A subsurface drain may comprise of perforated pipe, a porous concrete pipe or solid pipe laid with open joints. Alternatively, a trench filled with a free draining material may be used to serve the purpose of a drain.

A perforated pipe or a porous pipe (of no fines concrete) with an impervious cap at the top, laid in a trench and backfilled with a granular, free-draining material top is considered to be a good choice.

If granular filter material with appropriate gradation has to be used, it has to be designed to satisfy certain criteria.

### Design of a Filter Material:

**The gradation requirements of the filter material are based on three criteria:**

- (i) Permeability of filter
- (ii) Prevention of Piping (because of high seepage velocity)
- (iii) Prevention of clogging of the drain pipe.

**These requirements are:**

$$(i) \text{ Permeability ratio: } \frac{D_{15}(\text{filter})}{D_{15}(\text{soil to be drained})} > 5$$

$$(ii) \text{ Piping ratio: } \frac{D_{15}(\text{filter})}{D_{85}(\text{soil to be drained})} < 5$$

$$(iii) \frac{D_{85}(\text{filter})}{(d_p: \text{ diameter of the perforation in the drain pipe.})} > 2d_p$$

Fig. shows an example of the selection of a suitable filter material based on the gradation of the soil to be drained.

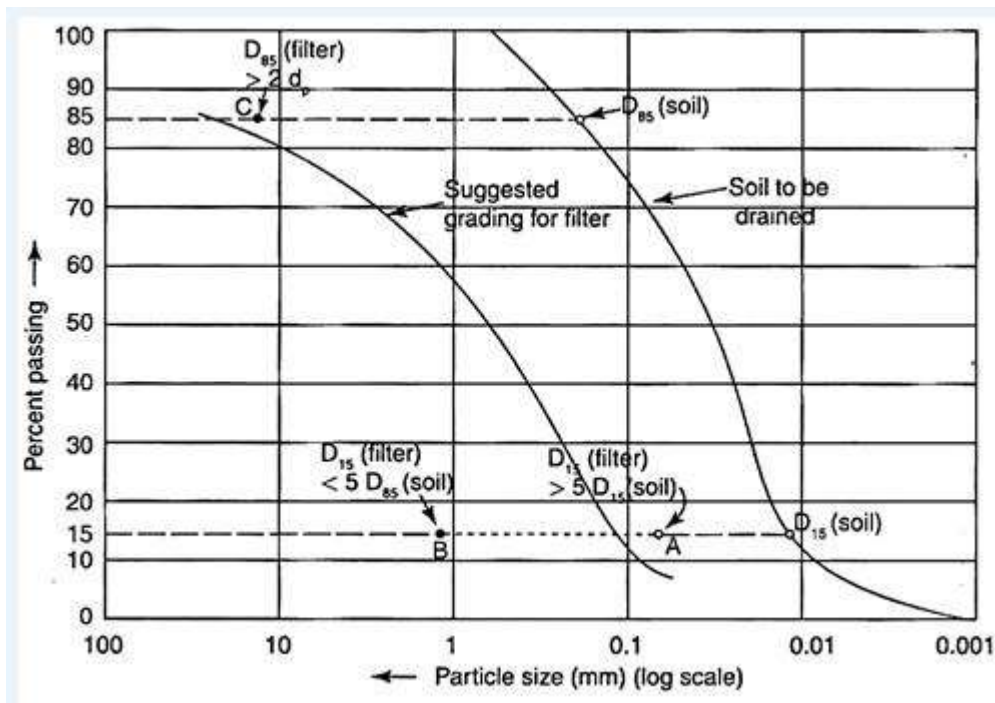

Fig. Filter design for subsurface drains

Set the grading of the soil to be drained be plotted as shown. Mark the  $D_{15}$  and  $D_{85}$  of the soil. From permeability criterion, mark  $D_{15}$  of filter ( $>5D_{15}$  of soil) as A.

From piping criterion, mark  $D_{15}$  of filter ( $<5D_{85}$  of soil) as B.

On  $D_{85}$  line, mark point C, such that  $D_{85}$  (filter) is greater than  $2d_p$  ( $d_p$  being the diameter of the perforation of the drain pipe).

A suggested grading of filter may be drawn smoothly such that it lies to the left of C and lies between A and B as shown.

The perforated pipe is usually 100 to 150 mm in diameter with holes in two or more lines towards the bottom of the pipe. The collector pipes of porous concrete, metal or PVC should be laid with a minimum of 100 mm of filter sand around them.

Usually 5 mm diameter holes are considered adequate, if restricted to the lower  $60^\circ$  arc of the pipe. Solid pipes with open joints may be used, but care should be taken to see that silt and fine sand do not enter the pipe.

When the flow of water takes place through porous backfill of graded sand, it is likely to be clogged after some time. Hence, this involves maintenance, washing of the clogged backfill .

### **Geosynthetics in Subsurface Drains:**

Geosynthetics or geotextiles are becoming popular as substitutes or alternatives to graded filters. They have high retention fine particles and permeability similar to graded material and good tensile strength. Installation is also easy. Geosynthetic products perform the functions of a filter as well as that of a separator.

Fig. shows an aggregate drain with a pipe encased in a geosynthetic.

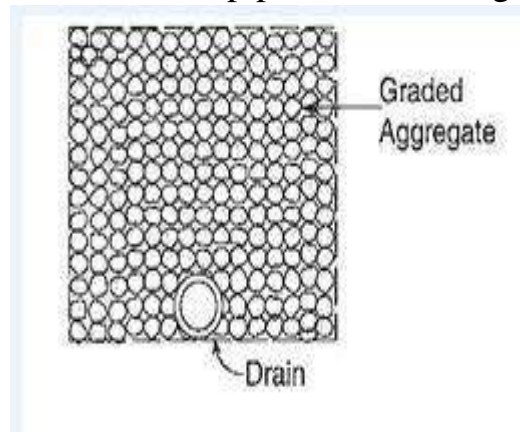

Fig. Geosynthetic-encased aggregate drain with a pipe

### **Shoulder Drainage:**

For quick drainage of water from the roadway, the shoulder surface has to be properly sloped. A continuous drainage layer, 75 to 100 mm thick, can be laid under the shoulder at the bottom level of the sub-base or the bottom-most granular sub-base layer and extended up to the edge. A paved shoulder, if

provided, should have a cross- slope of at least 0.5% more than the camber; the unpaved shoulder beyond this should be a further 0.5% steeper as shown in Fig.

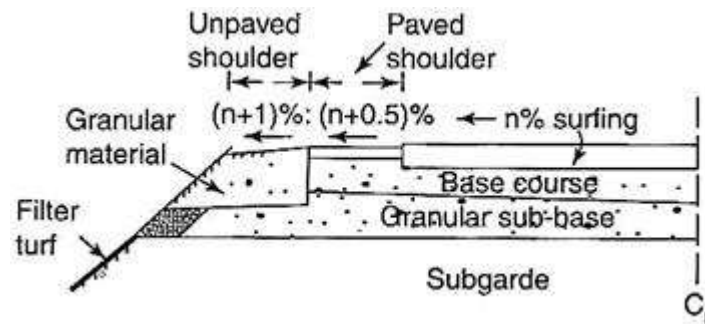

Fig.Shoulder Drainage

### Median Drainage:

Narrow medians may be drained towards the pavement. Medians with a width of up to 1.8 m can be provided with kerbs and paved; those with width ranging from 1.8 to 5 m are usually turfed and crowned for the surface water to run towards the pavement (which may be with or without kerbs). For medians that are more than 5 m wide, there are no kerbs at the edge.

If the carriageway drains towards the median, central drain may be made to carry the run off. At intervals, the drain may also be made to lead water to an outlet.

### Drainage of High Embankment:

In the case of high embankments (more than 8 metres high) as with bridge approaches, slopes and shoulders may be eroded by surface run-off. To prevent or minimise this, longitudinal drains are to be provided at the edges of the roadway, from which the water may be led down the slopes by means of lined chutes with energy dissipation basins at the toe.

The water thus collected at the toe can be led in an open toe drain at the bottom parallel to the road, and led to a natural outlet at an appropriate point. In between the chutes, the slope is to be turfed to protect it from surface erosion .

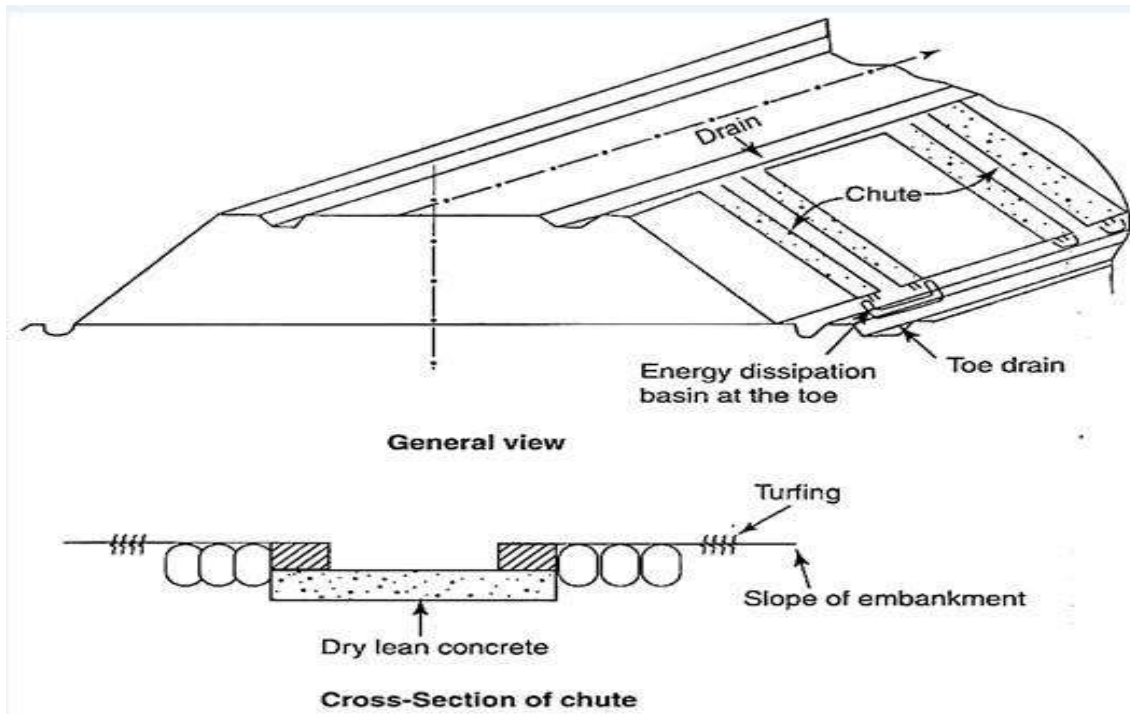

Fig. Drainage system for high Embankment

### **Drainage of Rotaries:**

Water, from the large area around a rotary, flows towards the centre of the rotary, because of the super-elevated pavements. This has to be collected and led into the overall drainage system. A typical arrangement is shown in Fig.

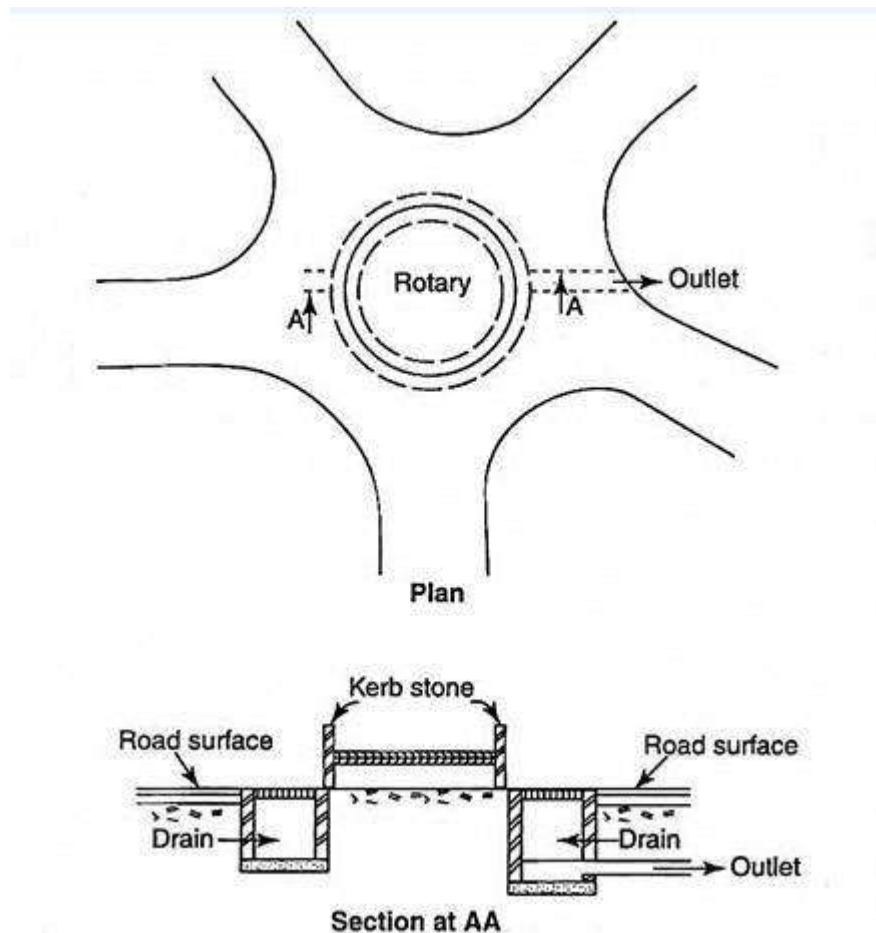

Fig. Typical drainage arrangement at a Rotary

Similar arrangements can be made at an intersection.

At a flyover, the water collected in longitudinal drains on either side of the pavements can be led through the hollows of pillars of the supporting structure like a bridge and led away through a storm water drainage system.

## ROAD MAINTENANCE

### Introduction

Road maintenance is essential in order to (1) preserve the road in its originally constructed condition, (2) protect adjacent resources and user safety, and (3) provide efficient, convenient travel along the route. Unfortunately, maintenance is often neglected or improperly performed resulting in rapid deterioration of the road and eventual failure from both climatic and vehicle use impacts. It follows that it is impossible to build and use a road that requires no maintenance.

Preserving and keeping each type of roadway, roadside, structures as nearly as possible in its original condition as constructed or as subsequently improved and the operation of highway facilities and services to provide satisfactory and safe transportation, is called **Road Maintenance** or **maintenance of highways**.



Fig. Roads Maintenance / Highways Maintenance Definition

### Road Maintenance Components

The various road maintenance function includes:

1. Surface maintenance
2. Roadside and drainage maintenance
3. Shoulder and approaches maintenance
4. Snow and ice control
5. Bridges maintenance
6. Traffic service

Highway maintenance is closely related to the quality of construction of original road. Insufficient pavement or base thickness or improper construction of these elements soon results in expensive patching or surface repair. Shoulder care becomes a serious problem where narrow lanes force heavy vehicle to travel with one set of wheels off the pavement.

Improperly designed drainage facilities, mean erosion or deposition of material and costly cleaning operation or other corrective measures. For regular highways maintenance and repair sharp ditches and steep slopes require manual maintenance as compare to cheap repair of flatter ditch and soil by machine.

In snowy country, improper location extremely low fills and narrow cuts leave no room for snow storage, creating extremely difficult snow removal problems.



## COMMON TYPES OF ROAD FAILURES – THEIR CAUSES AND REMEDIES

**Failures may be:-**

**Failure in sub grade**

- Inadequate Stability
- Excessive application of stresses
- Plastic deformation

**Failures in sub base or Base course**

- Inadequate stability
- Loss of binding action
- Loss of bearing course materials
- Inadequate wearing course

**Causes of premature failures:-**

- Rutting due to high variation in ambient temperature.
- Uncontrolled heavy axle loads.
- Limitation of pavement design procedures to meet local environmental conditions.

**Common Flexible Pavement Failure/ Distresses:-**

- Cracking
- Deformation
- Deterioration
- Mat problems
- Problems associated with seal coats

**Category**

**Distress type**

1. Cracking	Longitudinal, Fatigue, Transverse, reflective, block, edge
2. Deformation	Rutting, Corrugation, Shoving, depression, overlay bumps
3. Deterioration	Delamination, Potholes, Patching, raveling, stripping, Polished aggregate, Pumping
4. Mat Problems	Segregation, Checking, Bleeding
5. Seal coats	Rock loss, Segregation, bleeding/fat spots, Delamination

**Types of Distresses/Failures and Definitions:-**

**Alligator Cracking**

Alligator cracking is a load associated structural failure. The failure can be due to weakness in the surface, base or sub grade; a surface or base that is too thin; poor drainage or the combination of all three. It often starts in the wheel path as longitudinal cracking and ends up as alligator cracking after severe distress.

**FIX:** Because a structural failure is taking place the only possible solution to alligatoring is to perform a full-depth patch.



Fig. Alligator Cracking

### **Block Cracking**

Block cracks look like large interconnected rectangles (roughly). Block cracking is not load-associated, but generally caused by shrinkage of the asphalt pavement due to an inability of asphalt binder to expand and contract with temperature cycles. This can be because the mix was mixed and placed too dry; Fine aggregate mix with low penetration asphalt & absorptive aggregates; poor choice of asphalt binder in the mix design; or aging dried out asphalt.

FIX: Less severe cracks measuring 1/2 inch or less can be sealed to prevent moisture from entering into the sub grade. More severe cracks should be fixed by removing the cracked pavement layer and replacing it with an overlay.



Fig. Block Cracking

### **Longitudinal (Linear) Cracking**

Longitudinal cracking are cracks that are parallel to the pavements centerline or laydown direction. These can be a result of both pavement fatigue, reflective cracking, and/or poor joint construction. Joints are generally the least dense areas

of a pavement.

**FIX:** Less severe cracks measuring 1/2 inch or less can be sealed to prevent moisture from entering into the sub grade. More severe cracks should be fixed by removing the cracked pavement layer and replacing it with an overlay.



Longitudinal (Linear) Cracking

### **Transverse Cracking**

Transverse cracks are single cracks perpendicular to the pavement's centerline or laydown direction. Transverse cracks can be caused by reflective cracks from an underlying layer, daily temperature cycles, and poor construction due to improper operation of the paver.

**FIX:** Less severe cracks measuring 1/2 inch or less can be sealed to prevent moisture from entering into the sub grade. More severe cracks should be fixed by removing the cracked pavement layer and replacing it with an overlay.



Fig. Transverse Cracking

### **Edge Cracks**

Edge Cracks travel along the inside edge of a pavement surface within one or two feet. The most common cause for this type of crack is poor drainage conditions and lack of support at the pavement edge. As a result underlying base

materials settle and become weakened. Heavy vegetation along the pavement edge and heavy traffic can also be the instigator of edge cracking.

**FIX:** The first step in correcting the problem is to remove any existing vegetation close to the edge of the pavement and fix any drainage problems. Crack seal/fill the cracks to prevent further deterioration or remove and reconstruct to full depth fixing any support issues.



Fig. Edge Cracks

### **Joint Reflection Cracks**

These are cracks in a flexible pavement overlay of a rigid pavement (i.e., asphalt over concrete). They occur directly over the underlying rigid pavement joints. Joint reflection cracking does not include reflection cracks that occur away from an underlying joint or from any other type of base (e.g., cement or lime stabilized).

**FIX:** For less severe cracks (less than 1/2 inch) crack sealing will prevent the further entry of moisture into the subgrade. If the cracks are more severe the removal of the cracked pavement layer followed by an overlay may be required.



Fig. Joint Reflection Cracks

### Slippage Cracks

Slippage cracks are crescent-shaped cracks or tears in the surface layer(s) of asphalt where the new material has slipped over the underlying course. This problem is caused by a lack of bonding between layers. This is often because a tack coat was not used to develop a bond between the asphalt layers or because a prime coat was not used to bond the asphalt to the underlying stone base course. The lack of bond can be also caused by dirt, oil, or other contaminants preventing adhesion between the layers.

FIX: All of the areas exhibiting the “stretch marks” will need to be removed and will require a partial or full depth patch.



Fig. Slippage Cracks

### Pot Holes

Small, bowl-shaped depressions in the pavement surface that penetrate all the way through the asphalt layer down to the base course. They generally have sharp edges and vertical sides near the top of the hole. Potholes are the result of moisture infiltration and usually the end result of untreated alligator cracking. As alligator cracking becomes severe, the interconnected cracks create small chunks of pavement, which can be dislodged as vehicles drive over them. The remaining hole after the pavement chunk is dislodged is called a pothole.

FIX: Full depth replacement patch.



Fig. Pot Holes

### Depressions (bird baths)

Depressions are localized pavement surface areas with slightly lower elevations than the surrounding pavement. Depressions are very noticeable after a rain when they fill with water.

FIX: Depending on the severity of the depression the asphalt may have to be removed and replaced (severe). Less severe depressions can be fixed by applying a thin surface patch or infrared patch.



Fig. Depressions (bird baths)

### Rutting

Ruts in asphalt pavements are channelized depressions in the wheel-tracks. Rutting results from consolidation or lateral movement of any of the pavement layers or the subgrade under traffic. It is caused by insufficient pavement thickness; lack of compaction of the asphalt, stone base or soil; weak asphalt mixes; or moisture infiltration.

FIX: If rutting is minor or if it has stabilized, the depressions can be filled and overlaid. If the deformations are severe, the rutted area should be removed and replaced with suitable material.

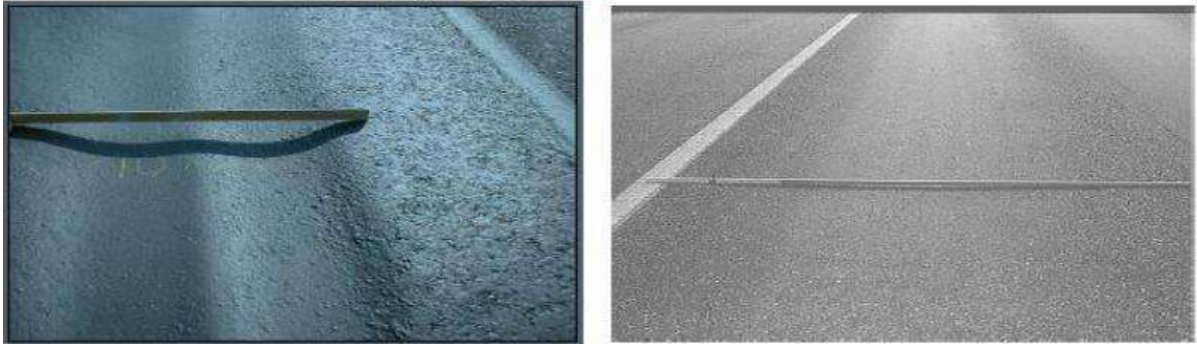

Fig. Rutting

## Shoving

Shoving is the formation of ripples across a pavement. This characteristic shape is why this type of distress is sometimes called wash-boarding. Shoving occurs at locations having severe horizontal stresses, such as intersections. It is typically caused by: excess asphalt; too much fine aggregate; rounded aggregate; too soft an asphalt; or a weak granular base.

FIX: Partial or full depth patch



Fig. Shoving

## Upheaval

Upheaval is a localized upward movement in a pavement due to swelling of the subgrade. This can be due to expansive soils that swell due to moisture or frost heave (ice under the pavement).

FIX: Full depth patch





Fig. Upheaval

### **Raveling (very porous asphalt)**

Raveling is the on-going separation of aggregate particles in a pavement from the surface downward or from the edges inward. Usually, the fine aggregate wears away first and then leaves little “pock marks” on the pavement surface. As the erosion continues, larger and larger particles are broken free and the pavement soon has the rough and jagged appearance typical of surface erosion. There are many reasons why raveling can occur, but one common cause is placing asphalt too late in the season. This is because the mixture usually lacks warm weather traffic which reduces pavement surface voids, further densification, and kneading of the asphalt mat. For this reason raveling is more common in the more northern regions(snow belt).

**FIX:** Apply a thin hot-mix overlay. Other solutions could include: sand seal, chip seal, slurry seal or micro-surfacing.



Fig. Raveling (very porous asphalt)

### **Other issues that need treatment before maintenance:**

**Oil Spots** – oil spots are a common problem in parking lots and driveways. These areas must be treated before sealcoating or the oil and chemicals will seep up through the newly applied material and render your sealed surface ineffective. There are number of great products for treating these types of issues. Ask your material supplier what they offer.

**Grass** – Poorly maintained parking lots will often have grass growing up through the cracks. Cleaning the cracks should be standard practice before sealing them. Use a heat lance to burn out the crack and/or blow out the cracks depending on the severity of the problem.

**Mud, tree sap, berry stains, etc** – Anything that would sit between the asphalt and the sealer must be removed. Without removing it the sealer can not properly adhere to the asphalt and will eventually (sooner than later most likely) peel off. Blowers, push brooms, pressure washers, and gas powered brooms are all tools you should have in your pavement maintenance arsenal.

### **Maintenance of bituminous road such as patch work and resurfacing**

In addition to standard causes such as traffic, weather and ingress of water for the deterioration of earth, gravel and WBM roads, loss of volatiles, oxidation of the binder material and inadequacy of the specification and construction

standards also could be the reasons for distress and disintegration of bituminous pavements.

**Depending upon the degree of deterioration of the highway facility, the nature of the maintenance operations for bituminous pavements could be:**

- (a) Patch repair
- (b) Surface treatment
- (c) Resurfacing

**(a) Patch Repair:**

This consists of patching up of pot-holes and localised failures, and may be up to about 25 per cent of the surface area annually. For patching, sand premix, open-grade premix, dense-graded premix, or penetration patching may be adopted.

**(b) Surface Treatment:**

The aim of surface treatment may be renewal of the surface course when patch repair becomes uneconomical; it may also be to improve skid resistance when the surface is worn out badly. Standard specifications for tack coat, prime coat and seal coat, along with surface dressing/premix carpet should be used.

**(c) Resurfacing:**

This is taken up when the pavement has deteriorated badly. When the pavement is of inadequate thickness, an 'overlay' of adequate thickness should be designed and provided.

A brief description of the defects, symptoms, probable causes, and possible treatment is given in the Table 10.3, extracted from "IRC; 82-1982: 'Code of Practice for maintenance of bituminous surfaces', Indian Roads Congress, New Delhi, 1982": Defects, Symptoms, Causes and Treatment of Defects in Bituminous Surfacing.

**Table 10.3** Defects, symptoms, causes and treatment of defects in bituminous surfacings

Type of defect	Symptoms	Probable causes	Possible treatment
A. Surface defect			
1. Fatty surface	Collection of binder on the surface	Excessive binder; loss of cover aggregates excessively heavy axle load.	Sand-blinding; open-graded premix; liquid seal coat; removal of affected area.
2. Smooth surface	Slippery	Polishing of aggregates under traffic; or excessive binder	Resurfacing with surface dressing or premix carpet.
B. Cracks	Interconnected cracks forming a series of small blocks	Weak pavement, poor subgrade, excessive loads, or brittle binder	The treatment depends on whether the pavement is structurally sound or unsound.
1. Alligator cracks			For structurally sound condition, cracks are to be filled with low viscosity binder. Unsound cracked pavement need strengthening or rehabilitation treatment.
2. Longitudinal cracks	Cracks on a straight line along the road.	Poor drainage, shoulder settlement, or differential frost-heave	
3. Shrinkage cracks	Cracks in transverse direction or interconnected cracks forming large blocks	Shrinkage of bituminous layer with age.	
C. Deformation	Longitudinal depression in the wheel tracks	Heavy channelized traffic inadequate compaction or heavy steel-tired traffic	Filling the depressions with premix material
1. Rutting			
2. Corrugations	Formation of regular undulations	Lack of mix stability, oscillations from vehicle spring, faulty laying of surface course	Scarification and relaying of surface.
3. Settlement	Large deformation of pavement	Poor compaction of fills, poor drainage, inadequate pavement or frost heave	Where fill is weak, it should be replaced. If pavement is inadequate, it should be strengthened.
D. Disintegration	Separation of bitumen from aggregates in the presence of moisture	Use of hydrophilic aggregate, poor mix, continuous contact with water	Spreading and compacting heated sand, replacement with fresh bituminous mix
1. Stripping			
2. Loss of aggregate	Rough surface with loss of aggregate in some portions	Ageing and hardening of binder, poor bond between aggregate and binder, poor compaction	Application of liquid seal, fog seal or slurry seal depending upon the extent of damage.
3. Ravelling	Failure of binder to hold the aggregates with small eroded areas on the surface.	All the above and insufficient binder, and brittleness of binder	Application of cutback covered with coarse sand, or a premix renewal coat.
4. Pot-holes	Appearance of bowl-shaped holes, usually after rain.	Ingress of water into the pavement, lack of bond between WBM base and surfacing, insufficient bitumen content.	Filling pot-holes with premix material or penetration patching.

Renewal of surface is needed every 4 to 5 years for national and state highways.

The renewal can be with metal (75 mm), surfacing dressing, premix chipping carpet with seal coat, semi-dense bituminous concrete, or bituminous concrete.

**Maintenance of concrete roads – filling cracks, repairing joints, maintenance of shoulders (berm), maintenance of traffic control devices**

A cement concrete pavement needs very little maintenance if it is well-designed and properly constructed. In fact, this is considered to be the most important advantage which offsets the high initial cost. However, defects are likely to occur due to ingress of water, especially through ill-maintained joints and cracks, inadequate pavement thickness and poor workmanship.

**Cracks:**

Appearance of cracks, which may be shrinkage cracks or warping cracks due to temperature changes.

Cracks which appear in the corner and edge regions are called 'structural cracks' as they are due to the excessive stresses caused by wheel loads. They indicate inadequacy of the pavement thickness and should be viewed seriously and treated differently.

Hair cracks are not harmful, but medium and wide cracks allow water to seep through and cause progressive loss of subgrade support. Such cracks should be filled up with low-viscosity epoxy grout, after cleaning the cracks of dust. Compressed air is used for effective cleaning. The material is topped up with sand or fine aggregate chips to prevent the disturbance of the material under traffic.

**Joints:**

Joint maintenance consists of replenishing lost sealant, removal of deteriorated joint filler, and introduction of fresh filler material. The sealant is then poured to an excess height of about 3 mm and sand sprinkled for it to be compressed by the traffic to the level of the pavement surface.

**Patch Repair of Slabs:**

Sealing, spalling, depressions and irregularities can occur in a slab locally. Immediate patching up of such defective slabs can arrest further deterioration.

Premix bituminous materials are commonly used for this purpose, but they do not provide a satisfactory result. The best materials are epoxy resin mortars and concrete for such patch repair work. The sides of the area of the slab to be patched are trimmed, made vertical, and fresh concrete is laid and tamped; the areas are usually made of regular geometrical shapes like rectangles.

**Mud-Pumping:**

When water gets collected in the subgrade, heavy axle loads cause ejection of mud through joints, cracks and edges. This phenomenon is commonly known as mud-pumping and blowing. When this is observed, defective joints and wide cracks should be refilled and sealed.

To prevent further damage and recurrence, grouting of the slab is done through holes drilled in it; the grout can be of cement mortar (1:3.5 mix) or of

bituminous material (the latter is preferred since it is effective in filling the void spaces between the slab and the subgrade), and raising the slab to the desired level. This process is called mud-jacking and is popularly used in advanced countries.

### **Restoration of Anti-Skid Surface:**

When the surface becomes smooth and slippery, anti-skid surface can be restored by cutting grooves by grooving machines or by grinding machines.

### **Crack Repair:**

A patching mix of epoxy mortar can be filled and compacted after chipping off the area and cleaning it thoroughly by using compressed air. This is adequate only when the crack depth is not more than one-third of the depth of the slab.

However, when the crack extends almost to the entire depth of the slab, cross-stitching with inclined tie-bars or stapling with U-bars may be adopted; the former is shown schematically in Fig. 10.9.

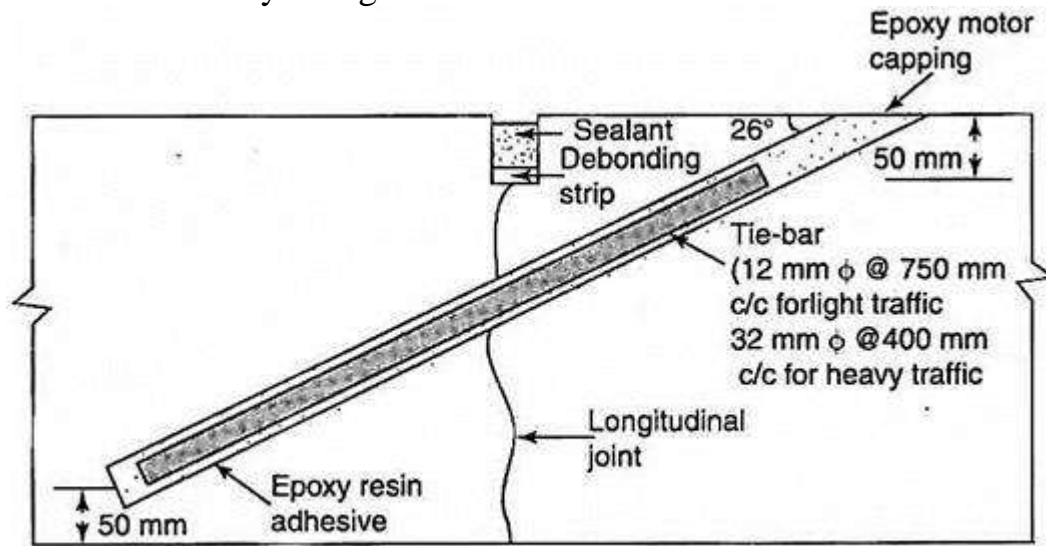

**FIG. 10.9** Crack repair by cross-stitching

### ***Mechanised Maintenance of Roads:***

In India, road maintenance is mostly labour-oriented; however, mechanical maintenance of roads also can be practised with indigenous equipment for speedy implementation and better quality control.

### ***Maintenance Management System (MMS):***

In view of the several steps and factors involved in the maintenance operations of highways, systems approach is considered desirable to evolve an efficient maintenance programme for any highway network.

A computer package known as 'Pavement Management System' has been formulated to facilitate optimal resource allocation for maintenance.

**The elements in this are:**

- a. Basic road data bank
- b. Pavement performance model
- c. Selection of maintenance levels
- d. Evolving priorities for maintenance (renewal and overlay) for a given budget.

Several organisations have developed their own MMS packages and implemented them in their respective countries.

### **Basic concept of traffic study, Traffic safety and traffic control signal**

Traffic studies are carried out to analyze the traffic characteristics. These studies helps in deciding the geometric design features traffic control for safe and efficient traffic movement.

The various traffic survey studies generally carried out are:

- Traffic volume study
- Speed study
- Spot speed study
- Speed and delay study
- Origin and destination study
- Traffic flow characteristics
- Traffic capacity study
- Parking study
- Accident studies

### **Traffic Volume Study**

- It is the number of vehicles crossing a section of road per unit time at any selected period.
- It is used as a quantity measure of flow: the commonly units are vehicles/day or vehicles/hour

### **Object and Uses of Traffic Volume Study:**

- It is generally accepted as a true measure of the relative importance of roads and in deciding the priority for improvement and expansion.
- It is used in planning, traffic operation and control of existing facilities and also for planning the new facilities.
- It is used in the analysis of traffic patterns and trends.
- Useful in structural design of pavement
- Pedestrian traffic volume study is used for planning side walk, Crosswalks, subway and pedestrian signals.

### **Speed study**

#### **Spot Speed**

Instantaneous speed of a vehicle at a specified location.

#### **Average Speed**

Average of the spot speeds of all vehicles passing a given point on the highway.

### **Running Speed**

Average speed maintained by a vehicle over a given course while the vehicle is in motion.

$$\begin{aligned} \text{Running speed} &= \text{Length of course} / \text{Running time} \\ &= \text{Length of course} / (\text{Journey time} - \text{Delays}) \end{aligned}$$

### **Journey speed**

- Also known as overall travel speed
- It is the effective speed between two points. It is the distance between two points divided by the total time taken by the vehicle to complete the journey, including all delays.
- Journey speed = Distance / Total journey Time (including Delays).

### **Spot speed study**

The methods available for measuring spot speed can be grouped as

Those observations that require time taken by a vehicle to cover a known distance.

It consist of

- long base methods- vehicles are timed over a long distance.
- Short base methods- vehicles are timed over a Short distance, say about 2m.
- Radar Speedometer which automatically records instantaneous speed.
- Photographic method.

### **Speed and delay study**

- The Speed and delay study give the running speed, overall speed, fluctuation in speeds and the delay between two station of a road.
- It gives the information such as the amount, location, duration and cause of delay in the traffic stream.
- The result of spot and delay studies are useful in detecting spot of congestion.
- The delay or time lost traffic during the travel period be either due to fixed delays or operational delays.
- Fixed delay occurs primarily at intersections due to the signals and at level crossings.
- Operational delays are caused by the interference of movement, such as turning vehicles, parking vehicles, pedestrians etc.

Various methods to carry out speed and delay survey are:

1. Floating Car method
2. Licence Plate record method
3. By Interview



#### 4. By Photography and videography

##### **Origin and destination study**

In a transportation study, it is often necessary to know the exact origin and destination of the trips. The information yielded by O-D survey includes land-use of the zones of origin and destination, household characteristics of the trip making family, time of the day when journeys are made, trip purpose and mode of travel.

- Origin is defined as the place where the trip begins and destination is defined as the place where the trip ends.
- Origin-Destination (OD) studies are an important tool for transportation Professionals. OD studies are conducted to understand the pattern of the movement of Persons and goods in a particular area of interest during a particular period of time (Wang, 1997).
- The origin and destination study is Carried out mainly to know the origin and destination of various vehicles .
- In this study the data collected are, Number of vehicles, their origin and Destination number of passengers in Each vehicle, route etc.

##### **Parking study**

One of the problems created by road traffic is parking. Not only do vehicles require street space to move about, but also do they require space to park where the occupants can be loaded and unloaded. The period over which a car is parked is very great compared with the time it is in motion. Every car owner would wish to park the car as closely as possible to his destination so as to minimize his walking.

- Traveling vehicles at one time or another will need to park for short or long times.
- Need for parking spaces is great in areas where land uses include (business, residential, or commercial).
- In high density areas spaces are very expensive, thus the space provided for automobiles usually has to be divided between their movement and parking.

##### **Accident studies**

Road accident can not be totally prevented, but by suitable traffic engineering and management measures, the accident rate can be decreased considerably. The various objectives of the accident studies may be listed as :

- To study the cause of accident and to suggest corrective treatment at potential location.
- To elaluate the existing.
- To support proposed design.
- To carry out studies before and after for improvement
- To make financial computation and to give economic justification for the improvements suggested by the traffic engineer.

## Causes of Accidents

- The road user
- The vehicles
- The road and its condition.
- Environmental factors
- Other causes-incorrect signs and signals, gate of level crossing, badly located advertized boards etc.

**1. Road Users** - Excessive speed and rash driving, violation of traffic rules, failure to perceive traffic situation or sign or signal in adequate time, carelessness, fatigue, alcohol, sleep etc.

**2. Vehicle** - Defects such as failure of brakes, steering system, tyre burst, lighting system .

**3. Road Condition** - Skidding road surface, pot holes, ruts.

**4. Road design** - Defective geometric design like inadequate sight distance, inadequate width of shoulders, improper curve design, improper traffic control devices and improper lighting.

**5. Environmental factors** –Unfavorable weather conditions like mist, snow, smoke and heavy rainfall which restrict normal visibility and makes driving unsafe.

**6. Other causes** -improper location of advertisement boards, gate of level crossing not closed when required etc..

## Prevention of road accident

- Strict punishment should be enforced by govt. if a person drives in over speed
- Tamper proof speed controllers should be installed in all vehicles.
- Two wheelers should not exceeded 50-70km/h.
- All the rules should be followed properly by the people.

## Traffic safety and traffic control signal

Traffic control device is the medium used for communicating between traffic engineer and road users. Unlike other modes of transportation, there is no control on the drivers using the road. Here traffic control devices comes to the help of the traffic engineer. The major types of traffic control devices used are- traffic signs, road markings , traffic signals and parking control.

Types of traffic control Devices are as follows.

- Signs
- Signals
- Markings
- Islands

## Requirements of traffic control devices

1. **The control device should fulfil a need** : Each device must have a specific purpose for the safe and efficient operation of traffic flow. The superfluous devices should not be used.
2. **It should command attention from the road users:** This affects the design of signs. For commanding attention, proper visibility should be

- there. Also the sign should be distinctive and clear. The sign should be placed in such a way that the driver requires no extra effort to see the sign.
3. **It should convey a clear, simple meaning:** Clarity and simplicity of message is essential for the driver to properly understand the meaning in short time. The use of colour, shape and legend as codes becomes important in this regard. The legend should be kept short and simple so that even a less educated driver could understand the message in less time.
  4. **Road users must respect the signs:** Respect is commanded only when the drivers are conditioned to expect that all devices carry meaningful and important messages. Overuse, misuse and confusing messages of devices tends the drivers to ignore them.
  5. **The control device should provide adequate time for proper response from the road users:** This is again related to the design aspect of traffic control devices. The sign boards should be placed at a distance such that the driver could see it and gets sufficient time to respond to the situation. For example, the STOP sign which is always placed at the stop line of the intersection should be visible for atleast one safe stopping sight distance away from the stop line.

### **Communication tools**

A number of mechanisms are used by the traffic engineer to communicate with the road user. These mechanisms recognize certain human limitations, particularly eyesight. Messages are conveyed through the following elements.

1. **Colour:** It is the first and most easily noticed characteristics of a device. Usage of different colours for different signs are important. The most commonly used colors are red, green, yellow, black, blue, and brown . These are used to code certain devices and to reinforce specific messages. Consistent use of colours helps the drivers to identify the presence of sign board ahead.
2. **Shape :** It is the second element discerned by the driver next to the colour of the device. The categories of shapes normally used are circular, triangular, rectangular, and diamond shape. Two exceptional shapes used in traffic signs are octagonal shape for STOP sign and use of inverted triangle for GIVE WAY (YIELD) sign. Diamond shape signs are not generally used in India.
3. **Legend :** This is the last element of a device that the drive comprehends. This is an important aspect in the case of traffic signs. For the easy understanding by the driver, the legend should be short, simple and specific so that it does not divert the attention of the driver. Symbols are normally used as legends so that even a person unable to read the

language will be able to understand that. There is no need of it in the case of traffic signals and road markings.

4. **Pattern:** It is normally used in the application of road markings, complementing traffic signs. Generally solid, double solid and dotted lines are used. Each pattern conveys different type of meaning. The frequent and consistent use of pattern to convey information is recommended so that the drivers get accustomed to the different types of markings and can instantly recognize them.

### **Types of traffic signs**

There are several hundreds of traffic signs available covering wide variety of traffic situations. They can be classified into three main categories.

1. **Regulatory signs:** These signs require the driver to obey the signs for the safety of other road users.
2. **Warning signs:** These signs are for the safety of oneself who is driving and advice the drivers to obey these signs.
3. **Informative signs:** These signs provide information to the driver about the facilities available ahead, and the route and distance to reach the specific destinations

In addition special type of traffic sign namely *work zone signs* are also available. These type of signs are used to give warning to the road users when some construction work is going on the road. They are placed only for short duration and will be removed soon after the work is over and when the road is brought back to its normal condition. The first three signs will be discussed in detail below.

### **Regulatory signs**

These signs are also called mandatory signs because it is mandatory that the drivers must obey these signs. If the driver fails to obey them, the control agency has the right to take legal action against the driver. These signs are primarily meant for the safety of other road users. These signs have generally black legend on a white background. They are circular in shape with red borders. The regulatory signs can be further classified into :

1. **Right of way series:** These include two unique signs that assign the right of way to the selected approaches of an intersection. They are the STOP sign and GIVE WAY sign For example, when one minor road and major road meets at an intersection, preference should be given to the vehicles passing through the major road. Hence the give way sign board will be placed on the minor road to inform the driver on the minor road that he should give way for the vehicles on the major road. In case two major roads are meeting, then the traffic engineer decides based on the traffic on which approach the sign board has to be placed. Stop sign is another

example of regulatory signs that comes in right of way series which requires the driver to stop the vehicle at the stop line.

2. **Speed series:** Number of speed signs may be used to limit the speed of the vehicle on the road. They include typical speed limit signs, truck speed, minimum speed signs etc. Speed limit signs are placed to limit the speed of the vehicle to a particular speed for many reasons. Separate truck speed limits are applied on high speed roadways where heavy commercial vehicles must be limited to slower speeds than passenger cars for safety reasons. Minimum speed limits are applied on high speed roads like expressways, freeways etc. where safety is again a predominant reason. Very slow vehicles may present hazard to themselves and other vehicles also.
3. **Movement series:** They contain a number of signs that affect specific vehicle maneuvers. These include turn signs, alignment signs, exclusion signs, one way signs etc. Turn signs include turn prohibitions and lane use control signs. Lane use signs make use of arrows to specify the movements which all vehicles in the lane must take. Turn signs are used to safely accommodate turns in unsignalized intersections.
4. **Parking series:** They include parking signs which indicate not only parking prohibitions or restrictions, but also indicate places where parking is permitted, the type of vehicle to be parked, duration for parking etc.
5. **Pedestrian series:** They include both legend and symbol signs. These signs are meant for the safety of pedestrians and include signs indicating pedestrian only roads, pedestrian crossing sites etc.
6. **Miscellaneous:** Wide variety of signs that are included in this category are: a "KEEP OF MEDIAN" sign, signs indicating road closures, signs restricting vehicles carrying hazardous cargo or substances, signs indicating vehicle weight limitations etc.

Some examples of the regulatory signs are shown in figure . They include a stop sign, give way sign, signs for no entry, sign indicating prohibition for right turn, vehicle width limit sign, speed limit sign etc.



Fig. Examples of regulatory signs ( stop sign, give way sign, signs for no entry, sign indicating prohibition for right turn, vehicle width limit sign, speed limit sign)

### Warning signs

Warning signs or cautionary signs give information to the driver about the impending road condition. They advise the driver to obey the rules. These signs are meant for the own safety of drivers. They call for extra vigilance from the part of drivers. The colour convention used for this type of signs is that the legend will be black in colour with a white background. The shape used is upward triangular or diamond shape with red borders. Some of the examples for this type of signs are given in fig. and includes right hand curve sign board, signs for narrow road, sign indicating railway track ahead etc.

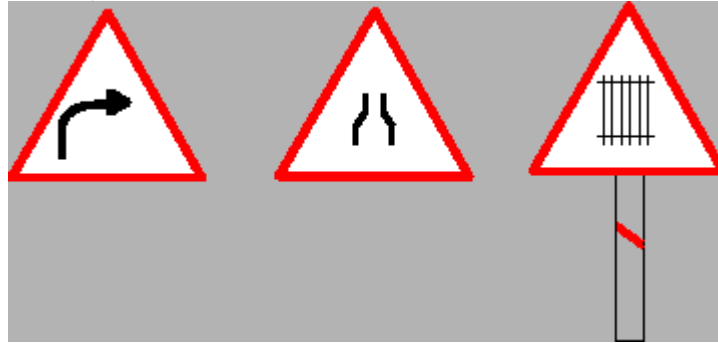

Fig. Examples of cautionary signs ( right hand curve sign board, signs for narrow road, sign indicating railway track ahead)

### Informative signs

Informative signs also called guide signs, are provided to assist the drivers to reach their desired destinations. These are predominantly meant for the drivers who are unfamiliar to the place. The guide signs are redundant for the users who are accustomed to the location.

Some of the examples for these type of signs are route markers, destination signs, mile posts, service information, recreational and cultural interest area signing etc. Route markers are used to identify numbered highways. They have designs that are distinctive and unique. They are written black letters on yellow background. Destination signs are used to indicate the direction to the critical destination points, and to mark important intersections. Distance in kilometers are sometimes marked to the right side of the destination. They are, in general, rectangular with the long dimension in the horizontal direction. They are color coded as white letters with green background.

Mile posts are provided to inform the driver about the progress along a route to reach his destination. Service guide signs give information to the driver regarding various services such as food, fuel, medical assistance etc. They are written with white letters on blue background. Information on historic, recreational and other cultural area is given on white letters with brown background. In the figure we can see some examples for informative signs which include route markers, destination signs, mile posts, service centre information etc.

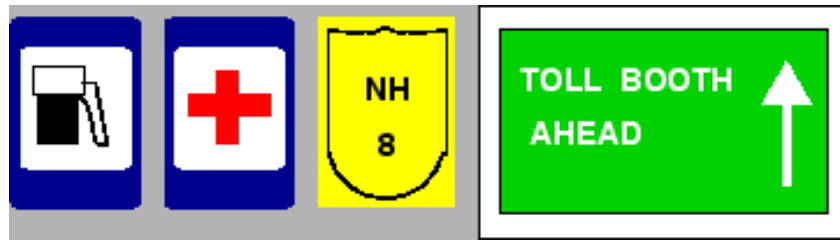

Fig. Examples of informative signs (route markers, destination signs, mile posts, service centre information etc)

### Traffic signals

They are control devices which could alternately direct the traffic to stop and proceed at intersections using red and green traffic light signals automatically. The main requirements of requirements of traffic signal are to draw attention , provide meaning and time to respond and to have minimum waste of time.

Types of Traffic Signal-

- Traffic Control Signals
- Pedestrian Signal

**Traffic control signals-** They have three coloured light glows facing each direction of traffic flow.

- RED light means to STOP , GREEN means to GO ,YELLOW or AMBER means allows the CLEARANCE TIME.

**Pedestrian Signals-** They are meant to give the right way to pedestrian to cross a road during the “walk period” when the vehicular traffic shall be stopped by red or stop signal on the traffic signals of the road.



### Road marking

Road marking are made of lines , pattern , words , symbol or reflection on the pavement , kerb , sides of islands or on the fixed objects within or near the roadway.

The markings are made using paints in contrast with colour and brightness of the pavements or other back ground.

Types of marking-

- Pavement Marking
- Kerb Marking
- Object Marking
- Reflector Unit Marking

**1. Pavement Marking-** They may generally be of white paint. Yellow marking are used to indicate parking restrictions .

**2. Kerb Marking-** These may indicate certain regulation like parking regulations. Also the marking on the kerb and edges of islands with alternate black and white line increases the visibility from the a long distance.

**3. Object Marking-** Physical obstruction on or near the road hazardous and hence should be properly marked.

**4. Reflect Unit Marking-** Reflector markers are used as hazard markers and guide markers for safe driving during night. Hazards markers reflecting yellow light should be visible from a long distance of about 150 m.

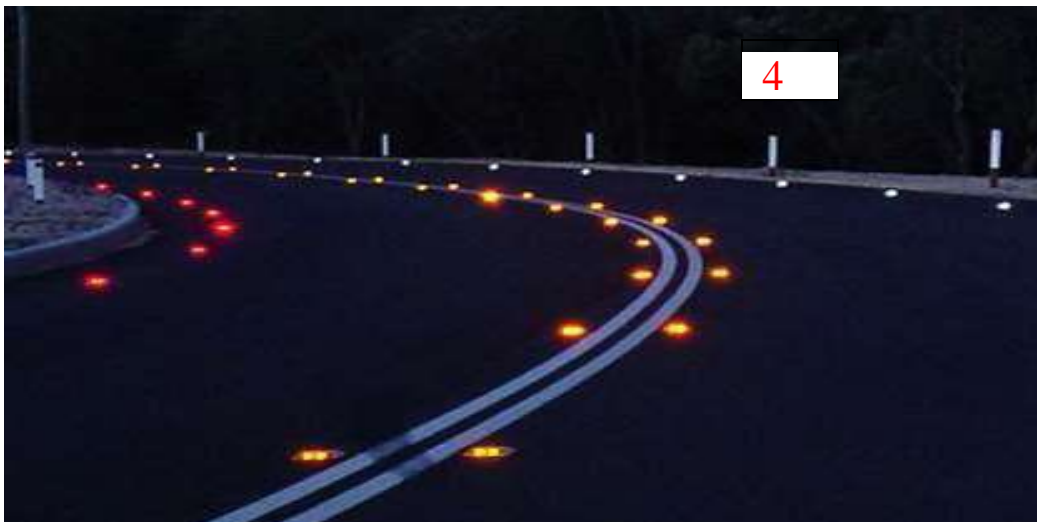
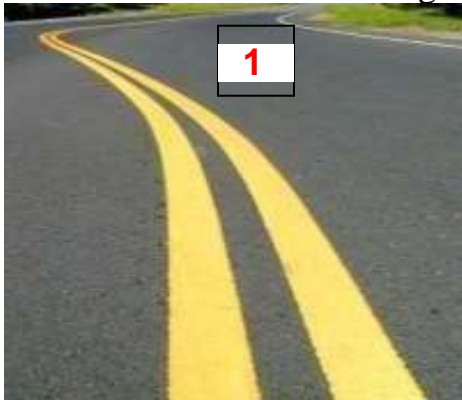

#### Traffic islands

Traffic islands are raised areas constructed within the roadway to establish physical channels through which the vehicular traffic may be guided.

They are mainly four types-

- Divisional Islands



- Channelizing Islands
- Pedestrian Loading Islands
- Rotary Islands

**1.Divisional islands-** They are intended to separate opposing flow of traffic on a highway with four or more lanes . By thus dividing the highway into two one way roadways , the head-on collisions are eliminated.

**2. Channelizing islands-** They are used to guide the traffic into proper channel through the intersection area. They are very useful as traffic control devices for intersection at grades , when area is large.

**3. Pedestrian Loading Islands-** They are provided at regular bus stop and similar places for the protection of passengers.

**4. Rotary islands-** It is the large central island of rotary intersection ; this island is much larger than the central island of channelized intersection.





## CONSTRUCTION EQUIPMENTS

**Preliminary ideas of the following plant and equipment:**

### **Hot mixing plant :**

Asphaltic concrete is a mixture of asphalt, coarse aggregates, fine aggregates & filler material. After mixing, we are heating them up to final product called “HOT MIX”.

There are two basic types of plants used to manufacture hot mix asphalt:

- Batch type plant
- Drum(continuous) type plant

The various parts of Batch mix plant are given below as per flow of material:

1. Cold aggregate four-bin feeder.
2. Cold conveyor.
3. Aggregate dryer.
4. Mixing Chamber
5. Asphalt tank.
6. Mineral filler unit.
7. Load-out conveyor.
8. Centralized control panel.

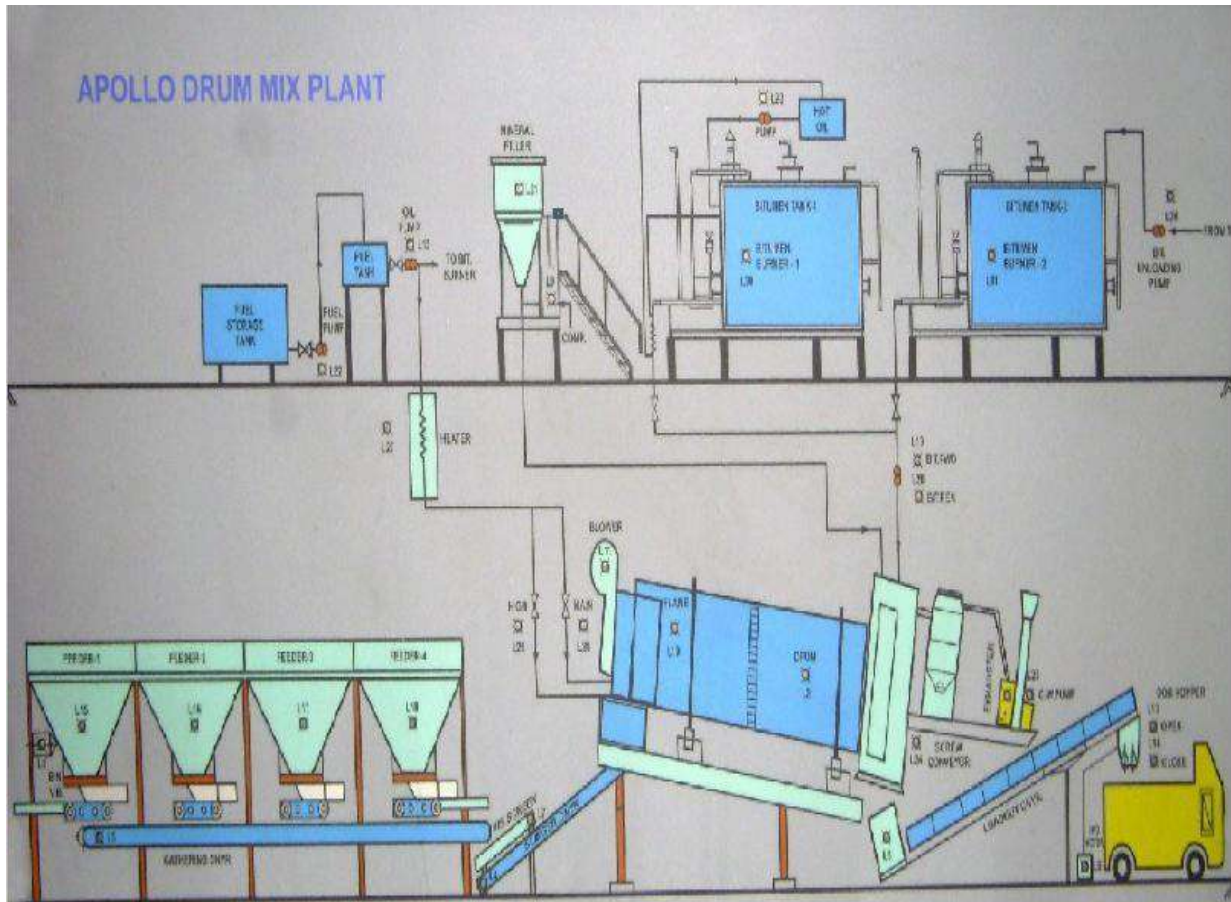

Fig. Schematic Diagram of Drum Mix Plant

### Cold aggregates four – bin feeder: -

1. It consists of FOUR independent top open type bins having being fabricated from MS plate mounted on rigid Channel supported on channel. Each bin consists of an independent and synchronized variable speeds D.C. motor for feeding the aggregates at a predetermined rate through a precisely adjustable bin quadrant gate.
2. Gathering conveyor belt equipped with an electronic weigh bridge and driven by electric motor.
3. Single deck screen provided at the discharge end of the gathering conveyor for rejection of any paver size material above permissible limit.
4. Single main transfer conveyor to receive the aggregates from the gathering conveyor and discharge it into the dryer under the combustion zone driven by electric motor and reduction gear

Separate detachable slinger conveyor is provided to transfer the aggregates received from the vibratory screen to feed into the thermo- drum. Slinger conveyor is driven by constant speed electric motor coupled with reduction gearbox.

The rigid frame of conveyor is fabricated from appropriate channel sections and the conveyor belt is supported by uniformly spaced roller stands. Any sagging on the return travel of the belt is also taken care of by roller.



Fig. Aggregate Dryer

From the cold aggregates conveyor, aggregates are delivered to the dryer. The dryer removes moisture from the aggregates and rises temperature to the desired level.

The dryer has an oil or gas burner with a blower fan to provide the primary air for combustion of the fuel, and an exhaust fan to create a draft through the dryer. Proper aggregate temperature is essential. Aggregates that are heated to an excessive temperature can harden the binder during mixing. Under heated aggregates are difficult to coat thoroughly with binder and the resulting mix is difficult to place on the roadway.



Fig. Mixing Chamber

In this chamber the binder & aggregates are mixed. It consists of a lined mixing chamber with horizontal shaft about which the drum rotates. The chamber is so designed that there are no dead areas formed. The temperature of the mix shall be maintained properly so as to have homogeneous mix.

The whole assembly of Chamber is supported over prefabricated steel sections preferably of channel or I-sections.



Fig. Asphalt Tank

The bitumen section of batch mix plant mainly consists of bitumen tank, bitumen heating burner, bitumen pumping & metering unit and hot oil system.

The tank is fully insulated to minimize heat losses and is of 15,000 liters capacity. The bitumen inside the tank is heated by U-shaped heating tube fitted with automatic burner of adequate capacity. A jacketed bitumen pump driven by variable speed motor through reduction gearbox is provided to pump the bitumen to the drum. The bitumen flow rate is controlled by varying the RPM of motor.

Hot mix storage silos can be offered with options to store different types of mix Designs to meet varied site demands.



Fig.Hot mix storage silo

### **Mineral filler unit:**

The Filler hopper is provided to add mineral filler from a separate hopper, in the mix to the extent pre-selectable in percentage by weight of the maximum plant output.

The unit is fabricated from 5 m thick steel plate and mounted on steel structure.

The system is powered by a variable speed motor coupled with gearbox to rotary valve and also synchronized with aggregate & bitumen output.

The filler material from this unit is conveyed automatically up to coated zone in the pug-mill.



Fig. Mineral filler unit



Fig. Load Out Conveyor

Hot mix material discharged from the pugmill is carried by inclined hot conveyor belt and discharged into the tipper / truck through hydraulically operated surge storage hopper.

Hydraulically operated storage hopper is provided at the discharge end of the conveyor which stores the hot mix and allows it to fall as mass in the batches and thus avoids segregation and spillage during out cycle.

### **CONTROL SYSTEM**

The plant is supplied with centralized control panel. All controls, including the motor control, center circuit breakers are provided in the control panel. The control panel controls feeder bin controls and electric switchgear. All the

parameters like, temperature of bitumen-hot mix material, exhaust gases and aggregate weight, asphalt percentage, hot mix material weight etc. are displayed on the control panel.



Fig. Control Panel

**Tipper, tractors (wheel and crawler) scraper, bulldozer, dumpers, shovels, graders, roller dragline**

### **Tipper**

A truck or lorry the rear platform of which can be raised at the front end to enable the load to be discharged by gravity also called tip truck.

Tipper trucks are suited for the rough and tumble of mining & quarrying operations, as well as for carrying bulk loads in construction and infrastructure industries. Complete manoeuvrability, high performance and long-term endurance are common to all trucks, resulting in lower operating costs.



Fig. Tipper Truck

### **Tractors (Wheel And Crawler)**

Multi-purpose machines used mainly for pulling and pushing the other equipment.

- Tractors may be classified as



a) **Crawler type tractor**- Used to move bull dozers, scrapers. The crawler has a chain by which these tractors can be very effective even in the case of loose or muddy soils. The speed of this type dose not exceed 12 kmph normally.

b) **Wheel type tractor**- The engine is mounted on four wheels. The main advantage is higher speed, sometimes exceeding 50 kmph it is used for long-distance hauling and good roads.



Fig. Crawler type tractor and Wheel type tractor

### Comparison between crawler and wheeled tractors

Crawler type	Wheeled type
1. Slow speed	1. Greater speed
2. More compact and powerful and can handle heavier jobs	2. Con handle only lighter jobs
3. costly	3. cheaper
4. Cost of operation and maintenance is high	4. Operational and maintenance cost is less
5. Stick control for steering	5. Wheel steering control
6. Moves on rough roads only	6. Moves on rough as well as good roads
7. Used for short distances	7.Used for longer distances
8. Requires skillful operation, maintenance and repairs	8. Lesser skills required for operations, maintenance and repairs

## Scraper

- In civil engineering, a wheel tractor-scraper is a piece of heavy equipment used for earthmoving.
- The rear part has a vertically moveable hopper (also known as the bowl) with a sharp horizontal front edge. The hopper can be hydraulically lowered and raised. When the hopper is lowered, the front edge cuts into the soil or clay like a plane and fills the hopper.
- When the hopper is full it is raised, and closed with a vertical blade (known as the apron). The scraper can transport its load to the fill area where the blade is raised, the back panel of the hopper, or the ejector, is hydraulically pushed forward and the load tumbles out. Then the empty scraper returns to the cut site and repeats the cycle.

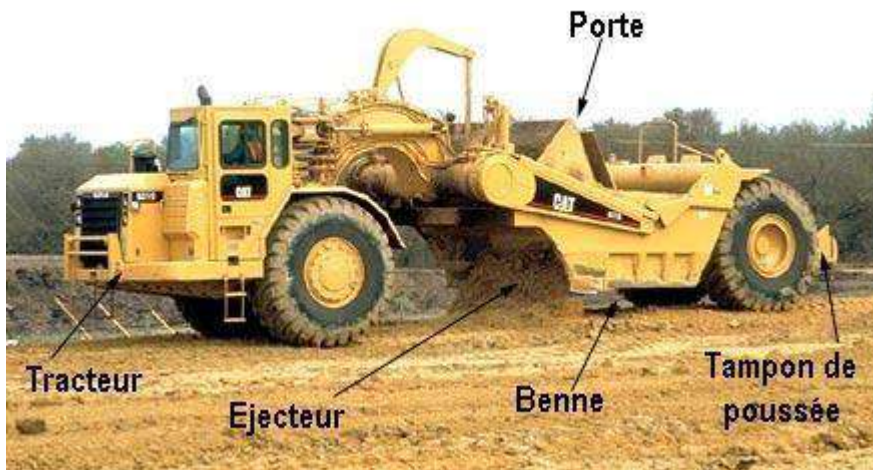

Fig. Scraper

## Bulldozer

A bulldozer is a crawler (continuous tracked tractor) equipped with a substantial metal plate (known as a blade) used to push large quantities of soil, sand, rubble, or other such material during construction or conversion work and typically equipped at the rear with a claw-like device (known as a ripper) to loosen densely-compacted materials.

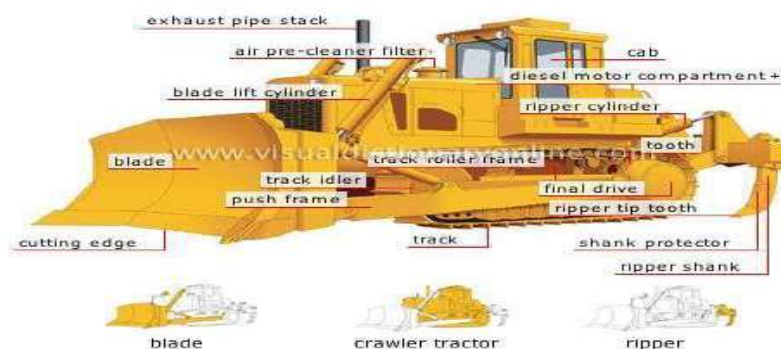
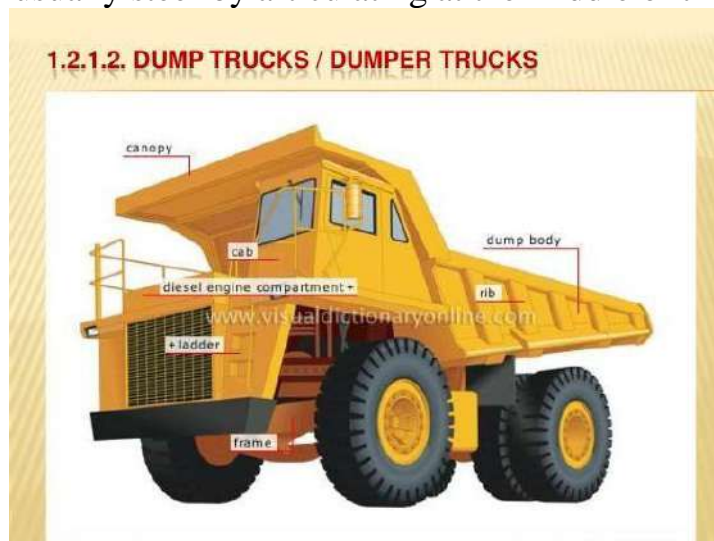

Fig. Bulldozer

## Dumpers

- A dumper is a vehicle designed for carrying bulk material, often on building sites. Dumpers are distinguished from dump trucks by configuration: a dumper is usually an open 4-wheeled vehicle with the load skip in front of the driver, while a dump truck has its cab in front of the load.
- The skip can tip to dump the load; this is where the name "dumper" comes from. They are normally diesel powered. A towing eye is fitted for secondary use as a site tractor. Modern dumpers have payloads of up to 10 tones and usually steer by articulating at the middle of the chassis.



## Shovels

- A power shovel (also stripping shovel or front shovel or electric mining shovel) is a bucket equipped machine, usually electrically powered, used for digging and loading earth or fragmented rock and for mineral extraction.
- Power shovels are used principally for excavation and removal of overburden in open-cut mining operations, though it may include loading of minerals, such as coal. They are the modern equivalent of steam shovels, and operate in a similar fashion.
- A shovel's work cycle, or digging cycle, consists of four phases:
  - Digging
  - Swinging
  - Dumping
  - Returning



Fig. Old Power Shovel



Fig. New Power Shovel

## Graders

- A grader, also commonly referred to as a road grader, a blade, a maintainer, or a motor grader, is a construction machine with a long blade used to create a flat surface.
- Typical models have three axles, with the engine and cab situated above the rear axles at one end of the vehicle and a third axle at the front end of the vehicle, with the blade in between.
- In civil engineering, the grader's purpose is to "finish grade" (refine, set precisely) the "rough grading" performed by heavy equipment or engineering vehicles such as scrapers and bulldozers.
- Graders are commonly used in the construction and maintenance of dirt roads and gravel roads.
- In the construction of paved roads they are used to prepare the base course to create a wide flat surface for the asphalt to be placed on. Graders are also used to set native soil foundation pads to finish grade prior to the construction of large buildings.

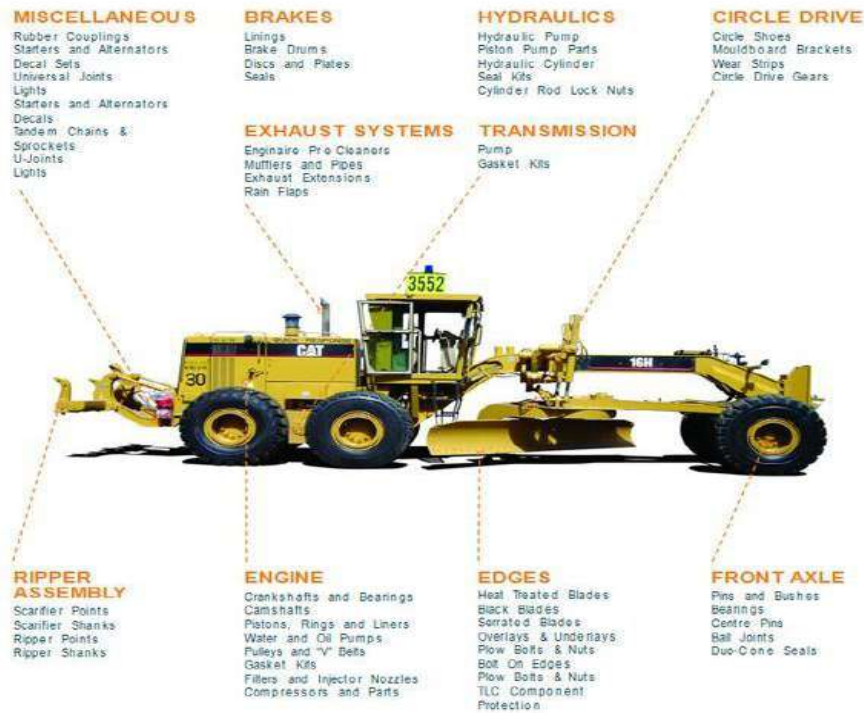

Fig. Grader

## Roller

A road roller (sometimes called a *roller-compactor*, or just *roller*) is a compactor type engineering vehicle used to compact soil, gravel, concrete, or asphalt in the construction of roads and foundations, similar rollers are used also at landfills or in agriculture.



Fig. Roller

## Dragline

- The drag line is so name because of its prominent operation of dragging the bucket against the material to be dug.
- Unlike the shovel, it has a long light crane boom and the bucket is loosely attached to the boom through cables.
- Because of this construction, a dragline can dig and dump over larger distances than a shovel can do.
- Drag lines are useful for digging below its track level and handling softer

materials.

- The basic parts of a drag line including the boom, hoist cable, drag cable, hoist chain, drag chain and bucket.

### Application

- It is the most suitable machine for dragging softer material and below its track level
- It is very useful for excavating trenches when the sides are permitted to establish their angle of repose without shoring.
- It has long reaches.
- It is mostly used in the excavation for canals and depositing on the embankment without hauling units
- It is the most suitable machine for dragging softer material and below its track level
- It is very useful for excavating trenches when the sides are permitted to establish their angle of repose without shoring.
- It has long reaches.
- It is mostly used in the excavation for canals and depositing on the embankment without hauling units.

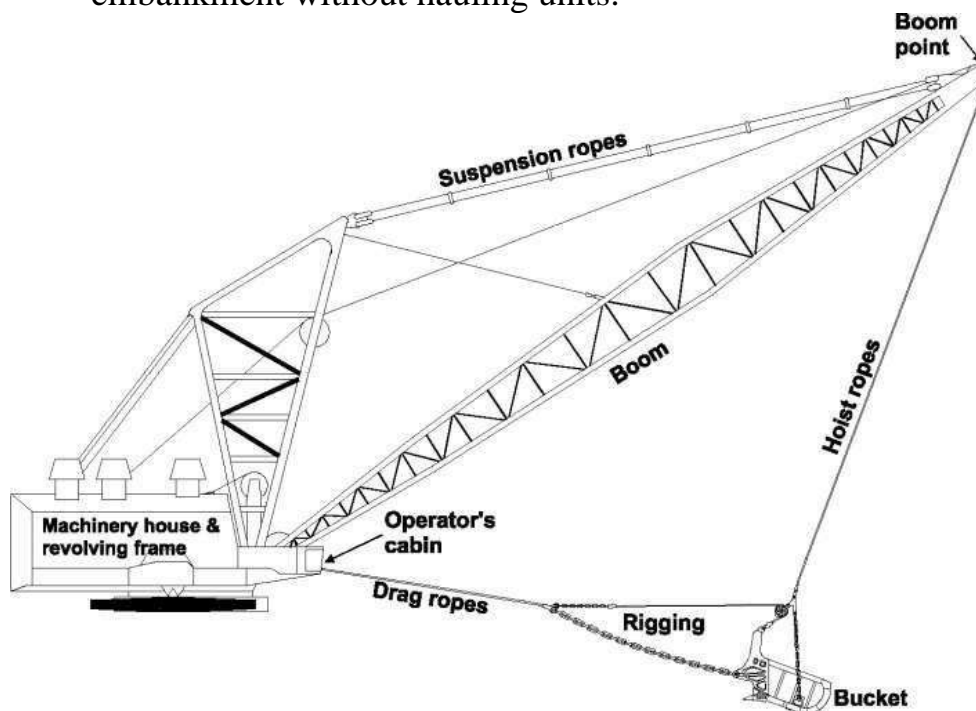

Fig. Dragline

### Road pavers

A paver (paver finisher, asphalt finisher, paving machine) is an engineering vehicle used to lay asphalt on roadways. It is normally fed by a dump truck. A separate machine, a roller, is then used to press the hot asphalt mix, resulting a smooth, even surface. The sub-base being prepared by use of a grader to trim crushed stone to profile after rolling.



Fig. Road Paver

## Modern construction equipments for roads

### Excavators

Excavators are heavy construction equipment consisting of a boom, stick, bucket and cab on a rotating platform (known as the "house").

- The house sits a top an undercarriage with tracks or wheels.
- Excavators are also called diggers
- Excavators are used in many ways:
  - Digging of trenches, holes, foundations
  - Material handling
  - Brush cutting with hydraulic attachments
  - Forestry work
  - Demolition
  - General grading/landscaping
  - Heavy lift, e.g. lifting and placing of pipes
  - Mining, especially, but not only open-pit mining
  - River dredging
  - Driving piles, in conjunction with a pile driver



Fig. Excavator



## Loaders

A loader is a heavy equipment machine often used in construction, primarily used to Load material (such as asphalt, demolition debris, dirt, snow, feed, gravel, logs, raw minerals, recycled material, rock, sand, and woodchips) into or onto another type of machinery (such as a dump truck, conveyor belt, feed hopper, or railcar).



Fig. Loader

## Skid steer loaders

- A skid loader or skid-steer loader is a small rigid frame, engine-powered machine with lift arms used to attach a wide variety of labour-saving tools or attachments.
- Though sometimes they are equipped with tracks, skid steer loaders are typically four wheel vehicles with the wheels mechanically locked in synchronization on each side, and the left-side drive wheels can be driven independently of the right-side drive wheels.



Fig. Skid steer loader

## BACKHOE

- A backhoe, also called a rear actor or back actor, is a piece of excavating equipment or digger consisting of a digging bucket on the end of a two part articulated arm. They are typically mounted on the back of a tractor or front loader.
- The section of the arm closest to the vehicle is known as the boom, and the section which carries the bucket is known as the dipper or dipper stick (the terms "boom" and "dipper" having been used previously on steam shovels). The boom is attached to the vehicle through a pivot known as the kingpost, which allows the arm to slew left and right, usually through a total of around 200 degrees. Modern backhoes are powered by hydraulics.

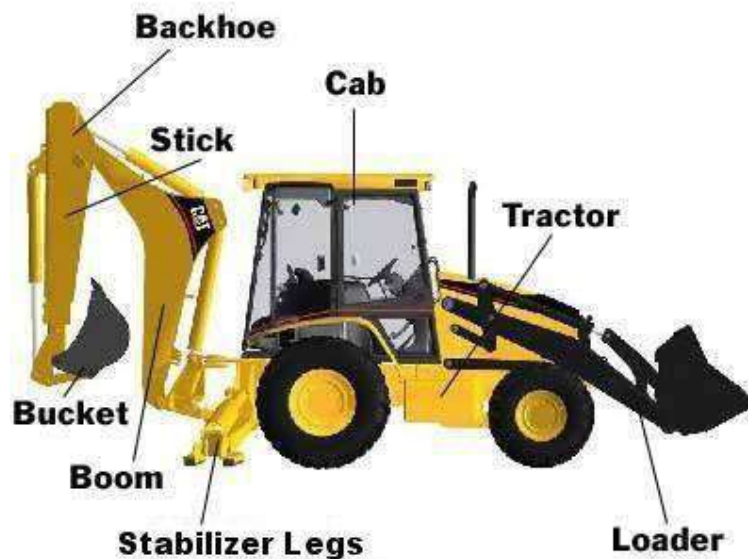

Fig. Backhoe

## Compactors

- A compactor is a machine or mechanism used to reduce the size of waste material or soil through compaction.
- In construction, there are three main types of compactor: the plate compactor, the "Jumping Jack" and the road roller. The roller type compactors are used for compacting crushed rock as the base layer underneath concrete or stone foundations or slabs.
- The plate compactor has a large vibrating base plate and is suited for creating a level grade, while the jumping jack compactor has a smaller foot. The jumping jack type is mainly used to compact the backfill in narrow trenches for water or gas supply pipes etc. Road rollers may also have vibrating rollers.



Fig. Compactor