

Lecture-1

History of Indian Railways

Introduction

In the year 1825 the first Railway running on steam engine, was launched in England.

Thereafter on 1st of August, 1849 the Great Indian Peninsular Railways Company was established in India. On 17th of August 1849, a contract was signed between the Great Indian Peninsular Railways Company and East India Company. As a result of the contract an experiment was made by laying a railway track between Bombay and Thane (56 Kms).

- On 16th April, 1853, the first train service was started from Bombay to Thane.
- On 15th August, 1854, the 2nd train service commenced between Howrah and Hubli.
- On the 1st July, 1856, the 3rd train service in India and first in South India commenced between Vyasarpadi and Walajah Road and on the same day the section between Vyasarpadi and Royapuram by Madras Railway Company was also opened.

Subsequently construction of this efficient transport system began simultaneously in different parts of the Country. By the end of 19th Century 24752 Kms. of rail track was laid for traffic. At this juncture the power, capital, revenue rested with the British. Revenue started flowing through passenger as well as through goods traffic.

Organizational structure

Railway zones

Indian Railways is divided into several zones, which are further sub-divided into divisions. The number of zones in Indian Railways increased from six to eight in 1951, nine in 1952 and sixteen in 2003. Each zonal railway is made up of a certain number of divisions, each having a divisional headquarters. There are a total of sixty-eight divisions. Each of the sixteen zones is headed by a general manager who reports directly to the Railway Board. The zones are further divided into divisions under the control of divisional railway managers (DRM).

Zonal railways details

| Sl. No | Name | Abbr | Date Established | Route km | Headquarters | Divisions |
|--------|-----------------------|------|------------------|----------|--------------|--|
| 1. | Central | CR | 5 November 1951 | 3905 | Mumbai | Mumbai, Bhusawal, Pune, Solapur, Nagpur |
| 2. | East Central | ECR | 1 October 2002 | 3628 | Hajipur | Danapur, Dhanbad, Mughalsarai, Samastipur, Sonpur |
| 3. | East Coast | ECoR | 1 April 2003 | 2677 | Bhubaneswar | Khurda Road, Sambalpur and Waltair (Visakhapatnam) |
| 4. | Eastern | ER | April 1952 | 2414 | Kolkata | Howrah, Sealdah, Asansol, Malda |
| 5. | North Central | NCR | 1 April 2003 | 3151 | Allahabad | Allahabad, Agra, Jhansi |
| 6. | North Eastern | NER | 1952 | 3667 | Gorakhpur | Izzatnagar, Lucknow, Varanasi |
| 7. | North Western | NWR | 1 October 2002 | 5459 | Jaipur | Jaipur, Ajmer, Bikaner, Jodhpur |
| 8. | Northeast Frontier | NFR | 15 January 1958 | 3907 | Guwahati | Alipurduar, Katihar, Rangia, Lumding, Tinsukia |
| 9. | Northern | NR | 14 April 1952 | 6968 | Delhi | Delhi, Ambala, Firozpur, Lucknow, Moradabad |
| 10. | South Central | SCR | 2 October 1966 | 5803 | Secunderabad | Vijayawada, Hyderabad, Guntakal, Guntur, Nanded, Secunderabad |
| 11. | South East Central | SECR | 1 April 2003 | 2447 | Bilaspur | Bilaspur, Raipur, Nagpur |
| 12. | South Eastern | SER | 1955 | 2631 | Kolkata | Adra, Chakradharpur, Kharagpur, Ranchi |
| 13. | South Western | SWR | 1 April 2003 | 3177 | Hubli | Hubli, Bangalore, Mysore |
| 14. | Southern | SR | 14 April 1951 | 5098 | Chennai | Chennai, Trichy, Madurai, Salem,[12] Palakkad, Tiruvananthapuram |
| 15. | West Central | WCR | 1 April 2003 | 2965 | Jabalpur | Jabalpur, Bhopal, Kota |
| 16. | Western | WR | 5 November 1951 | 6182 | Mumbai | Mumbai central, Ratlam, Ahmedabad, Rajkot, Bhavnagar, Vadodara |
| 17. | Kolkata Metro Railway | KNR | 29 December 2010 | | Kolkata | Kolkata |

Subsidiaries of Indian Railways

There also exist independent organisations under the control of the Railway Board for electrification, modernisation, research and design and training of officers, each of which is headed by an officer of the rank of general manager. A number of Public Sector Undertakings, which perform railway-related functions ranging from consultancy to ticketing, are also under the administrative control of the Ministry of railways.

There are fourteen public undertakings under the administrative control of the Ministry of Railways:

- Bharat Wagon and Engineering Co. Ltd. (BWEL)
- Centre for Railway Information Systems (CRIS)^[24]
- Container Corporation of India Limited (CONCOR)
- Dedicated Freight Corridor Corporation of India Limited (DFCCIL)
- Indian Railway Catering and Tourism Corporation Limited (IRCTC)
- Indian Railway Construction (IRCON) International Limited
- Indian Railway Finance Corporation Limited (IRFC)
- Konkan Railway Corporation Limited (KRCL)
- Mumbai Railway Vikas Corporation (MRVC)
- Railtel Corporation of India Limited (Rail Tel)
- Rail India Technical and Economic Services Limited (RITES)
- Rail Vikas Nigam Limited (RVNL)
- High Speed Rail Corporation of India (HSRC)
- Burn Standard Company
- Braithwaite and Co. Ltd

Lecture-2

Component parts of railway track

The Typical components are – Rails, – Sleepers (or ties), – Fasteners, – Ballast (or slab track), – Subgrade

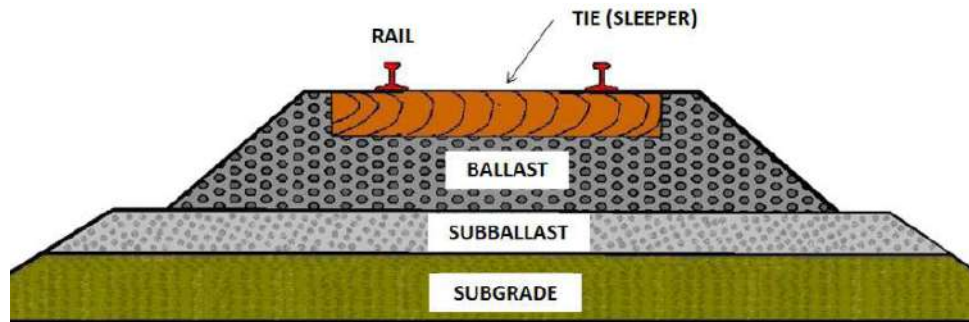

GAUGE

The clear minimum horizontal distance between the inner (running) faces of the two rails forming a track is known as Gauge. Indian railway followed this practice. In European countries, the gauge is measured between the inner faces of two rails at a point 14 mm below the top of the rail.

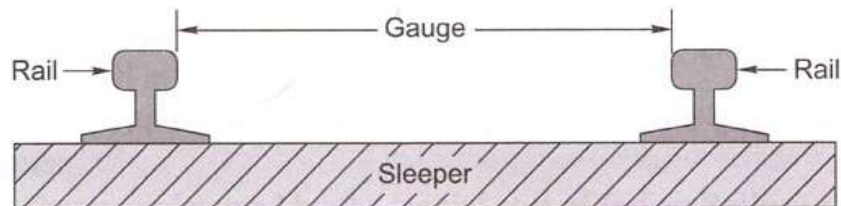

GAUGES ON WORLD RAILWAYS

Various gauges have been adopted by different railways in the world due to historical and other considerations. Initially British Railways had adopted a gauge of 1525 mm (5 feet), but the wheel flanges at that time were on the outside of the rails. Subsequently, in order to guide the wheels better, the flanges were made inside the rails. The gauge then became 1435 mm (4'8.5"), as at that time the width of the rail at the top was 45 mm (1.75 "). The 1435 mm gauge became the standard on most European Railways. The various gauges on world railways are given in Table 2.1.

Various gauges on world railways

| Type of gauge | Gauge (mm) | Gauge (feet) | % of total length | Countries |
|-------------------------|------------------|------------------|-------------------|---|
| Standard gauge | 1435 | 4'8.5" | 62 | England, USA, Canada, Turkey, Persia, and China |
| Broad gauge | 1676 | 5 '6" | 6 | India, Pakistan, Sri Lanka, Brazil, Argentina |
| Broad gauge | 1524 | 5'0" | 9 | Russia, Finland |
| Cape gauge | 1067 | 3 '6" | 8 | Africa, Japan, Java, Australia, and New Zealand |
| Metre gauge | 1000 | 3 '3.5" | 9 | India, France, Switzerland, and Argentina |
| 23 various other gauges | Different gauges | Different gauges | 6 | Various countries |

DIFFERENT GAUGES ON INDIAN RAILWAYS

The East India Company intended to adopt the standard gauge of 1435 mm in India also. This proposal was, however, challenged by W. Simms, Consulting Engineer to the Government of India, who recommended a wider gauge of 1676 mm (5 '6 "). The Court of Directors of the East India Company decided to adopt Simms's recommendation and 5'6 " finally became the Indian standard gauge. In 1871, the Government of India wanted to construct cheaper railways for the development of the country and 1000 mm metre gauge was introduced. In due course of time, two more gauges of widths 762 mm (2 '6 ") and 610 mm (2 '0 ") were introduced for thinly populated areas, mountain railways, and other miscellaneous purposes. The details of the various gauges existing on Indian Railways are given in Table below.

Various gauges on Indian Railways as on 31.03.2011

| Name of gauge | Width (mm) | Route (km) | % of route (km) |
|-------------------|------------|------------|-----------------|
| Broad gauge (BG) | 1676 | 55,188 | 85.6 |
| Metre gauge (MG) | 1000 | 6809 | 10.6 |
| Narrow gauge (NG) | 762 | 2463 | 3.8 |
| | 610 | | |
| Total all gauges | | 64,460 | 100 |

Broad Gauge: - When the clear horizontal distance between the inner faces of two parallel rails forming a track is 1676mm the gauge is called Broad Gauge (B.G)

This gauge is also known as standard gauge of India and is the broadest gauge of the world.

The Other countries using the Broad Gauge are Pakistan, Bangladesh, SriLanka, Brazil, Argentine, etc.50% India's railway tracks have been laid to this gauge.

Suitability: - Broad gauge is suitable under the following Conditions:-

- (i) When sufficient funds are available for the railway project.
- (ii) When the prospects of revenue are very bright.

This gauge is, therefore, used for tracks in plain areas which are densely populated i.e. for routes of maximum traffic, intensities and at places which are centers of industry and commerce.

2. **Metre Gauge:** - When the clear horizontal distance between the inner faces of two parallel rails forming a track is 1000mm, the gauge is known as Metre Gauge (M.G) The other countries using Metre gauge are France, Switzerland, Argentine, etc. 40% of India's railway tracks have been laid to this gauge.

Suitability:- Metre Gauge is suitable under the following conditions:-

- (i) When the funds available for the railway project are inadequate.
- (ii) When the prospects of revenue are not very bright.

This gauge is, therefore, used for tracks in under-developed areas and in interior areas, where traffic intensity is small and prospects for future development are not very bright.

3. **Narrow Gauge:-** When the clear horizontal distance between the inner faces of two parallel rails forming a track is either 762mm or 610mm, the gauge is known as Narrow gauge (N.G) The other countries using narrow gauge are Britain, South Africa, etc. 10% of India's railway tracks have been laid to this gauge.

Suitability: - Narrow gauge is suitable under the following conditions:-

- (i) When the construction of a track with wider gauge is prohibited due to the provision of sharp curves, steep gradients, narrow bridges and tunnels etc.
- (ii) When the prospects of revenue are not very bright. This gauge is, therefore, used in hilly and very thinly populated areas. The feeder gauge is commonly used for feeding raw materials to big government manufacturing concerns as well as to private factories such as steel plants, oil refineries, sugar factories, etc.

CHOICE OF GAUGE

The choice of gauge is very limited, as each country has a fixed gauge and all new railway lines are constructed to adhere to the standard gauge. However, the following factors theoretically influence the choice of the gauge:

Cost considerations

There is only a marginal increase in the cost of the track if a wider gauge is adopted. In this connection, the following points are important

- (a) There is a proportional increase in the cost of acquisition of land, earthwork, rails, sleepers, ballast, and other track items when constructing a wider gauge.
- (b) The cost of building bridges, culverts, and runnels increases only marginally due to a wider gauge.
- (c) The cost of constructing station buildings, platforms, staff quarters, level crossings, signals, etc., associated with the railway network is more or less the same for all gauges.

(d) The cost of rolling stock is independent of the gauge of the track for carrying the same volume of traffic.

Traffic considerations

The volume of traffic depends upon the size of wagons and the speed and hauling capacity of the train. Thus, the following points need to be considered.

- (a) As a wider gauge can carry larger wagons and coaches, it can theoretically carry more traffic.
- (b) A wider gauge has a greater potential at higher speeds, because speed is a function of the diameter of the wheel, which in turn is limited by the width of the gauge. As a thumb rule, diameter of the wheel is kept 75 per cent of gauge width.
- (c) The type of traction and signalling equipment required are independent of the gauge.

Physical features of the country

It is possible to adopt steeper gradients and sharper curves for a narrow gauge as compared to a wider gauge.

Uniformity of gauge

The existence of a uniform gauge in a country enables smooth, speedy, and efficient operation of trains. Therefore, a single gauge should be adopted irrespective of the minor advantages of a wider gauge and the few limitations of a narrower gauge.

Lecture-3

PROBLEMS OF MULTI GAUGE SYSTEM

Introduction

The need for uniformity of gauge has been recognized by all the advanced countries of the world. A number of problems have cropped up in the operation of the Indian Railways because of the multi-gauge system (use of three gauges). The ill effects of change of gauge (more popularly known as *break of gauge*) are numerous; some of these are enumerated here.

Inconvenience to passengers

Due to change of gauge, passengers have to change trains mid-journey along with their luggage, which causes inconvenience such as the following:

- (a) Climbing stairs and crossing bridges
- (b) Getting seats in the compartments of the later trains
- (c) Missing connections with the later trains in case the earlier train is late
- (d) Harassment caused by porters
- (e) Transporting luggage from one platform to another.

Difficulty in trans-shipment of goods

Goods have to be trans-shipped at the point where the change of gauge takes place. This causes the following problems:

- (a) Damage to goods during trans-shipment
- (b) Considerable delay in receipt of goods at the destination
- (c) Theft or misplacement of goods during trans-shipment and the subsequent claims
- (d) Non-availability of adequate and specialized trans-shipment labour and staff, particularly during strikes

Inefficient use of rolling stock

As wagons have to move empty in the direction of the trans-shipment point, they are not fully utilized. Similarly, idle wagons or engines of one gauge cannot be moved on another gauge.

Hindrance to fast movement of goods and passenger traffic

Due to change in the gauge, traffic cannot move fast which becomes a major problem particularly during emergencies such as war, floods, and accidents.

Additional facilities at stations and yards

Costly sheds and additional facilities need to be provided for handling the large volume of goods at trans-shipment points. Further, duplicate equipment and facilities such as yards and platforms need to be provided for both gauges at trans-shipment points.

Difficulties in balanced economic growth

The difference in gauge also leads to unbalanced economic growth. This happens because industries set up near MG/NG stations cannot send their goods economically and efficiently to areas being served by BG stations.

Difficulties in future gauge conversion projects

Gauge conversion is quite difficult, as it requires enormous effort to widen existing tracks. Widening the gauge involves heavy civil engineering work such as widening of the embankment, bridges and tunnels, as well as tracks; additionally, a wider rolling stock is also required. During the gauge conversion period, there are operational problems as well, since the traffic has to be slowed down and even suspended for a certain period in order to execute the work.

UNI-GAUGE POLICY OF INDIAN RAILWAYS

The problems caused by a multi-gauge system in a country have been discussed in the previous section. The multi-gauge system is not only costly and cumbersome but also causes serious bottlenecks in the operation of the Railways and hinders the balanced development of the country. Indian Railways therefore took the bold decision in 1992 of getting rid of the multi-gauge system and following the uni-gauge policy of adopting the broad gauge (1676 mm) uniformly.

Benefits of Adopting BG (1676 mm) as the Uniform Gauge

The uni-gauge system will be highly beneficial to rail users, the railway administration, as well as to the nation. Following are the advantages of a uni-system:

No transport bottlenecks

There will be no transport bottlenecks after a uniform gauge is adopted and this will lead to improved operational efficiency resulting in fast movement of goods and passengers.

No trans-shipment hazards

There will be no hazards of trans-shipment and as such no delays, no damage to goods, no inconvenience to passengers of transfer from one train to another train.

Provisions of alternate routes

Through a uni-gauge policy, alternate routes will be available for free movement of traffic and there will be less pressure on the existing BG network. This is expected to result in long-haul road traffic reverting to the railways.

Better turnaround

There will be a better turnaround of wagons and locomotives, and their usage will improve the operating ratio of the railway system as a whole. As a result the community will be benefited immensely.

Improved utilization of track

There will be improved utilization of tracks and reduction in the operating expenses of the railway.

Balanced economic growth

The areas currently served by the MG will receive an additional fillip, leading to the removal of regional disparities and balancing economic growth.

No multiple tracking works

The uni-gauge project will eliminate the need for certain traffic facilities and multiple tracking works, which will offset the cost of gauge conversions to a certain extent.

Better transport infrastructure

Some of the areas served by the MG have the potential of becoming highly industrialized; skilled manpower is also available. The uni-gauge policy will help in providing these areas a better transportation infrastructure.

Boosting investor's confidence

With the liberalization of the economic policy, the uni-gauge projects of Indian Railways have come to play a significant role. This will help in boosting the investors' confidence that their goods will be distributed throughout the country in time and without any hindrance. This will also help in setting up industries in areas not yet exploited because of the lack of infrastructure facilities.

Planning of Uni-gauge Projects

The gauge-conversion programme has been accelerated on Indian Railways since 1992. In the eighth Plan (1993-97) itself, the progress achieved in gauge-conversion projects in five years was more than the total progress made in the past 45 years. The progress of gauge-conversion projects is briefly given in Table below.

Progress of gauge-conversion projects

| <i>Year</i> | <i>Progress in gauge conversion (kms)</i> | <i>Remarks</i> |
|-------------|---|----------------|
| 1947-1992 | 2500 | Approx. figure |
| 1993-1997 | 6897 | Actual |
| 1998-2004 | 3787 | Actual |
| 2005-2011 | 6564 | Actual |

The current position is that the gauge-conversion project still pending on Indian Railways is 8855 kms which is likely to be completed in next five years. Execution of a gauge conversion project is quite a tricky job and lot of planning is to be done for the same.

Lecture-4

WHEEL AND AXIS ARRANGEMENTS AND CONING OF WHEELS

Introduction

Wheels and axles we have the different types of the locomotives under wagons which are used for the hauling of the passengers and freight. All these wagons and locomotives have different specifications depending on the gauges for which they have been used. If you look at the various locomotives from the very starting of our history, we have been using steam locomotives and then they have been replaced by diesel locomotives and finally by the electric locomotives.

In the case of the steam locomotives, the wheels and axles are classified by on the basis of **Whyte system**. Traditionally, steam locomotives have been classified using either their wheel arrangements or sometimes they are also been classified on the basis of axle arrangements.

In the case of the wheel arrangements classification, they are being classified on the basis of Whyte system and other system locomotives have three different types of wheel basis. They have the wheel basis which are either coupled or which are having the driving conditions or detective power attached to them or the wheel basis on which no attractive power is attached.

In Indian practice, the Indian practice has been taken from the United Kingdom because British were the persons who introduced the Indian railways in our country and in this system we count wheels and we do not count the axles as far as the steam locomotives are concerned. In the case of steam locomotives, one examples is been taken here where it is been shown as **2-4-2**. Now this 2-4-2 has the significance in terms of the wheel basis as been defined earlier. The first 2 is the front wheels or the 2 number of wheels have been placed or what we can say is that there is one axle which is being placed in the front condition. Then the 4 part is to the 4 number of wheels which have been placed in the central condition where they are the powered wheels or the driving wheels and therefore they transforms into the 2 axles condition and then there are trailing wheels where we have 2 wheels at the back and again, if it transform them into the actual condition, it will be working to one axle.

The compound locomotive is a condition where there is a more attractive power which is required to haul the passenger or the freight. The heavy amount of the freight which is to be transported and the trailing conditions governs the conditions where we require to provide two locomotives together so as to haul them. Here, this is an example of compound locomotive where two locomotive of

condition 2-8-2 or 2-8-4 have been joined together so as to haul the traffic or the passengers or the freight. Again, if we go by the Whyte condition, Whyte system of classification of the locomotives of the wheel configuration then 2-8-2 means they have 2 front wheels, 8 medium or central wheels and 2 trailer wheels, in case of the first locomotives whereas in the case of the second locomotives we have 2 front wheels, 8 central condition wheels which are electrically driven, which are driven for the movement of the locomotives and then in this case we have 4 trailing wheels.

Coning wheels has the following disadvantages:

1. In order to minimize the above below disadvantages the tilting of rails is done. i.e. the rails are not laid flat but tilted inwards by using inclined base plates sloped at 1 in 20 which is also the slope of coned surface of wheels.
2. The pressure of the horizontal component near the inner edge of the rail has a tendency to wear the rail quickly.
3. The horizontal components tend to turn the rail outwardly and hence the gauge is widened sometimes.
4. If no base plates are provided, sleepers under the outer edge of the rails are damaged.
5. In order to minimize the above mentioned disadvantages the tilting of rails is done. i.e. the rails are not laid flat but tilted inwards by using inclined base plates sloped at 1 in 20 which is also the slope of coned surface of wheels.

Advantages of Tilting of Rails

1. It maintains the gauge properly.
2. The wear at the head of rail is uniform.
3. It increases the life of sleepers and the rails.

Lecture-5

VARIOUS RESISTANCES AND THEIR EVALUATION

Introduction

Various forces offer resistance to the movement of a train on the track. These resistances may be the result of movement of the various parts of the locomotives as well as the friction between them, the irregularities in the track profile, or the atmospheric resistance to a train moving at great speed. The tractive power of a locomotive should be adequate enough to overcome these resistances and haul the train at a specified speed.

RESISTANCE DUE TO FRICTION

Resistance due to friction is the resistance offered by the friction between the internal parts of locomotives and wagons as well as between the metal surface of the rail and the wheel to a train moving at a constant speed. This resistance is independent of speed and can be further broken down into the following parts.

Journal friction This is dependent on the type of bearing, the lubricant used, the temperature and condition of the bearing, etc. In the case of roll bearings, it varies from 0.5 to 1.0 kg per tonne.

Internal resistance This resistance is consequential to the movement of the various parts of the locomotive and wagons.

Rolling resistance This occurs due to rail-wheel interaction on account of the movement of steel wheels on a steel rail. The total frictional resistance is given by the empirical formula

$$R_f = 0.0016 W$$

Where R_f is the frictional resistance independent of speed and W is the weight of the train in tonnes.

RESISTANCE DUE TO WAVE ACTION

When a train moves with speed a certain resistance develops due to the wave action in the rail. Similarly, track irregularities such as longitudinal unevenness and differences in cross levels also offer resistance to a moving train. Such resistances are different for different speeds. There is no

method for the precise calculation of these resistances but the following formula has been evolved based on experience:

$$R_2 = 0.00008 WV$$

Where R_2 is the resistance (in tonnes) due to wave action and track irregularities on account of the speed of the train, W is the weight of the train in tonnes, and V is the speed of the train in kmph.

RESISTANCE DUE TO WIND

When a vehicle moves with speed, a certain resistance develops, as the vehicle has to move forward against the wind. Wind resistance consists of side resistance, head resistance, and tail resistance, but its exact magnitude depends upon the size and shape of the vehicle, its speed, and the wind direction as well as its velocity. Wind resistance depends upon the exposed area of the vehicle and the velocity and direction of the wind. In Fig. below, V is the velocity of wind at an angle θ . The horizontal component of wind, $V \cos \theta$, opposes the movement of the train. Wind normally exerts maximum pressure when it acts at an angle of 60° to the direction of movement of the train.

Wind resistance can be obtained by the following formula:

$$R_3 = 0.000017AV^2$$

Where A is the exposed area of vehicle (m^2) and V is the velocity of wind (kmph).

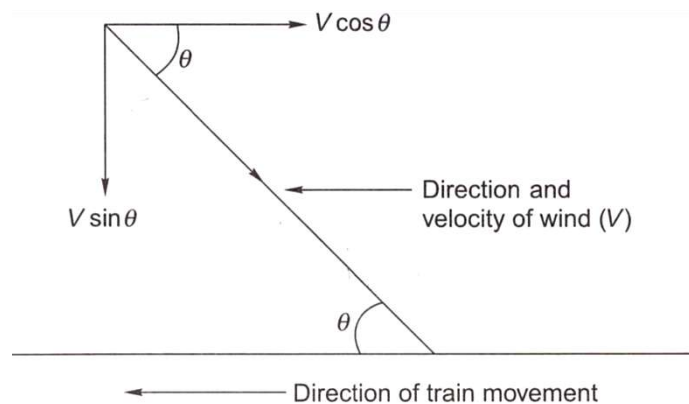

$$R_3 = 0.0000006 W V^2$$

Where R_3 is the wind resistance in tonnes, V is the velocity of the train in km per hour, and W is the weight of the train in tonnes.

RESISTANCE DUE TO GRADIENT

When a train moves on a rising gradient, it requires extra effort in order to move against gravity as shown in Fig. below.

Assuming that a wheel of weight W is moving on a rising gradient OA , the following forces act on the wheel.

- (a) Weight of the wheel (W), which acts downward
- (b) Normal pressure N on the rail, which acts perpendicular to OA
- (c) Resistance due to rising gradient (R_4), which acts parallel to OA

These three forces meet at a common point Q and the triangle QCD can be taken as a triangle of forces. It can also be geometrically proved that the two triangles QCD and AOB are similar.

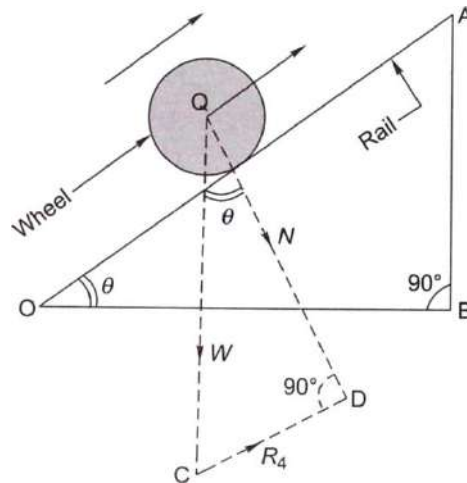

RESISTANCE DUE TO CURVATURE

When a train negotiates a horizontal curve, extra effort is required to overcome the resistance offered by the curvature of the track. Curve resistance is caused basically because of the following reasons (Fig. below):

- (a) The vehicle cannot adapt itself to a curved track because of its rigid wheel base. This is why the frame takes up a tangential position as the vehicle tries to move in a longitudinal direction along the curve as shown in Fig. below. On account of this, the flange of the outer wheel of the leading axle rubs against the inner face of the outer rail, giving rise to resistance to the movement of the train.

- (b) Curve resistance can sometimes be the result of longitudinal slip, which causes the forward motion of the wheels on a curved track. The outer wheel flange of the trailing axle remains clear and tends to derail. The position worsens further if the wheel base is long and the curve is sharp.
- (c) Curve resistance is caused when a transverse slip occurs, which increases the friction between the wheel flanges and the rails.
- (d) Poor track maintenance, particularly bad alignment, worn-out rails, and improper levels, also increase resistance.
- (e) Inadequate superelevation increases the pressure on the outer rail and, similarly, excess superelevation puts greater pressure on the inner rails, and this also contributes to an increase in resistance.

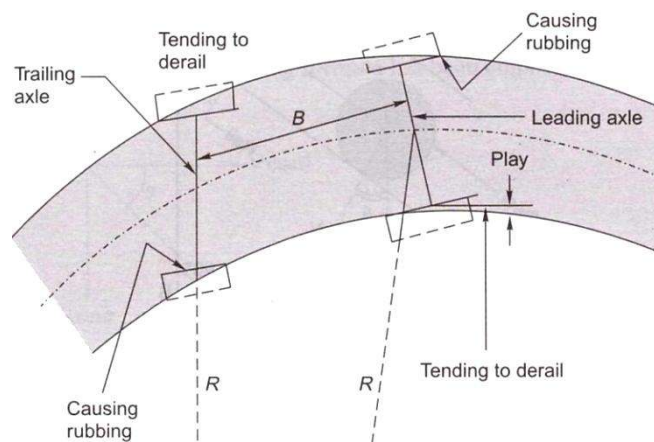

The value of curve resistance can be determined by the following equation:

$$\text{Curve resistance} = C \times (FG/R)$$

where F is the force of sliding friction, G is the gauge of the track, R is the mean radius of the curve, and C is the constant, which is dependent on various factors. This equation indicates that

- (a) curve resistance increases with increase in gauge width and
- (b) resistance is inversely proportional to the radius, i.e., it increases with an increase in the degree of the curve.

Empirical formulae have been worked out for curve resistance, which are as follows:

$$\text{Curve resistance for BG } (R_5) = 0.0004 \text{ WD}$$

$$\text{Curve resistance for MG } (R_5) = 0.0003 \text{ WD}$$

$$\text{Curve resistance for NG } (R_5) = 0.0002 \text{ WD}$$

Compensated gradient for curvature

Curve resistance is quite often compensated or offset by a reduction in the gradient. In this way, the effect of curve resistance is translated in terms of resistance due to gradient. The compensation is 0.04 per cent on BG, 0.03 per cent on MG, and 0.02 per cent on NG lines for every 1° of the curve. This will be clear through the solved example given below.

RESISTANCE DUE TO STARTING AND ACCELERATING

Trains face these resistances at stations when they start, accelerate, and decelerate. The values of these resistances are as follows:

$$\text{Resistance on starting, } R_6 = 0.15 W_1 + 0.005 W_2$$

$$\text{Resistance due to acceleration, } R_7 = 0.028 a W$$

where W_1 is the weight of the locomotive in tonnes, W_2 is the weight of the trailing vehicles in tonnes, W is the total weight of the locomotive and vehicle in tonnes. i.e. $W_1 + W_2$, and a is the acceleration, which can be calculated by finding the increase in velocity per unit time, i.e., $(V_2 - V_1)/t$, where V_2 is the final velocity, V_1 is the initial velocity, and t is the time taken.

Table below summarizes the various resistances faced by a train.

Lecture-6

HAULING CAPACITY AND TRACTIVE EFFORT

Introduction

The tractive effort of a locomotive is the force that the locomotive can generate for hauling the load. The tractive effort of a locomotive should be enough for it to haul a train at the maximum permissible speed. There are various tractive effort curves available for different locomotives for different speeds, which enable the computation of the value of tractive effort. Tractive effort is generally equal to or a little greater than the hauling capacity of the locomotive. If the tractive effort is much greater than what is required to haul the train, the wheels of the locomotive may slip.

A rough assessment of the tractive effort of different types of locomotive is provided in the following sections.

Steam Locomotive

The tractive effort of a steam locomotive can be calculated by equating the total power generated by the steam engine to the work done by the driving wheels.

Assume P to be the difference in steam pressure between the two sides of the cylinder, A the area of the piston of the engine, d the diameter of the piston of the engine, L the length of the stroke of the engine, D the diameter of the wheel of locomotive, and T_c the mean tractive effort of the locomotive. Work done by a double-cylinder steam engine

$$= 2 \times \text{difference in steam pressure} \times \text{area of the piston} \times 2 \times \text{length of the stroke} = 2P \times A \times 2L$$

$$= 2P \times (\pi d^2/4) \times 2L = \pi d^2 L P$$

work done in one revolution of the driving wheel of the locomotive:

$$= \text{tractive effort} \times \text{circumference of the wheel}$$

$$= T_c \pi D$$

Equating above two equations, $\pi d^2 L P = T_c \pi D$

$$T_c = d^2 L P / D$$

It is clear from above equation that tractive effort increases with an increase in steam pressure difference and the diameter and length of the piston, but decreases with an increase in the diameter of the driving wheel of the locomotive.

Diesel Locomotive

Tractive effort of a diesel-electric locomotive can be assessed by the following empirical formula.

$$T_e = (308 \times \text{RHP}) / V$$

where T_e is the tractive effort of a diesel-electric locomotive, RHP is the rated horsepower of the engine, and V is the velocity in km per hour.

Electric Locomotive

Tractive effort of an electric locomotive varies inversely with the power of speed. The empirical formulae for calculating the approximate value of tractive effort are as follows

For an dc electric locomotive: $T_e = a / V^3$

For an ac electric locomotive: $T_e = a / V^5$

where a is a constant depending upon the various characteristics of the locomotive.

.HAULING POWER OF A LOCOMOTIVE

Hauling power of a locomotive depends upon the weight exerted on the driving wheels and the friction between the driving wheel and the rail. The coefficient of friction depends upon the speed of the locomotive and the condition of the rail surface. The higher the speed of the locomotive, the lower will be the coefficient of friction, which is about 0.1 for high speeds and 0.2 for low speeds. The condition of the rail surface, whether wet or dry, smooth or rough, etc., also plays an important role in deciding the value of the coefficient of friction. If the surface is very smooth, the coefficient of friction will be very low.

$$\text{Hauling power} = \text{number of pairs of driving wheels} \times \text{weight exerted on each driving axle} \\ \times \text{coefficient of friction}$$

Thus, for a locomotive with three pairs of driving wheels, an axle load of 20 tonnes, and a coefficient of friction equal to 0.2, the hauling power will be equal to $3 \times 20 \times 0.2$ tonne, i.e., 12 tonnes.

Example : Calculate the maximum permissible load that a BG locomotive with three pairs of driving wheels bearing an axle load of 22 tonnes each can pull on a straight level track at a speed of 80 km/h. Also calculate the reduction in speed if the train has to run on a rising gradient of 1 in 200. What would be the further reduction in speed if the train has to negotiate a 4° curve on the rising gradient? Assume the coefficient of friction to be 0.2.

Lecture-7

RAIL

Introduction

Rails are the members of the track laid in two parallel lines to provide an unchanging, continuous, and level surface for the movement of trains. To be able to withstand stresses, they are made of high-carbon steel. Standard rail sections, their specifications, and various types of rail defects are discussed in this section.

FUNCTION OF RAILS

Rails are similar to steel girders. They perform the following functions in a track:

- (a) Rails provide a continuous and level surface for the movement of trains.
- (b) They provide a pathway which is smooth and has very little friction. The friction between the steel wheel and the steel rail is about one-fifth of the friction between the pneumatic tyre and a metalled road.
- (c) They serve as a lateral guide for the wheels.
- (d) They bear the stresses developed due to vertical loads transmitted to them through axles and wheels of rolling stock as well as due to braking and thermal forces.
- (e) They carry out the function of transmitting the load to a large area of the formation through sleepers and the ballast.

TYPES OF RAILS

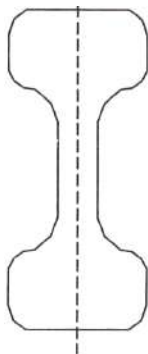

DOUBLE HEADED RAIL

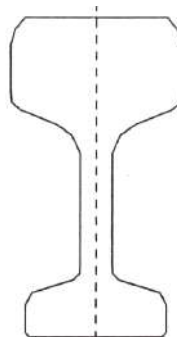

BULL HEADED RAIL

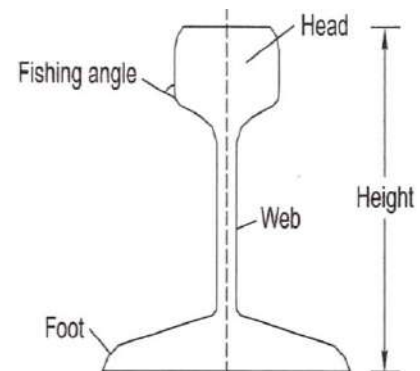

FLAT-FOOTED RAIL

REQUIREMENTS OF AN IDEAL RAIL SECTION

The requirements of an ideal rail section are as follows:

- (a) The rail should have the most economical section consistent with strength, stiffness, and durability.
- (b) The centre of gravity of the rail section should preferably be very close to the mid-height of the rail so that the maximum tensile and compressive stresses are equal.
- (c) A rail primarily consists of a head, a web, and a foot, and there should be an economical and balanced distribution of metal in its various components so that each of them can fulfill its requirements properly.

The requirements, as well as the main considerations, for the design of these rail components are as follows:

Head The head of the rail should have adequate depth to allow for vertical wear. The rail head should also be sufficiently wide so that not only is a wider running surface available, but also the rail has the desired lateral stiffness.

Web The web should be sufficiently thick so as to withstand the stresses arising due to the loads borne by it, after allowing for normal corrosion.

Foot The foot should be of sufficient thickness to be able to withstand vertical and horizontal forces after allowing for loss due to corrosion. The foot should be wide enough for stability against overturning. The design of the foot should be such that it can be economically and efficiently rolled.

Fishing angles These must ensure proper transmission of loads from the rails to the fish plates. The fishing angles should be such that the tightening of the plate does not produce any excessive stress on the web of the rail.

Height of the rail The height should be adequate so that the rail has sufficient vertical stiffness and strength as a beam.

Weight of rails

Though the weights of a rail and its section depend upon various considerations, the heaviest axle load that the rail has to carry plays the most important role. The following is the thumb rule for denning the maximum axle load with relation to the rail section:

Maximum axle load = 560 x sectional weight of rail in lbs per yard or kg per metre

- For rails of 90 lbs per yard,

Maximum axle load = $560 \times 90 \text{ lbs} = 50,400 \text{ lbs}$ or 22.5 tonnes

- For rails of 52 kg per m,

Maximum axle load = $560 \times 52 \text{ kg} = 29.12 \text{ tonnes}$

- For rail of 60 kg per m,

Max. axle load for 60 kg/m rail = $560 \times 60 \text{ kg} = 33.60 \text{ tonnes}$

Length of rails

Theoretically, the longer is the rail, the lesser would be the number of joints and fittings required and the lesser the cost of construction and maintenance. Longer rails are economical and provide smooth and comfortable rides. The length of a rail is, however, restricted due to the following factors:

- (a) Lack of facilities for transport of longer rails, particularly on curves
- (b) Difficulties in manufacturing very long rails
- (c) Difficulties in acquiring bigger expansion joints for long rails
- (d) Heavy internal thermal stresses in long rails

Taking the above factors into consideration, Indian Railways has standardized a rail length of 13 m (previously 42 ft) for broad gauge and 12 m (previously 39 ft) for MG and NG tracks. Indian Railways is also planning to use 39 m, and even longer rails in its track system. Now 65 m/78 m long rails are being produced at SAIL, Bhilai and it is planned to manufacture 130 m long rails.

Lecture-8

SLEEPERS

Introduction

Sleepers are the transverse ties that are laid to support the rails. They have an important role in the track as they transmit the wheel load from the rails to the ballast. Several types of sleepers are used on Indian Railways. The characteristics of these sleepers and their suitability with respect to load conditions are described in this section.

FUNCTIONS AND REQUIREMENTS OF SLEEPERS

The main functions of sleepers are as follows:

- (a) Holding the rails in their correct gauge and alignment
- (b) Giving a firm and even support to the rails
- (c) Transferring the load evenly from the rails to a wider area of the ballast
- (d) Acting as an elastic medium between the rails and the ballast to absorb the blows and vibrations caused by moving loads
- e) Providing longitudinal and lateral stability to the permanent way
- (f) Providing the means to rectify the track geometry during their service life

Apart from performing these functions the ideal sleeper should normally fulfill the following requirements.

- a) The initial as well as maintenance cost should be minimum.
- b) The weight of the sleeper should be moderate so that it is convenient to handle.
- c) The designs of the sleeper and the fastenings should be such that it is possible to fix and remove the rails easily.
- d) The sleeper should have sufficient bearing area so that the ballast under it is not crushed.
- e) The sleeper should be such that it is possible to maintain and adjust the gauge properly
- f) The material of the sleeper and its design should be such that it does not break or get damaged during packing.
- g) The design of the sleeper should be such that it is possible to have track circuiting.
- h) The sleeper should be capable of resisting vibrations and shocks caused by the passage of fast moving trains,

i) The sleeper should have anti-sabotage and anti-theft features.

SLEEPER DENSITY AND SPACING OF SLEEPERS

Sleeper density is the number of sleepers per rail length. It is specified as $(M + x)$ or $(N + x)$, where M or N is the length of the rail in metres and x is a number that varies according to factors such as

- (a) axle load and speed,
- (b) type and section of rails,
- (c) type and strength of the sleepers,
- (d) type of ballast and depth of ballast cushion, and
- (e) nature of formation.

If the sleeper density is $M + 7$ on a broad gauge route and the length of the rail is 13 m, it implies that $13 + 7 = 20$ sleepers will be used per rail length of the track on that route. The number of sleepers in a track can also be specified by indicating the number of sleepers per kilometre of the track, for example, 1540 sleepers/km. This specification becomes more relevant particularly in cases where rails are welded and the length of the rail does not have much bearing on the number of sleepers required. This system of specifying the number of sleepers per kilometre exists in many foreign countries and is now being adopted on Indian Railways as well.

The spacing of sleepers is fixed depending upon the sleeper density. Spacing is not kept uniform throughout the rail length. It is closer near the joints because of the weakness of the joints and impact of moving loads on them. There is, however, a limitation to the close spacing of the sleepers, as enough space is required for working the beaters that are used to pack the joint sleepers. The standard spacing specifications adopted for a fish-plated-track on Indian Railways are given in Table below. The notations used in this table are explained in Fig. below.

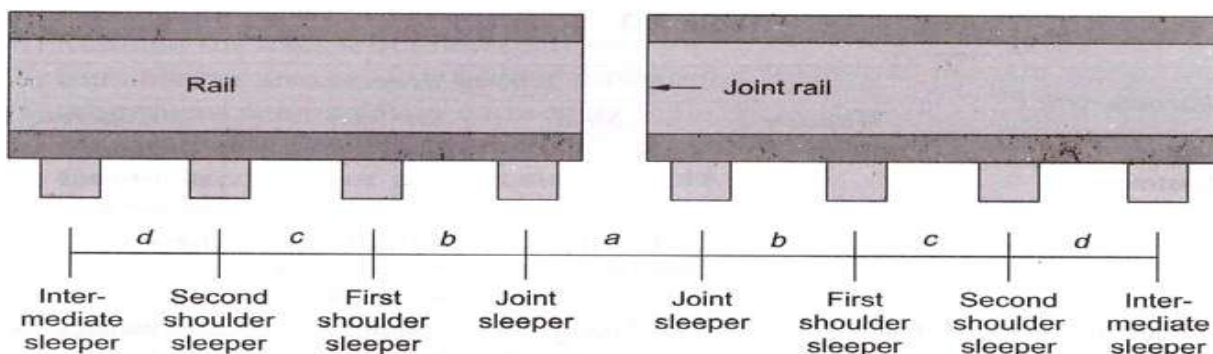

TYPES OF SLEEPERS

The sleepers mostly used on Indian Railways are

- (i) wooden sleepers,
- (ii) cast iron (CI) sleepers,
- (iii) steel sleepers, and
- (iv) Concrete sleepers.

Comparison of different types of sleepers

| Characteristics | Type of sleeper | | | |
|------------------------------------|--|--|--|--|
| | Wooden | Steel | 'CI | Concrete |
| Service life (years) | 12-15 | 40-50 | 40-50 | 50-60 |
| Weight of sleeper for BG (kg) | 83 | 79 | 87 | 267 |
| Handling | Manual handling; no damage to sleeper while handling | Manual handling; no damage to sleeper while handling | Manual handling; liable to break by rough handling | No manual handling; gets damaged by rough handling |
| Type of maintenance | Manual or mechanized | Manual or mechanized | Manual | Mechanized only |
| Cost of maintenance | High | Medium | Medium | Low |
| Gauge adjustment | Difficult | Easy | Easy | No gauge adjustment possible |
| Track circuiting | Best | Difficult; insulating pads are necessary | Difficult; insulating pads are necessary | Easy |
| Damage by white ants and corrosion | Can be damaged by white ants | No damage by white ants but corrosion is possible | Can be damaged by corrosion | No damage by white ants or corrosion |
| Suitability for fastening | Suitable for CF* and EF ^f | Suitable for CF and EF | Suitable for CF only | Suitable for EF only |
| Track elasticity | Good | Good | Good | Best |
| Creep | Excessive | Less | Less | Minimum |
| Scrap value | Low | Higher than wooden | High | None |

Lecture-9

BALLAST AND BALLAST REQUIREMENTS

Introduction

Ballast is a layer of broken stones, gravel, moorum, or any other granular material placed and packed below and around sleepers for distributing load from the sleepers to the formation. It provides drainage as well as longitudinal and lateral stability to the track. Different types of ballast materials and their specifications are discussed in this chapter.

FUNCTIONS OF BALLAST

The ballast serves the following functions in a railway track.

- It provides a level and hard bed for the sleepers to rest on.
- It holds the sleepers in position during the passage of trains.
- It transfers and distributes load from the sleepers to a large area of the formation.
- It provides elasticity and resilience to the track for proper riding comfort.
- It provides the necessary resistance to the track for longitudinal and lateral stability.
- It provides effective drainage to the track.
- It provides an effective means of maintaining the level and alignment of the track.

TYPES OF BALLAST

The different types of ballast used on Indian Railways are described here.

Sand ballast

Sand ballast is used primarily for cast iron (CI) pots. It is also used with wooden and steel trough sleepers in areas where traffic density is very low. Coarse sand is preferred in comparison to fine sand. It has good drainage properties, but has the drawback of blowing off because of being light. It also causes excessive wear of the rail top and the moving parts of the rolling stock.

Moorum ballast

The decomposition of laterite results in the formation of moorum. It is red, and sometimes yellow, in colour. The moorum ballast is normally used as the initial ballast in new constructions and also as sub-ballast. As it prevents water from percolating into the formation, it is also used as a blanketing material for black cotton soil.

Coal ash or cinder

This type of ballast is normally used in yards and sidings or as the initial ballast in new constructions since it is very cheap and easily available. It is harmful for steel sleepers and fittings because of its corrosive action.

Broken stone ballast

This type of ballast is used the most on Indian Railways. Good stone ballast is generally procured from hard stones such as granite, quartzite, and hard trap. The quality of stone should be such that neither it should be porous nor it flake off due to the weathering. Good quality hard stone is normally used for high-speed tracks. This type of ballast works out to be economical in the long run.

Other types of ballast

There are other types of ballast also such as the brickbat ballast, gravel ballast, kankar stone ballast, and even earth ballast. These types of ballast are used only in special circumstances.

The comparative advantages, disadvantages, and suitability of different types of ballast are given in Table below.

SIZES OF BALLAST

Previously, 50 mm (2") ballasts were specified for flat-bottom sleepers such as concrete and wooden sleepers, and 40 mm (1.5") ballasts for metal sleepers such as CST-9 and trough sleepers. Now, to ensure uniformity, 50 mm (2") ballasts have been adopted universally for all types of sleepers.

Points and crossings are subjected to heavy blows of moving loads and hence are maintained to a higher degree of precision. A small sized, 25 mm (1") ballast: s. therefore, preferable because of its fineness for slight adjustments, better compaction, and increased frictional area of the ballast.

For uniformity sake, the Indian Railways has adopted the same standard size of ballast for the main line as well as for points and crossings.

This standard size of ballast should be as per Indian Railways specification. The specification provides grading of ballast from 25 mm to 65 mm, maximum quantity of ballast being in the range of 40 mm to 50 mm size.

Table Comparison of different types of ballast

| Type of ballast | Advantages | Disadvantages | Suitability |
|------------------------|--|--|--|
| Sand ballast | Good drainage properties | Causes excessive wear | Suitable for CI pot sleeper tracks |
| | Cheap | Blows off easily | Not suitable for |
| | No noise produced on the track | Poor retentivity of packing | high-speed tracks |
| | Good packing material for CI sleepers | Track cannot be maintained to high standards | |
| Moorum ballast | Cheap, if locally available | Very soft and turns into dust | Used as a sub-ballast |
| | Prevents water from percolating | Maintenance of track is difficult | Initial ballast for new construction |
| | Provides good aesthetics | Quality of track average | |
| Coal ash or cinder | Easy availability on railways | Harmful for steel sleepers | Normally used in yards and sidings |
| | Very cheap | Corrodes rail bottom and steel sleepers | Suitable for repairs of formations during floods and emergencies |
| | Good drainage | Soft and easily pulverized | Not fit for high-speed tracks |
| Broken stone ballast | Hard and durable when procured from hard rocks | Maintenance is difficult | |
| | Initial cost is high | | Suitable for packing with track machines |
| | Good drainage properties | Difficulties in procurement | Suitable for high speed tracks |
| | Stable and resilient to the track | Angular shape may injure wooden sleepers | |
| . | Economical in the long run | | |

REQUIREMENTS OF GOOD BALLAST

Ballast material should possess the following properties,

- a) It should be tough and wear resistant.
- b) It should be hard so that it does not get crushed under the moving loads,
- c) It should be generally cubical with sharp edges.
- d) It should be non-porous and should not absorb water.
- e) It should resist both attrition and abrasion.
- f) It should be durable and should not get pulverized or disintegrated under adverse weather conditions
- (g) It should allow for good drainage of water,
- (h) It should be cheap and economical.

DESIGN OF BALLAST SECTION

The design of the ballast section includes the determination of the depth of the ballast cushion below the sleeper and its profile. These aspects are discussed as follows.

Minimum Depth of Ballast Cushion

The load on the sleeper is transferred through the medium of the ballast to the formation. The pressure distribution in the ballast section depends upon the size and shape of the ballast and the degree of consolidation. Though the lines of equal pressure are in the shape of a bulb as discussed in, yet for simplicity, the dispersion of load can be assumed to be roughly 45° to the vertical. In order to ensure that the load is transferred evenly on the formation, the depth of the ballast should be such that the dispersion lines do not overlap each other. For the even distribution of load on the formation, the depth of the ballast is determined by the following formula:

Sleeper spacing = width of the sleeper + 2 x depth of ballast

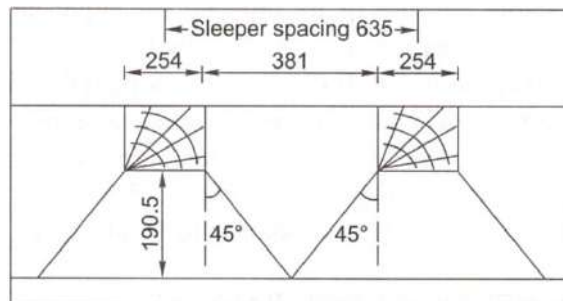

Minimum Depth of the Ballast Cushion

Lecture-10

FORMATION

Introduction

Subgrade is the naturally occurring soil which is prepared to receive the ballast. The prepared flat surface, which is ready to receive the ballast, along with sleepers and rails, is called the formation. The formation is an important constituent of the track, as it supports the entire track structure. It has the following functions:

- (a) It provides a smooth and uniform bed for laying the track.
- (b) It bears the load transmitted to it from the moving load through the ballast.
- (c) It facilitates drainage.
- (d) It provides stability to the track.

GENERAL DESCRIPTION OF FORMATION

The formation can be in the shape of an embankment or a cutting. When formation is in the shape of a raised bank constructed above the natural ground, it is called an *embankment*. The formation at a level below the natural ground is called a *cutting*. Normally, a cutting or an excavation is made through a hilly or natural ground for providing the railway line at the required level below the ground level.

The formation (Fig. below) is prepared either by providing additional earthwork over the existing ground to make an embankment or by excavating the existing ground surface to make a cutting. The formation can thus be in the shape of either an embankment or a cutting. The height of the formation depends upon the ground contours and the gradients adopted. The side slope of the embankment depends upon the shearing strength of the soil and its angle of repose. The width of the formation depends upon the number of tracks to be laid, the gauge, and such other factors. The recommended widths of formation as adopted on Indian Railway BG MG. and NG are given in Table below.

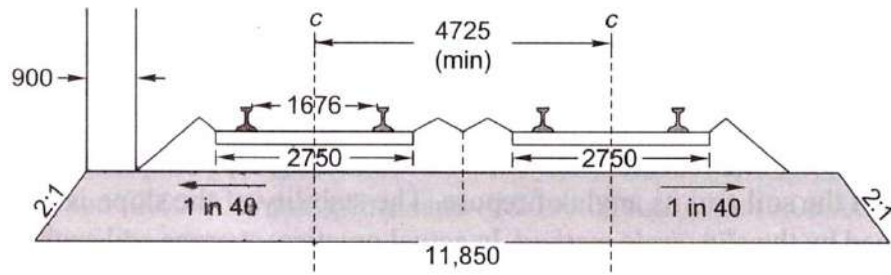

(a) Cross section of bank

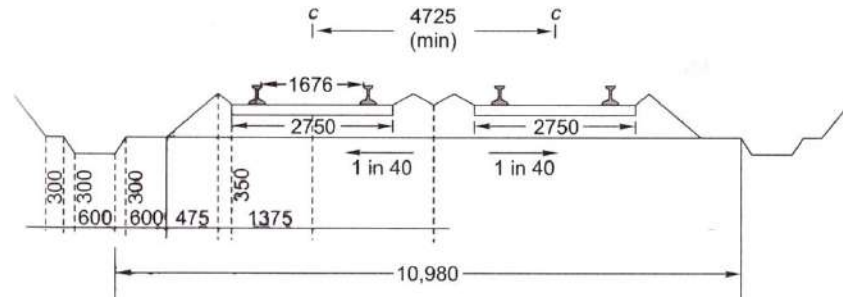

(b) Cross section of cutting

Typical cross section of bank and cutting for BG double line (dimensions in mm)

Table. Width of formation for different tracks

| Gauge | Type of sleepers | Single-line section | | Double-line section | |
|-------|-----------------------------------|---------------------|-------------------|---------------------|-------------------|
| | | Bank width (m) | Cutting width (m) | Bank width (m) | Cutting width (m) |
| BG | W,* ST, ¹ and concrete | 6.85 | 6.25 | 12.155 | 11.555 |
| MG | W, ST, CST-9, and concrete | 5.85 | 5.25 | 9.81 | 9.21 |
| NG | W, ST, and CST-9 | 3.70 | 3.35 | 7.32 | 7.01 |

W stands for wooden sleepers. ST stands for steel trough sleeper

Slopes of Formation

The side slopes of both the embankment and the cutting depend upon the shearing strength of the soil and its angle of repose. The stability of the slope is generally determined by the *slip circle method*. In actual practice, average soil such as sand or clay may require a slope of 2:1 (horizontal: vertical) for an embankment and 1:1 or 0.5:1 or even steeper particularly when rock is available for cutting.

To prevent erosion of the side slopes due to rain water, etc., the side slopes are turfed. A thin layer of cohesive soil is used for this purpose. Alternatively, the slopes are turfed with a suitable type of grass. Sometimes the bank also gets eroded due to standing water in the adjoining land. A toe and pitching are provided in such cases.

Permanent way is the generic term for the track (rails, sleepers and ballast) on which railway trains run. Although the configuration of the track today would be recognized by engineers of the 19th century, it has developed significantly over the years as technological improvements became available, and as the demands of train operation increased.

Requirement of Good Track

A permanent way or track should provide comfortable and safe ride at the maximum permissible speed with minimum maintenance cost. To achieve these objectives, a sound permanent way should have the following characteristics:

- The gauge should be correct and uniform.
- The rail should have perfect cross levels. In curves, the outer rail should have proper super elevation to take into account the centrifugal force.
- The alignment should be straight and free of kinks. In the case of curves, a proper transition should be provided between the straight track and the curve.
- The gradient should be uniform and as gentle as possible. The change of gradient should be followed by a proper vertical curve to provide a smooth ride.
- The track should be resilient and elastic in order to absorb the shocks and vibration of running trains.
- The track should have a good drainage system so that the stability of the track is not effected by water logging.
- The track should have good lateral strength so that it can maintain its stability despite variations in temperature and other such factors.
- There should be provisions for easy replacement and renewal of the various track components.
- The track should have such a structure that not only is its initial cost low, but also its maintenance cost is minimum.

REQUIREMENTS OF AN IDEAL PERMANENT WAY

The following are the principal requirements of an ideal permanent way or of a good railway track :-

- i. The gauge of the permanent way should be uniform, correct and it should not get altered.
- ii. Both the rails should be at the same level on tangent (straight) portion of the track.
- iii. Proper amount of *superelevation* should be provided to the outer rail above the inner rail on curved portion of the track.
- iv. The permanent way should be sufficiently strong against lateral forces.
- v. The curves, provided in the track, should be properly designed.
- vi. An even and uniform gradient should be provided through out the length of the track.
- vii. The *tractive resistance* of the track should be minimum.
- viii. The design of the permanent way should be such that the load of the train is uniformly distributed on both the rails so as to prevent unequal settlement of the track.
- ix. It Should provide adequate elasticity in order to prevent the harshness of impacts between the rails and the moving wheel loads of a train.
- x. It should be free from excessive rail joints and all the joining should be properly designed and constructed.
- xi. All the components parts such as *rails, sleepers, ballast, fixtures* and *fastenings*, etc. should satisfy the design requirements.
- xii. All the fixtures and fastenings such as *chairs, bearing plates, fish plates, fish bolts, spikes* etc. should be strong enough to withstand the stresses occurring in the track.
- xiii. All the **points and crossings*, laid in the permanent way, should be properly designed and carefully constructed.
- xiv. It should be provided with fence near *level crossings* and also in urban areas.
- xv. It should be provided with proper drainage facilities so as to drain off the rain water quickly away from the track.
- xvi. It should be provided with safe and strong bridges coming in the alignment of the track.
- xvii. It should be provided with safe and strong bridges coming in the alignment of the track.
- xviii. It should be so constructed that repairs and renewals of any of its portion can be carried out without any difficulty.

Lecture-11

WEAR AND FAILURE IN RAILS

RAIL WEAR

Due to the passage of moving loads and friction between the rail and the wheel, the rail head gets worn out in the course of service. The impact of moving loads, the effect of the forces of acceleration, deceleration, and braking of wheels, the abrasion due to rail-wheel interaction, the effects of weather conditions such as changes in temperature, snow, and rains, the presence of materials such as sand, the standard of maintenance of the track, and such allied factors cause considerable wear and tear of the vertical and lateral planes of the rail head. Lateral wear occurs more on curves because of the lateral thrust exerted on the outer rail by centrifugal force. A lot of the metal of the rail head gets worn out, causing the weight of the rail to decrease. This loss of weight of the rail section should not be such that the stresses exceed their permissible values. When such a stage is reached, rail renewal is called for.

In addition, the rail head should not wear to such an extent that there is the possibility of a worn flange of the wheel hitting the fish plate.

Types of Wear on Rails

A rail may face wear and tear in the following positions:

- (a) On top of the rail head (*vertical wear*)
- (b) On the sides of the rail head (*lateral wear*)
- (c) On the ends of the rail (*battering of rail ends*)

Wear is more prominent at some special locations of the track. These locations are normally the following:

- (a) On sharp curves, due to centrifugal forces
- (b) On steep gradients, due to the extra force applied by the engine
- (c) On approaches to railway stations, possibly due to acceleration and deceleration
- (d) In tunnels and coastal areas, due to humidity and weather effects

Measurement of Wear

Wear on rails can be measured using any of the following methods:

- (a) By weighing the rail
- (b) By profiling the rail section with the help of lead strips

- (c) By profiling the rail section with the help of needles
- (d) By using special instruments designed to measure the profile of the rail and record it simultaneously on graph paper

Methods to Reduce Wear

Based on field experience, some of the methods adopted to reduce vertical wear and lateral wear on straight paths and curves are as follows-

- (a) Better maintenance of the track to ensure good packing as well as proper alignment and use of the correct gauge
- (b) Reduction in the number of joints by welding
- (c) Use of heavier and higher UTS rails, which are more wear resistant
- (d) Use of bearing plates and proper adzing in case of wooden sleepers
- (e) Lubricating the gauge face of the outer rail in case of curves
- (f) Providing check rails in the case of sharp curves
- (g) Interchanging the inner and outer rails
- (h) Changing the rail by carrying out track renewal

Rail End Batter

The hammering action of moving loads on rail joints batters the rail ends in due course of time. Due to the impact of the blows, the contact surfaces between the rails and sleepers also get worn out, the ballast at places where the sleepers are joined gets shaken up, the fish bolts become loose, and all these factors further worsen the situation, thereby increasing rail end batter.

Rail end batter is measured as the difference between the height of the rail at the end and at a point 30 cm away from the end. If the batter is up to 2 mm, it is classified 'average', and if it is between 2 and 3 mm, it is classified as 'severe'. When rail end batter is excessive and the rail is otherwise alright, the ends can be cropped and the rail reused.

OTHER DEFECTS IN RAILS

Rail wear and battering of rail ends are the two major defects in rails. However some other types of defects may also develop in a rail and necessitate its removal in extreme cases. These are as follows:

Hogging of rails

Rail ends get hogged due to poor maintenance of the rail joint, yielding format, loose and faulty fastenings, and other such reasons. Hogging of rails causes the quality of the track to deteriorate. This defect can be remedied by measured she packing.

Scabbing of rails

The scabbing of rails occurs due to the falling of patches or chunks of metal from the rail table. Scabbing is generally seen in the shape of an elliptical depression; whose surface reveals a progressive fracture with numerous cracks around it.

Wheel burns

Wheel burns are caused by the slipping of the driving wheel of locomotives on the rail surface. As a consequence, extra heat is generated and the surface of the rail gets affected, resulting in a depression on the rail table. Wheel burns are generally noticed on steep gradients or where there are heavy incidences of braking or near water columns.

Shelling and black spots

Shelling is the progressive horizontal separation of metal that occurs on the gauge side, generally at the upper gauge corner. It is primarily caused by heavy bearing pressure on a small area of contact, which produces heavy internal shear stress.

Corrugation of rail:

Corrugation consists of minute depressions on the surface of rails, varying in shape and size and occurring at irregular intervals. The exact cause of corrugation is not yet known, though many theories have been put forward. The factors which help in the formation of rail corrugation, however, are briefly enumerated here,

a) Metallurgy and age of rails

(i) High nitrogen content of the rails

(ii) Effect of oscillation at the time of rolling and straightening of rails

(b) Physical and environment conditions of track

- (i) Steep gradients (ii) Yielding formation (iii) Long tunnels (iv) Electrified sections
- (c) Train operations
 - (i) High speeds and high axle loads (ii) Starting locations of trains (iii) Locations where brakes are applied to stop the train
- (d) Atmospheric effects
 - (i) High moisture content in the air particularly in coastal areas (ii) Presence of sand

RAIL FAILURE

A rail is said to have failed if it is considered necessary to remove it immediately from the track on account of the defects noticed on it. The majority of rail failures originate from the fatigue cracks caused due to alternating stresses created in the rail section on account of the passage of loads. A rail section is normally designed to take a certain minimum GMT of traffic, but sometimes due to reasons such as an inherent defect in the metal, the section becomes weak at a particular point and leads to premature failure of the rail.

- (b) Physical and environment conditions of track
 - (i) Steep gradients (ii) Yielding formation (iii) Long tunnels (iv) Electrified sections
- (c) Train operations
 - (i) High speeds and high axle loads (ii) Starting locations of trains (iii) Locations where brakes are applied to stop the train
- (d) Atmospheric effects
 - (i) High moisture content in the air particularly in coastal areas (ii) Presence of sand

The corrugation of rails is quite an undesirable feature. When vehicles pass over corrugated rails, a roaring sound is produced, possibly due to the locking of air in the corrugation. This phenomenon is sometimes called 'Roaring of rails'. This unpleasant and excessive noise causes great inconvenience to the passengers. Corrugation also results in the rapid oscillation of rails, which in turn loosens the keys, causes excessive wear to fittings, and disturbs the packing.

Causes of Rail Failures

The main causes of failure of rails are as follows:

Inherent defects in the rail These are due to manufacturing defects in the rail, such as faulty chemical composition, harmful segregation, piping, seams, laps, and guide marks.

Defects due to fault of the rolling stock and abnormal traffic effects Flat soots in tvres, engine burns, skidding of wheels, severe braking, etc.

Excessive corrosion of rails This generally takes place due to weather conditions, the presence of corrosive salts such as chlorides and constant exposure of the rails to moisture and humidity in locations near water columns, ashpits, tunnels, etc. Corrosion normally leads to the development of cracks in regions with a high concentration of stresses.

Badly maintained joints Poor maintenance of joints such as improper packing of joint sleepers and loose fittings.

Defects in welding of joints These defects arise either because of improper composition of the thermit weld metal or because of a defective welding technique.

Improper maintenance of track Ineffective or careless maintenance of the track or delayed renewal of the track.

Derailments The rails are damaged during derailment.

Classification of Rail Failures

The classification of rail failures on Indian Railways has been codified for easy processing of statistical data. The code is made up of two portions—the first portion consisting of three code letters and the second portion consisting of three or four code digits.

First portion of the code The three code letters make up the first portion and denote the following.

(i) Type of rail being used (O for plain rail and X for points and crossing rails) (ii) Reasons for withdrawal of rail (F for fractured, C for cracked, and D for defective)

(iii) Probable cause failure (S for fault of rolling stock, C for excessive corrosion, D for derailment, and O for others)

Second portion of code The second portion consisting of three or four digits gives the following information, (i) First digit indicate the location of the fracture on the length of the rail (1 for

within fish plate limits and 2 for other portions on the rail), (ii) Second digit indicate the position in the rail section from where the failure started (0 for unknown, 1 for within rail head, 2 for surface of rail head, 3 for web, and 4 for foot).

(iii) Third digit indicate the direction of crack or fracture (0 to 9). (iv) Any other information about the fracture, where it is necessary to provide further subdivision. No specific system is recommended for this code.

Metallurgical Investigation

The following types of defective rails should normally be sent for metallurgical investigation, (i)

Rails that have been removed from the track as a result of visual or ultrasonic detection

(ii) Rail failures falling in categories in which cracks or surface defects develop at specified locations

Lecture-12

CREEP OF RAIL

Introduction

Creep is defined as the longitudinal movement of the rail with respect to the sleepers. Rails have a tendency to gradually move in the direction of dominant traffic. Creep is common to all railway tracks, but its magnitude varies considerably from place to place; the rail may move by several centimeters in a month at few places, while at other locations the movement may be almost negligible.

THEORIES FOR THE DEVELOPMENT OF CREEP

Various theories have been put forward to explain the phenomenon of creep and its causes, but none of them have proved to be satisfactory. The important theories are briefly discussed in the following subsections.

Wave Motion Theory

According to wave motion theory, wave motion is set up in the resilient track because of moving loads, causing a deflection in the rail under the load. The portion of the rail immediately under the wheel gets slightly depressed due to the wheel load. Therefore, the rails generally have a wavy formation.

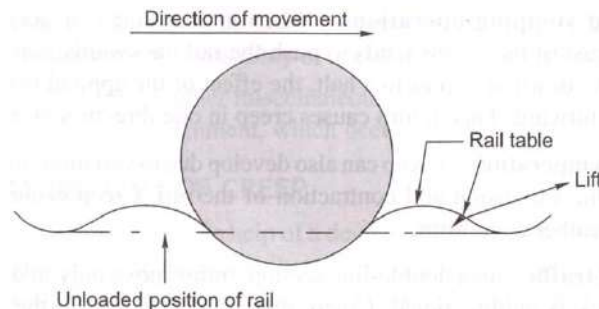

Percussion Theory

According to percussion theory, creep is developed due to the impact of wheels at the rail end ahead of a joint. As the wheels of the moving train leave the trailing rail at the joint, the rail gets pushed forward causing it to move longitudinally in the direction of traffic, and that is how creep develops. Though the impact of a single wheel may be nominal, the continuous movement of several wheels passing over the joint pushes the facing or landing rail forward, thereby causing creep.

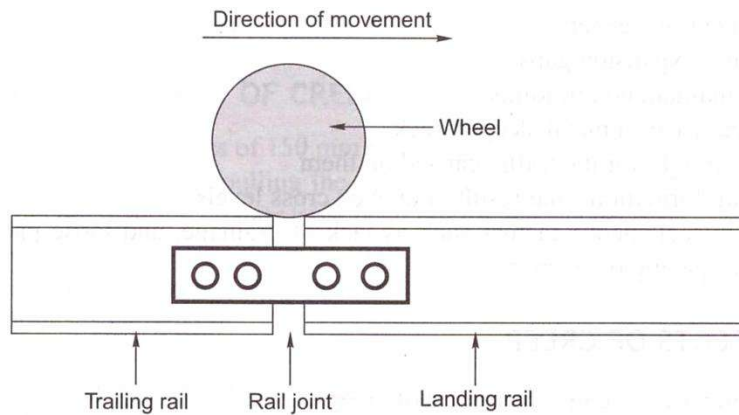

Drag Theory

According to drag theory, the backward thrust of the driving wheels of a locomotive has the tendency to push the rail backwards, while the thrust of the other wheels of the locomotive and trailing wagons pushes the rail in the direction in which the locomotive is moving. This results in the longitudinal movement of the rail in the direction of traffic, thereby causing creep.

CAUSES OF CREEP

The main factors responsible for the development of creep are as follows.

Ironing effect of the wheel The ironing effect of moving wheels on the waves formed in the rail tends to cause the rail to move in the direction of traffic, resulting in creep.

Starting and stopping operations When a train starts or accelerates, the backward thrust of its wheels tends to push the rail backwards. Similarly, when the train slows down or comes to a halt, the effect of the applied brakes tends to push the rail forward. This in turn causes creep in one direction or the other.

Changes in temperature Creep can also develop due to variations in temperature resulting in the expansion and contraction of the rail. Creep occurs frequently during hot weather conditions.

Unbalanced traffic In a double-line section, trains move only in one direction, i.e., each track is unidirectional. Creep, therefore, develops in the direction of traffic. In a single-line section, even though traffic moves in both directions, the volume of traffic in each direction is normally variable. Creep, therefore, develops in the direction of predominant traffic.

Poor maintenance of track Some minor factors, mostly relating to poor maintenance of the track, also contribute to the development of creep. These are as follows:

- Improper securing of rails to sleepers

- Limited quantities of ballast resulting in inadequate ballast resistance to the movement of sleepers
- Improper expansion gaps
- Badly maintained rail joints
- Rail seat wear in metal sleeper track
- Rails too light for the traffic carried on them
- Yielding formations that result in uneven cross levels
- Other miscellaneous factors such as lack of drainage, and loose packing, uneven spacing of sleepers

EFFECTS OF CREEP

The following are the common effects of creep.

Sleepers out of square The sleepers move out of their position as a result of creep and become out of square. This in turn affects the gauge and alignment of the track, which finally results in unpleasant rides.

Expansion in gaps get disturbed Due to creep, the expansion gaps widen at some places and close at others. This results in the joints getting jammed. Undue stresses are created in the fish plates and bolts, which affect the smooth working of the switch expansion joints in the case of long welded rails.

Distortion of points and crossings Due to excessive creep, it becomes difficult to maintain the correct gauge and alignment of the rails at points and crossings.

Difficulty in changing rails If, due to operational reasons, it is required that the rail be changed, the same becomes difficult as the new rail is found to be either too short or too long because of creep.

Effect on interlocking The interlocking mechanism of the points and crossings gets disturbed by creep.

Possible buckling of track If the creep is excessive and there is negligence in the maintenance of the track, the possibility of buckling of the track cannot be ruled out.

Other effects There are other miscellaneous effects of creep such as breaking of bolts and kinks in the alignment, which occur in various situations.

MEASUREMENT OF CREEP

Creep can be measured with the help of a device called creep indicator. It consists of two creep posts, which are generally rail pieces that are driven at 1 km intervals on either side of the track. For the purpose of easy measurement, their top level is generally at the same level as the rail. Using a chisel, a mark is made at the side of the bottom flange of the rail on either side of the track. A fishing string is then stretched between the two creep posts and the distance between the chisel mark and the string is taken as the amount of creep.

According to the prescribed stipulations, creep should be measured at intervals of about three months and noted in a prescribed register, which is to be maintained by the permanent way inspector (PWI). Creep in excess of 150 mm (6 in.) should not be permitted on any track and not more than six consecutive rails should be found jammed in a single-rail track at one location. There should be no creep in approaches to points and crossings.

ADJUSTMENT OF CREEP

When creep is in excess of 150 mm resulting in maintenance problems, the same should be adjusted by pulling the rails back. This work is carried out after the required engineering signals have been put up and the necessary caution orders given. The various steps involved in the adjustment of creep are as follows:

- (i) A careful survey of the expansion gaps and of the current position of rail joints is carried out.
- (ii) The total creep that has been proposed to be adjusted and the correct expansion gap that is to be kept are decided in advance.
- (iii) The fish plates at one end are loosened and those at the other end are removed. Sleeper fittings, i.e., spikes or keys, are also loosened or removed.
- (iv) The rails are then pulled back one by one with the help of a rope attached to a hook. The pulling back should be regulated in such a way that the rail joints remain central and suspended on the joint sleepers.

The pulling back of rails is a slow process since only one rail is dealt with at a time and can be done only for short isolated lengths of a track. Normally, about 40-50 men are required per kilometre for adjusting creep. When creep is required to be adjusted for longer lengths, five rail lengths are tackled at a time. The procedure is almost the same as the preceding steps

except that instead of pulling the rails with a rope, a blow is given to them using a cut rail piece of a length of about 5 m.

CREEP ADJUSTER

A creep adjuster is normally used when extensive work is involved. The creep adjuster is set at the centre of the length of the track, to be tackled, with the wide joints behind it and the jammed joints ahead of it. The following steps are adopted while using a creep adjuster:

- (i) Expansion liners of the correct size are put in all the expansion gaps,
- (ii) All the keys on the side (with wide joints) of the creep adjuster are removed and all fish bolts loosened,
- (iii) The creep adjuster is then used to close up the gaps to the required extent by pushing the rails forward. A gap of a few inches is left between the rail ends opposite the adjuster,
- (iv) The corrected rails are then fastened with keys. After that, the rails on the other side of the adjuster are tackled,
- (v) The operation leaves some of the expansion gaps too wide which are tackled by the creep adjuster when it is set in the next position,
- (vi) The corrected rails are then fastened and the adjuster is shifted to the new position,
- (vii) The whole process is repeated again and again till the requisite attention has been paid to the entire length of the rail. In the end it may be necessary to use a rail with the correct size of closure (bigger or smaller) to complete the work.

Lecture-13

RAIL JOINTS

Introduction

Although a rail joint has always been an integral part of the railway track, it is looked upon as a necessary evil because of the various problems that it presents. Earlier, rails were rolled in short lengths due to difficulties in rolling and the problem of transportation. With increase in temperature, rails expand and this expansion needs to be considered at the joints. It was, therefore, felt that the longer the rail, the larger the required expansion gap, and this too limited the length of the rail. A rail joint is thus an inevitable feature of railway tracks, even though it presents a lot of problems in the maintenance of the permanent way. This chapter discusses the various types of rail joints and their suitability on a railway track.

ILL EFFECTS OF A RAIL JOINT

A rail joint is the weakest link in the track. At a joint, there is a break in the continuity of the rail in both the horizontal and the vertical planes because of the presence of the expansion gap and imperfection in the levels of rail heads. A severe jolt is also experienced at the rail joint when the wheels of vehicles negotiate the expansion gap. This jolt loosens the ballast under the sleeper bed, making the maintenance of the joint difficult. The fittings at the joint also become loose, causing heavy wear and tear of the track material. Some of the problems associated with the rail joint are as follows.

Maintenance effort

Due to the impact of moving loads on the joint, the packing under the sleeper loosens and the geometry of the track gets distorted very quickly because of which the joint requires frequent attention. It is generally seen that about 30 per cent extra labour is required for maintenance of a joint.



Bonded main line 6-bolt rail joint on a segment of 76.9 kg/m rail. Note how bolts are oppositely oriented to prevent complete separation of the joint in the event of being struck by a wheel during a derailment.

Lifespan

The life of rails, sleepers, and fastenings gets adversely affected due to the extra stresses created by the impact of moving loads on the rail joint. The rail ends particularly get battered and hogged and chances of rail fracture at joints are considerably high due to fatigue stresses in the rail ends.

Noise effect

A lot of noise pollution is created due to rail joints, making rail travel uncomfortable.

Sabotage chances

Wherever there is a rail joint, there is a potential danger of the removal of fish plates and rails by miscreants and greater susceptibility to sabotage.

Impact on quality

The quality of the track suffers because of excessive wear and tear of track components and rolling stock caused by rail joints.

Fuel consumption

The presence of rail joints results in increased fuel consumption because of the extra effort required by the locomotive to haul the train over these joints.

REQUIREMENTS OF AN IDEAL RAIL JOINT

An ideal rail joint provides the same strength and stiffness as the parent rail. The characteristics of an ideal rail joint are briefly summarized here.

Holding the rail ends:An ideal rail joint should hold both the rail ends in their precise location in the horizontal as well as the vertical planes to provide as much continuity in the track as possible. This helps in avoiding wheel jumping or the deviation of the wheel from its normal path of movement.

Strength: An ideal rail joint should have the same strength and stiffness as the parent rails it joins.

Expansion gap:The joint should provide an adequate expansion gap for the free expansion and contraction of rails caused by changes in temperature

Flexibility It should provide flexibility for the easy replacement of rails, whenever required.

Provision for wear:It should provide for the wear of the rail ends, which is likely to occur under normal operating conditions.

Elasticity:It should provide adequate elasticity as well as resistance to longitudinal forces so as to ensure a trouble-free track.

Cost:The initial as well as maintenance costs of an ideal rail joint should be minimal.

TYPES OF RAIL JOINTS

The nomenclature of rail joints depends upon the position of the sleepers or the joints.

Classification According to Position of Sleepers

Three types of rail joints come under this category.

Supported joint

In this type of joint, the ends of the rails are supported directly on the sleeper. It was expected that supporting the joint would reduce the wear and tear of the rails, as there would be no cantilever action. In practice, however, the support tends to slightly raise the height of the rail ends. As such, the run on a supported joint is normally hard. There is also wear and tear of the sleeper supporting the joint and its maintenance presents quite a problem. The duplex sleeper is an example of a supported joint (Fig. below).

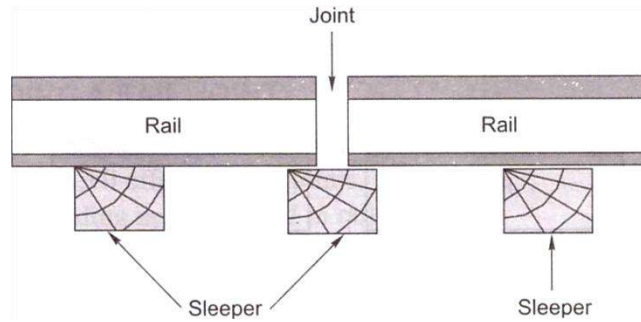

Fig. Supported rail joint

Suspended joint

In this type of joint, the ends of the rails are suspended between two sleepers and some portion of the rail is cantilevered at the joint. As a result of cantilever action, the packing under the sleepers of the joint becomes loose particularly due to the hammering action of the moving train loads. Suspended joints are the most common type of joints adopted by railway systems worldwide, including India (Fig. 16.2).

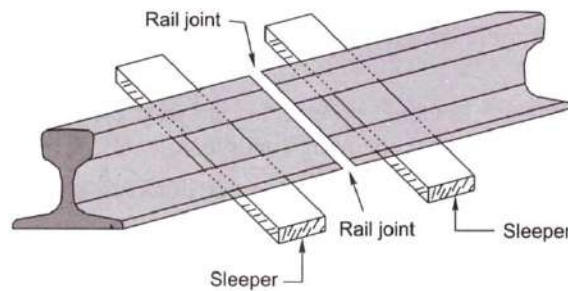

Fig. Suspended joint

Bridge joints

The bridge joint is similar to the suspended joint except that the two sleepers on either side of a bridge joint are connected by means of a metal flat [Fig. (a)] or a corrugated plate known as a bridge plate [Fig. 16.3(b)]. This type of joint is generally not used on Indian Railways.

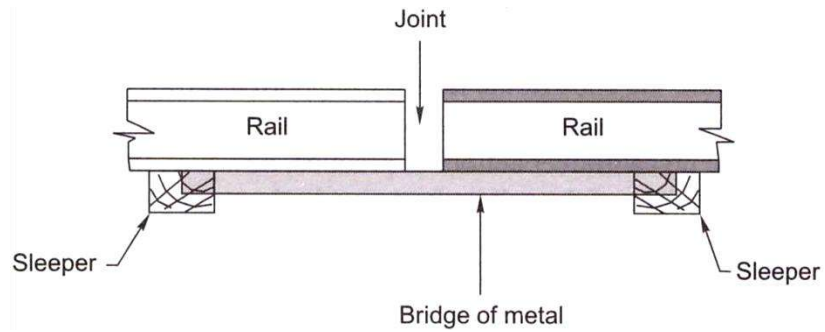

Fig. (a) Bridge joint with metal flat Joint

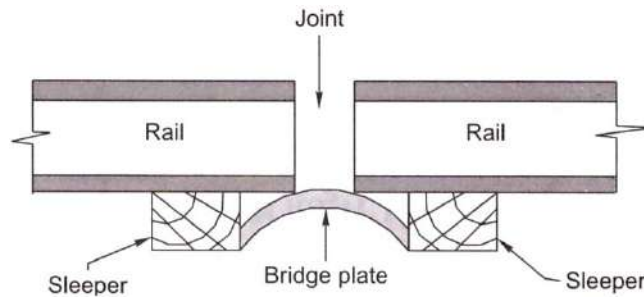
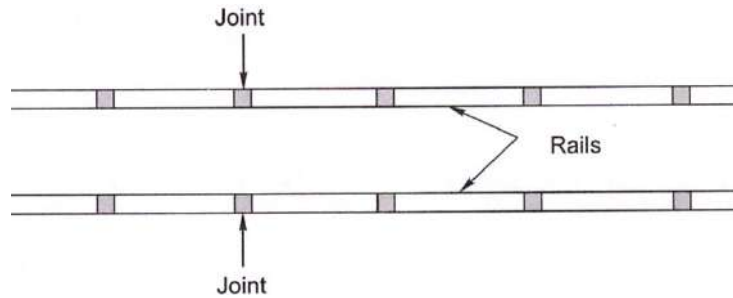

Fig. (b) Bridge joint with bridge plate

Classification Based on the Position of the Joint

Two types of rail joints fall in this category.

Square joint In this case, the joints in one rail are exactly opposite to the joints in the other rail. This type of joint is most common on Indian Railways (Fig. below).



Staggered joint In this case, the joints in one rail are somewhat staggered and are not opposite the joints in the other rail. Staggered joints are normally preferred on curved tracks because they hinder the centrifugal force that pushes the track outward (Fig. below).

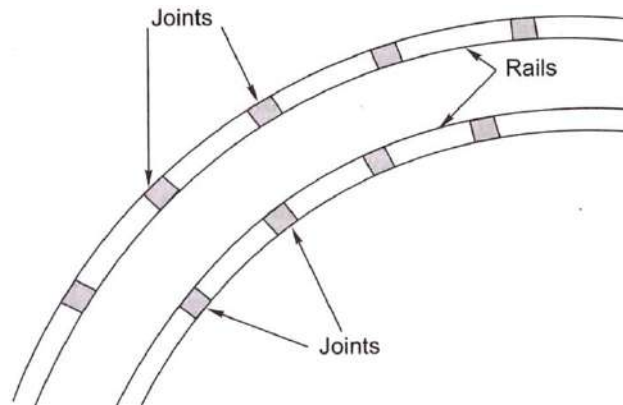

WELDING A RAIL JOINT

The purpose of welding is to join rail ends together by the application of heat and thus eliminate the evil effects of rail joints.

There are four welding methods used in railways.

- a) Gas pressure welding
- b) Electric arc or metal arc welding
- c) Flash butt welding
- d) Thermit welding

Lecture-14

BEARING PLATES, ANTI-CREEP DEVICES

ADJUSTMENT OF CREEP

When creep is in excess of 150 mm resulting in maintenance problems, the same should be adjusted by pulling the rails back. This work is carried out after the required engineering signals have been put up and the necessary caution orders given. The various steps involved in the adjustment of creep are as follows:

- (v) A careful survey of the expansion gaps and of the current position of rail joints is carried out.
- (vi) The total creep that has been proposed to be adjusted and the correct expansion gap that is to be kept are decided in advance.
- (vii) The fish plates at one end are loosened and those at the other end are removed. Sleeper fittings, i.e., spikes or keys, are also loosened or removed.
- (viii) The rails are then pulled back one by one with the help of a rope attached to a hook. The pulling back should be regulated in such a way that the rail joints remain central and suspended on the joint sleepers.

The pulling back of rails is a slow process since only one rail is dealt with at a time and can be done only for short isolated lengths of a track. Normally, about 40-50 men are required per kilometre for adjusting creep. When creep is required to be adjusted for longer lengths, five rail lengths are tackled at a time. The procedure is almost the same as the preceding steps except that instead of pulling the rails with a rope, a blow is given to them using a cut rail piece of a length of about 5 m.

CREEP ADJUSTER

A creep adjuster is normally used when extensive work is involved. The creep adjuster is set at the centre of the length of the track, to be tackled, with the wide joints behind it and the jammed joints ahead of it. The following steps are adopted while using a creep adjuster:

- (viii) Expansion liners of the correct size are put in all the expansion gaps,
- (ix) All the keys on the side (with wide joints) of the creep adjuster are removed and all fish bolts loosened,

- (x) The creep adjuster is then used to close up the gaps to the required extent by pushing the rails forward. A gap of a few inches is left between the rail ends opposite the adjuster,
- (xi) The corrected rails are then fastened with keys. After that, the rails on the other side of the adjuster are tackled,
- (xii) The operation leaves some of the expansion gaps too wide which are tackled by the creep adjuster when it is set in the next position,
- (xiii) The corrected rails are then fastened and the adjuster is shifted to the new position,
- (xiv) The whole process is repeated again and again till the requisite attention has been paid to the entire length of the rail. In the end it may be necessary to use a rail with the correct size of closure (bigger or smaller) to complete the work.

PORTIONS OF TRACK SUSCEPTIBLE TO CREEP

The following locations of a track are normally more susceptible to creep.

- The point where a steel sleeper track or CST-9 sleeper track meets a wooden sleeper track
- Dips in stretches with long gradients
- Approaches to major girder bridges or other stable structures
- Approaches to level crossings and points and crossings
- Steep gradients and sharp curves

MEASURES TO REDUCE CREEP

To reduce creep in a track, it should be ensured that the rails are held firmly to the sleepers and that adequate ballast resistance is available. All spikes, screws, and keys should be driven home. The toe load of fastenings should always be slightly more than the ballast resistance. Creep anchors can effectively reduce the creep in a track. At least eight of these creep anchors must be provided per panel. Out of the large number of creep anchors tried on Indian Railways, the 'fair T' and 'fair V' anchors, have been standardized for use. The fair 'V' anchor, which is more popular, is shown in Fig. below. The creep anchor should fit snugly against the sleeper for it to be full;-effective. The following measures are also helpful in reducing creep,

- (a) The track should be well maintained—sleepers should be properly packed and the crib and shoulder ballast should be well compacted.

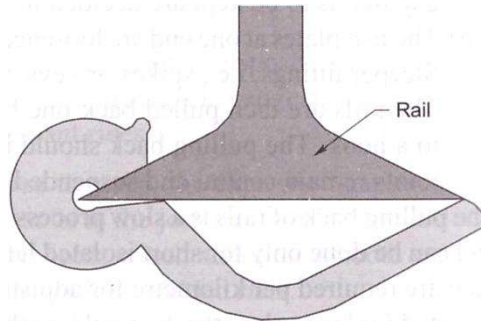

(b) A careful lookout should be kept for jammed joints that exist in series. In the case of a fish-plated track, more than six consecutive continuously jammed joints should not be permitted. In the case of SWR tracks, more than two consecutive jammed joints should not be permitted at rail temperatures lower than the maximum daily temperature (T_m) in the case of zones I and II and lower than $(T_m - 5^\circ\text{C})$ in the case of zones III and IV. Regular adjustment may be necessitated on girder bridges.

(c) Anticreep bearing plates should be provided on wooden sleepers to arrest creep, but joints sleepers should have standard canted bearing plates with rail screws.

Lecture-15

RAILWAY ALIGNMENT

INTRODUCTION

Geometric design of a railway track discusses all those parameters which affect the geometry of the track. These parameters are as follows:

1. Gradients in the track, including grade compensation, rising gradient, and falling gradient
2. Curvature of the track, including horizontal and vertical curves, transition curves, sharpness of the curve in terms of radius or degree of the curve, cant or superelevation on curves, etc.
3. Alignment of the track, including straight as well as curved alignment

It is very important for tracks to have proper geometric design in order to ensure the safe and smooth running of trains at maximum permissible speeds, carrying the heaviest axle loads. The speed and axle load of the train are very important and sometimes are also included as parameters to be considered while arriving at the geometric design of the track.

NECESSITY FOR GEOMETRIC DESIGN

The need for proper geometric design of a track arises because of the following considerations:

- (a) To ensure the smooth and safe running of trains
- (b) To achieve maximum speeds
- (c) To carry heavy axle loads
- (d) To avoid accidents and derailments due to a defective permanent way
- (e) To ensure that the track requires least maintenance
- (f) For good aesthetics

DETAILS OF GEOMETRIC DESIGN OF TRACK

The geometric design of the track deals with alignment of railway track and Curves Details regarding curves and their various aspects.

GRADIENTS

Gradients are provided to negotiate the rise or fall in the level of the railway track. A rising gradient is one in which the track rises in the direction of movement of traffic and in a down or falling gradient the track loses elevation the direction of movement of traffic.

A gradient is normally represented by the distance travelled for a rise or fall of one unit. Sometimes the gradient is indicated as per cent rise or fall. For example, if there is a rise of 1 m in 400 m, the gradient is 1 in 400 or 0.25 per cent.

Gradients are provided to meet the following objectives:

- (a) To reach various stations at different elevations
- (b) To follow the natural contours of the ground to the extent possible
- (c) To reduce the cost of earthwork

The following types of gradients are used on the railways:

- (a) Ruling gradient
- (b) Pusher or helper gradient
- (c) Momentum gradient
- (d) Gradients in station yards

Ruling Gradient

The ruling gradient is the steepest gradient that exists in a section. It determines the maximum load that can be hauled by a locomotive on that section. While deciding the ruling gradient of a section, it is not only the severity of the gradient, but also its length as well as its position with respect to the gradients on both sides that have to be taken into consideration. The power of the locomotive to be put into service on the track also plays an important role in taking this decision, as the locomotive should have adequate power to haul the entire load over the ruling gradient at the maximum permissible speed.

In plain terrain: 1 in 150 to 1 in 250

In hilly terrain: 1 in 100 to 1 in 150

Once a ruling gradient has been specified for a section, all other gradients provided in that section should be flatter than the ruling gradient after making due compensation for curvature.

Pusher or Helper Gradient

In hilly areas, the rate of rise of the terrain becomes very important when trying to reduce the length of the railway line and, therefore, sometimes, gradients steeper than the ruling gradient are provided to reduce the overall cost. In such situations, one locomotive is not adequate to pull the entire load, and an extra locomotive is required.

When the gradient of the ensuing section is so steep as to necessitate the use of an extra engine for pushing the train, it is known as a pusher or helper gradient. Examples of pusher gradients are the Budni-Barkhera section of Central Railway and the Darjeeling Himalayan Railway section.

Momentum Gradient

The momentum gradient is also steeper than the ruling gradient and can be overcome by a train because of the momentum it gathers while running on the section. In valleys, a falling gradient is sometimes followed by a rising gradient. In such a situation, a train coming down a falling gradient acquires good speed and momentum, which gives additional kinetic energy to the train and allows it to negotiate gradients steeper than the ruling gradient. In sections with momentum gradients there are no obstacles provided in the form of signals, etc., which may bring the train to a critical juncture.

Gradients in Station Yards

The gradients in station yards are quite flat due to the following reasons:

- (a) It prevents standing vehicles from rolling and moving away from the yard due to the combined effect of gravity and strong winds.
- (b) It reduces the additional resistive forces required to start a locomotive to the extent possible.

It may be mentioned here that generally, yards are not levelled completely and certain flat gradients are provided in order to ensure good drainage. The maximum gradient prescribed in station yards on Indian Railways is 1 in 400, while the recommended gradient is 1 in 1000.

GRADE COMPENSATION ON CURVES

Curves provide extra resistance to the movement of trains. As a result, gradients are compensated to the following extent on curves:

- (a) On BG tracks, 0.04 per cent per degree of the curve or $70/R$, whichever is minimum
- (b) On MG tracks, 0.03 per cent per degree of curve or $52.5/R$, whichever is minimum
- (c) On NG tracks, 0.02 per cent per degree of curve or $35/R$, whichever is minimum

where R is the radius of the curve in metres. The gradient of a curved portion of the section should be flatter than the ruling gradient because of the extra resistance offered by the curve.

Lecture-16

HORIZONTAL CURVES

Introduction

Curves are introduced on a railway track to bypass obstacles, to provide longer and easily traversed gradients, and to pass a railway line through obligatory or desirable locations. Horizontal curves are provided when a change in the direction of the track is required and vertical curves are provided at points where two gradients meet or where a gradient meets level ground. To provide comfortable ride on a horizontal curve, the level of the outer rail is raised above the level of the inner rail. This is known as super elevation.

CIRCULAR CURVES

This section describes the defining parameters, elements, and methods of setting out circular curves.

Radius or degree of a curve

A curve is defined either by its radius or by its degree. The degree of a curve (D) is the angle subtended at its centre by a 30.5 m or 100 ft arc.

The value of the degree of the curve can be determined as indicated below.

Circumference of a circle = $2\pi R$

Angle subtended at the centre by a circle with this circumference = 360°

Angle subtended at the centre by a 30.5 m arc, or degree of curve = $360^\circ/2\pi R \times 30.5$

$$= 1750/R \text{ (approximately } R \text{ is in meter)}$$

In cases where the radius is very large, the arc of a circle is almost equal to the chord connecting the two ends of the arc. The degree of the curve is thus given by the following formulae:

$$D = 1750/R \text{ (when } R \text{ is in metres)}$$

$$D = 5730/R \text{ (when } R \text{ is in feet)}$$
 A 2° curve, therefore, has a radius of $1750/2 = 875$ m.

Relationship between radius and versine of a curve

Versine is the perpendicular distance of the midpoint of a chord from the arc of a circle. The relationship between the radius and versine of a curve can be established as shown in Fig. Below. Let R be the radius of the curve, C be the length of the chord, and V be the versine of a chord of length C .

AC and DE being two chords meeting perpendicularly at a common point B, simple geometry can prove that

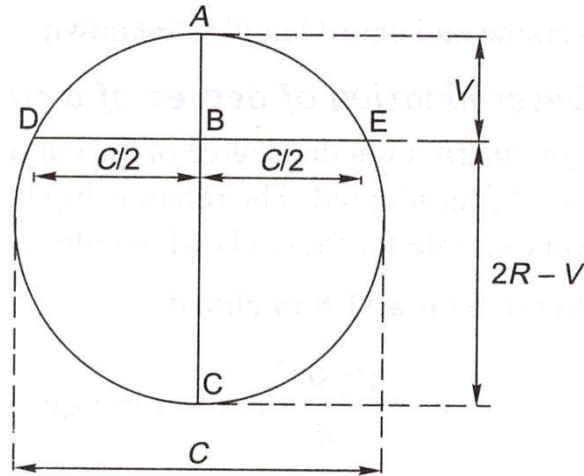

Fig. Relation between radius and versine of a curve

$$AB \times BC = DB \times BE \text{ or } V(2R - V) = (C/2) \times (C/2) \text{ or } 2RV - V^2 = C^2/4$$

V being very small, V^2 can be neglected. Therefore,

$$2RV = C^2/4 \text{ or } V = C^2/8R$$

In above Eqn V, C, and R are in the same unit, say, metres or centimetres. This general equation can be used to determine versines if the chord and the radius of a curve are known.

Maximum degree of a curve

The maximum permissible degree of a curve on a track depends on various factors such as gauge, wheel base of the vehicle, maximum permissible superelevation, and other such allied factors. The maximum degree or the minimum radius of the curve permitted on Indian Railways for various gauges is given in Table below.

Table Maximum permissible degree of curves

| Gauge | On plain track | On turnouts |
|-------|----------------|-------------|
|-------|----------------|-------------|

| | <i>Max. degree</i> | <i>Min. radius (m)</i> | <i>Max. degree</i> | <i>Min. radius (m)</i> |
|----|--------------------|------------------------|--------------------|------------------------|
| BG | 10 | 175 | 8 | 218 |
| MG | 16 | 109 | 15 | 116 |
| NG | 40 | 44 | 17 | 103 |

Elements of a circular curve

In Fig. below, AO and BO are two tangents of a circular curve which meet or intersect at a point O, called *the point of intersection* or *apex*. T₁ and T₂ are the points where the curve touches the tangents, called *tangent points* (TP). OT₁ and OT₂ are the tangent lengths of the curve and are equal in the case of a simple curve. T₁T₂ is the chord and EF is the versine of the same. The angle AOB formed between the tangents AO and OB is called the *angle of intersection* ($\sphericalangle 1$) and the angle BOO₁, is the *angle of deflection* ($\sphericalangle \phi$). The following are some of the important relations between these elements:

$$\sphericalangle 1 + \sphericalangle \phi = 180^\circ$$

$$\text{Tangent } OT_1 = OT_2 = R \tan (\phi/2)$$

$$T_1T_2 = \text{length of long cord} = 2R \sin (\phi/2)$$

$$\text{Length of the curve} = 2\pi R/360 \times \phi = \pi R \phi / 180$$

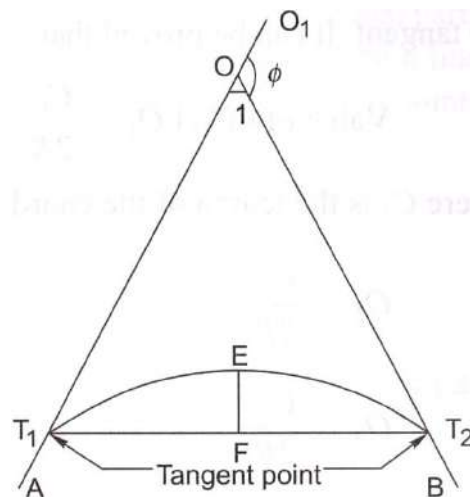

Fig. Elements of a circular curve

Lecture-17

SUPERELEVATION

The following terms are frequently used in the design of horizontal curves.

Superelevation or cant (C_a) It is the difference in height between the outer and the inner rail on a curve. It is provided by gradually raising the outer rail above the level of the inner rail. The inner rail, also known as the gradient rail, is taken as the reference rail and is normally maintained at its original level. The main functions of superelevation are the following:

- (a) To ensure a better distribution of load on both rails
- (b) To reduce the wear and tear of the rails and rolling stock
- (c) To neutralize the effect of lateral forces
- (d) To provide comfort to passengers

Equilibrium speed When the speed of a vehicle negotiating a curved track is such that the resultant force of the weight of the vehicle and of radial acceleration is perpendicular to the plane of the rails, the vehicle is not subjected to any unbalanced radial acceleration and is said to be in equilibrium. This particular speed is called the equilibrium speed.

Maximum permissible speed This is the highest speed permitted to a train on a curve taking into consideration the radius of curvature, actual cant, cant deficiency, cant excess, and the length of transition. On curves where the maximum permissible speed is less than the maximum sectional speed of the section of the line, permanent speed restriction becomes necessary.

Cant deficiency (C_d) It occurs when a train travels around a curve at a speed higher than the equilibrium speed. It is the difference between the theoretical cant required for such high speeds and the actual cant provided.

Cant excess (C_e) It occurs when a train travels around a curve at a speed lower than the equilibrium speed. It is the difference between the actual cant provided and the theoretical cant required for such a low speed.

Cant gradient and cant deficiency gradient These indicate the increase or decrease in the cant or the deficiency of cant in a given length of transition. A gradient of 1 in 1000 means that a cant or a deficiency of cant of 1 mm is attained or lost in every 1000 mm of transition length.

Rate of change of cant or cant deficiency This is the rate at which cant deficiency increases while passing over the transition curve, e.g., a rate of 35 mm per second means that a vehicle will

experience a change in cant or a cant deficiency of 35 mm in each second of travel over the transition when travelling at the maximum permissible speed.

CENTRIFUGAL FORCE ON A CURVED TRACK

A vehicle has a tendency to travel in a straight direction, which is tangential to the curve, even when it moves on a circular curve. As a result, the vehicle is subjected to a constant radial acceleration. Radial acceleration = $a = V^2/R$

where V is the velocity (metres per second) and R is the radius of curve (metres). This radial acceleration produces a centrifugal force which acts in a radial direction away from the centre. The value of the centrifugal force is given by the formula:

$$\text{Force} = \text{mass} \times \text{acceleration}, F = m \times (V^2/R) = (W/g) \times (V^2/R)$$

where F is the centrifugal force (Kilo newton), W is the weight of the vehicle (tonnes), V is the speed (m/s), g is the acceleration due to gravity (m/s^2), and R is the radius of the curve in metres. To counteract the effect of the centrifugal force, the outer rail of the curve is elevated with respect to the inner rail by an amount equal to the *superelevation*. A state of equilibrium is reached when both the wheels exert equal pressure on the rails and the superelevation is enough to bring the resultant of the centrifugal force and the force exerted by the weight of the vehicle at right angles to the plane of the top surface of the rails. In this state of equilibrium, the difference in the heights of the outer and inner rails of the curve is known as *equilibrium superelevation*.

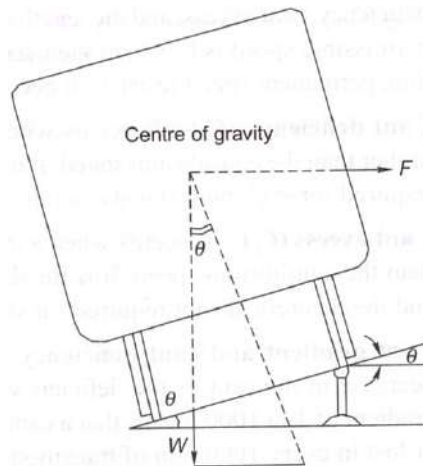

Fig. Equilibrium superelevation

Equilibrium Superelevation

In Fig. above, if θ is the angle that the inclined plane makes with the horizontal line, then superelevation

$$\tan \theta = \text{Superelevation} / \text{Gauge} = e / G$$

$$\tan \theta = \text{Centrifugal force/weight} = F/W$$

From these equations

$$e / G = F / W$$

$$e = f \times G / W$$

$$e = W / g \times V^2 / R \times G / R = GV^2 / gR$$

Here, e is the equilibrium superelevation, G is the gauge, V is the velocity, g is the acceleration due to gravity, and R is the radius of the curve. In the metric system equilibrium superelevation is given by the formula:

$$e = GV^2 / 127R$$

where e is the superelevation in millimetres, V is the speed in km per hour, R is the radius of the curve in metres, and G is the dynamic gauge in millimetres, which is equal to the sum of the gauge and the width of the rail head in millimetres. This is normal to 1750 mm for BG tracks and 1058 mm for MG tracks.

MAXIMUM VALUE OF SUPERELEVATION

The maximum value of superelevation has been laid down based on experiments carried out in Europe on a standard gauge for the overturning velocity, taking into consideration the track maintenance standards. The maximum value of superelevation generally adopted on many railways around the world is one-tenth to one-twelfth of the gauge. The values of maximum superelevation prescribed on Indian Railways are given in Table below.

Table Maximum value of superelvation

| Gauge | Group | Limiting value of cant (mm) | |
|-------|------------|-----------------------------|-------------------------------|
| | | Under normal conditions | With special permission of CE |
| BG | A | 165 | 185 |
| BG | B and C | 165 | - |
| BG | D and E | 140 | - |
| MG | All routes | 90 | 100 |
| NG | | 65 | 75 |

Lecture-18

CANT DEFICIENCY AND NEGATIVE SUPERELEVATION

Introduction

Cant deficiency is the difference between the equilibrium cant that is necessary for the maximum permissible speed on a curve and the actual cant provided. Cant deficiency is limited due to two considerations:

1. Higher cant deficiency causes greater discomfort to passengers
2. Higher cant deficiency leads to greater unbalanced centrifugal force, which in turn leads to the requirement of stronger tracks and fastenings to withstand the resultant greater lateral forces. The maximum values of cant deficiency prescribed on Indian Railways are given in Table below.

Table Allowable cant deficiency

| <i>Gauge</i> | <i>Group</i> | <i>Normal cant deficiency (mm)</i> | <i>Remarks</i> |
|--------------|--------------|------------------------------------|---|
| BG | AandB | 75 | For BG group |
| BG | C, D, and E | 75 | For A and B routes; 1 00 mm cant deficiency permitted only for nominated rolling stock and routes with the approval of the CE |
| MG | All routs | 50 | |
| NG | - | 40 | |

The limiting values of cant excess have also been prescribed. Cant excess should not be more than 75 mm on BG and 65 mm on MG for all types of rolling stock. Cant excess should be worked out taking into consideration the booked speed of the trains running on a particular section. In the case of a section that carries predominantly goods traffic, cant excess should be kept low to minimize wear on the inner rail. Table below lists the limiting values of the various parameters that concern a curve.

NEGATIVE SUPERELEVATION

When the main line lies on a curve and has a turnout of contrary flexure leading to a branch line, the superelevation necessary for the average speed of trains running over the main line curve cannot be provided. In **Fig.** below, AB, which is the outer rail of the main line curve, must be higher than CD. For the branch line, however CF should be higher than AE or point C should be

higher than point A. These two contradictory conditions cannot be met within one layout. In such cases, the branch line curve has a negative superelevation and, therefore, speeds on both tracks must be restricted, particularly on the branch line.

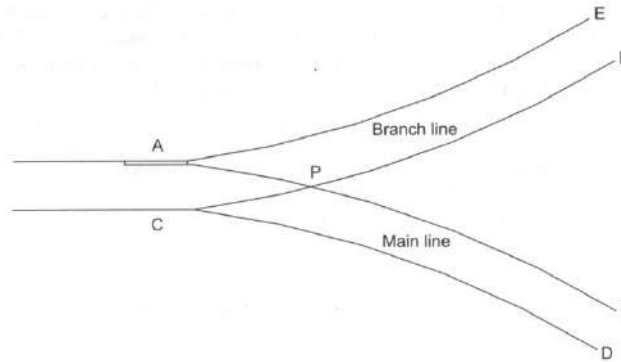

Fig: Negative superelevation

The provision of negative superelevation for the branch line and the reduction in speed over the main line can be calculated as follows:

(i) The equilibrium superelevation for the branch line curve is first calculated using the formula

$$e = GV^2 / 127R$$

(ii) The equilibrium superelevation e is reduced by the permissible cant deficiency C_d and the resultant superelevation to be provided is

$$x = e - C_d$$

where x is the superelevation, e is the equilibrium superelevation, and C_d is 75 mm for BG and 50 mm for MG. The value of C_d is generally higher than that of e , and, therefore, x is normally negative. The branch line thus has a negative superelevation of x .

(iii) The maximum permissible speed on the main line, which has a superelevation of x , is then calculated by adding the allowable cant deficiency ($x + C_d$). The safe speed is also calculated and the smaller of the two values is taken as the maximum permissible speed on the main line curve.

SAFE SPEED ON CURVES

For all practical purposes safe speed refers to a speed which protects a carriage from the danger of overturning and derailment and provides a certain margin of safety. Earlier it was calculated empirically by applying Martin's formula:

For BG and MG Transitioned curves

$$V = 3.65(R - 6)^{1/2}$$

where V is the speed in km per hour and R is the radius in metres.

Non-transitioned curves

Safe speed = four-fifths of the speed calculated using Eqn. above

For NG Transitioned curves

$$V = 3.65(R - 6)^{1/2} \text{ (subject to a maximum of 50 kmph).}$$

Non-transitioned curves

$$V = 2.92(R - 6)^{1/2} \text{ (subject to a maximum of 40 kmph).}$$

Indian Railways no longer follows this concept of safe speed on curves or the stipulations given here.

New Formula for Determining Maximum Permissible Speed on Transitioned Curves

Earlier, Martin's formula was used to work out the maximum permissible speed or safe speed on curves. This empirical formula has been changed by applying a formula based on theoretical considerations as per the recommendations of the committee of directors, chief engineers, and the ACRS. The maximum speed for transitioned curves is now determined as per the revised formulae given below:

For BG

$$V = ((C_a + C_d) \times R / 13.76)^{1/2} = 0.27((C_a + C_d) \times R)^{1/2}$$

where V is the maximum speed in km per hour, C_a is the actual cant in millimetres, C_d is the permitted cant deficiency in millimetres, and R is the radius in millimetres. This equation is derived from Eqn for equilibrium superelevation and is based on the assumption that $G = 1750$ mm, which is the centre-to-centre distance between the rail heads of a BG track with 52 g rails.

For MG

$$V = 0.347((C_a + C_d) \times R)^{1/2}$$

This is based on the assumption that the centre-to-centre (c/c) distance between the rail heads of an MG track is 1058 mm.

For NG (762 mm.)

$$V = 3.65(R - 6)^{1/2} \text{ (subject to a maximum of 50 kmph)}$$

(i) Maximum sanctioned speed of the section This is the maximum permissible speed authorized by the commissioner of railway safety. This is determined after an analysis of the condition of the track, the standard of interlocking, the type of locomotive and rolling stock used, and other such factors.

(ii) Maximum speed of the section based on cant deficiency This is the speed calculated using the formula given in Table above. First, the equilibrium speed is decided after taking various factors into consideration and the equilibrium superelevation (C_a) calculated. The cant deficiency (C_d) is then added to the equilibrium superelevation and the maximum speed is calculated as per this increased superelevation ($C_a + C_d$).

(iii) Maximum speed taking into consideration speed of goods train and cant

excess Cant (C_a) is calculated based on the speed of slow moving traffic, i.e., goods train. This speed is decided for each section after taking various factors into account, but generally its value is 65 km per hour for BG and 50 km per hour for MG.

The maximum value of cant excess (C_e) is added to this cant and it should be ensured that the cant for the maximum speed does not exceed the value of the sum of the actual cant + and the cant excess ($C_a + C_e$).

(iv) Speed corresponding to the length of the transition curves This is the least value of speed calculated after considering the various lengths of transition curves given by the formulae listed in Table below.

Example 1: Calculate the superelevation and maximum permissible speed for a 2° BG transitioned curve on a high-speed route with a maximum sanctioned speed of 110 kmph. The speed for calculating the equilibrium superelevation as decided by the chief engineer is 80 kmph and the booked speed of goods trains is 50 kmph.

Example 2: Calculate the superelevation, maximum permissible speed, and transition length for a 3° curve on a high-speed BG section with a maximum sanctioned speed of 110 kmph. Assume the equilibrium speed to be 80 kmph and the booked speed of the goods train to be 50 kmph.

Lecture-19

LENGTH OF TRANSITION CURVES

Introduction

As soon as a train commences motion on a circular curve from a straight line track, it is subjected to a sudden centrifugal force, which not only causes discomfort to the passengers, but also distorts the track alignment and affects the stability of the rolling stock. In order to smoothen the shift from the straight line to the curve, transition curves are provided on either side of the circular curve so that the centrifugal force is built up gradually as the superelevation slowly runs out at a uniform rate (Fig. below). A transition curve is, therefore, the cure for an uncomfortable ride, in which the degree of the curvature and the gain of superelevation are uniform throughout its length, starting from zero at the tangent point to the specified value at the circular curve. The following are the objectives of a transition curve.

(a) To decrease the radius of the curvature gradually in a planned way from infinity at the straight line to the specified value of the radius of a circular curve in order to help the vehicle negotiate the curve smoothly.

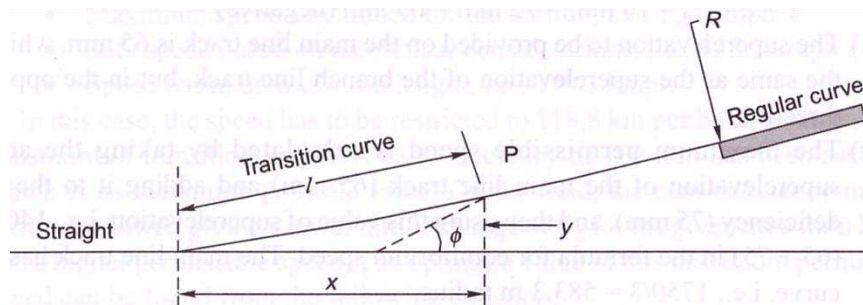

(b) To provide a gradual increase of the superelevation starting from zero at the straight line to the desired superelevation at the circular curve.

(c) To ensure a gradual increase or decrease of centrifugal forces so as to enable the vehicles to negotiate a curve smoothly.

Requirements of an Ideal Transition Curve

The transition curve should satisfy the following conditions.

- (a) It should be tangential to the straight line of the track, i.e., it should start from the straight part of the track with a zero curvature.
- (b) It should join the circular curve tangentially, i.e., it should finally have the same curvature as that of the circular curve.
- (c) Its curvature should increase at the same rate as the superelevation.
- (d) The length of the transition curve should be adequate to attain the final superelevation, which increases gradually at a specified rate.

Types of Transition Curves

The types of transition curves that can be theoretically provided are described here. The shapes of these curves are illustrated in Fig. below.

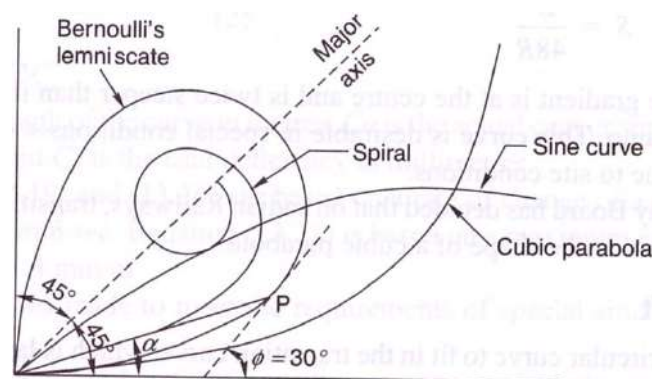

Euler's spiral This is an ideal transition curve, but is not preferred due to mathematical complications. The equation for Euler's spiral is:

$$\phi = \frac{l^2}{2RL}$$

Cubical spiral This is also a good transition curve, but quite difficult to set on the field.

$$y = \frac{l^2}{6RL}$$

Bernoulli's lemniscate In this curve, the radius decreases as the length increases and this causes the radial acceleration to keep on falling. The fall is, however, not uniform beyond a 30° deflection angle. This curve is not used on railways.

Cubic parabola Indian Railways mostly uses the cubic parabola for transition curves. The equation of the cubic parabola is: $y = \frac{x^3}{6RL}$

In this curve, both the curvature and the cant increase at a linear rate. The cant of the transition curve from the straight to the curved track is so arranged that the inner rail continues to be at the same level while the outer rail is raised in the linear form throughout the length of the curve. A straight line ramp is provided for such transition curves.

The notations used in above Eqs are as follows: ϕ is the angle between the straight line track and the tangent to the transition curve, l is the distance of any point on the transition curve from the take-off point, L is the length of the transition curve, x is the horizontal coordinate on the transition curve, y is the vertical coordinate on the transition curve, and R is the radius of the circular curve.

S-shaped transition curve In an S-shaped transition curve, the curvature and superelevation assume the shape of two quadratic parabolas. Instead of a straight line ramp, an S-type parabola ramp is provided with this transition curve. The special feature of this curve is that the shift required ('shift' is explained in the following section) in this case is only half of the normal shift provided for a straight line ramp. The value of shift is:

$$S = L^2/48R$$

Further, the gradient is at the centre and is twice steeper than in the case of a straight line ramp. This curve is desirable in special conditions—when the shift is restricted due to site conditions. The Railway Board has decided that on Indian Railways, transition curves will normally be laid in the shape of a cubic parabola.

LENGTH OF TRANSITION CURVE

The length of the transition curve is length along the centre line of the track from its meeting point with the straight to that of the circular curve. This length is inserted at the junction half in the straight and half in the curve. Let, L = Length of transition curve in metres e = Actual cant or superelevation in cm. D = Cant deficiency for maximum speed in cm and V = Maximum speed in kmph.

Indian Railways specify that *greatest* of the following lengths should be taken as the length of the transition curve.

$$L = 7.20 e$$

where e = actual superelevation in centimetres. This is based on Arbitrary gradient (1 in 720)

$$L = 0.073 D \times V_{max}$$

The length of the transition curve prescribed on Indian Railways is the maximum of the following three values:

$$L = 0.008C_a \times V_m = C_a \times V_m / 125$$

$$L = 0.008C_d \times V_m = C_d \times V_m / 125$$

$$L = 0.72C_a$$

Where L is the length of the curve in metres, C_a is the actual cant or superelevation in millimetres, and C_d is the cant deficiency in millimetres. Above first two equations are based on a rate of change of a cant or cant deficiency of 35 mm/sec. Third equation is based on a maximum cant gradient of 1 in a 720 or 1.4 mm/m.

Example: A curve of 600 m radius on a BG section has a limited transition of 40 m length. Calculate the maximum permissible speed and superelevation for the same. The maximum sectional speed (MSS) is 100 kmph.

Lecture-20

VERTICAL CURVES

Introduction

Vertical Curves. They are of two types :

- (i) Summit curves. (ii) Sag or Valley curves.

Whenever, there is a change in the gradient of the track, an angle is formed at the junction of the gradients. This vertical kink at the junction is smoothed by the use of curve, so that bad lurching is not experienced. The effects of change of gradient cause variation in the draw bar pull of the locomotive.

When a train climbs a certain upgrade at a uniform speed and passes over the summit of the curve, an acceleration begins to act upon it and makes the trains to move faster and increases the draw bar pull behind each vehicle, causing a variation in the tension in the couplings.

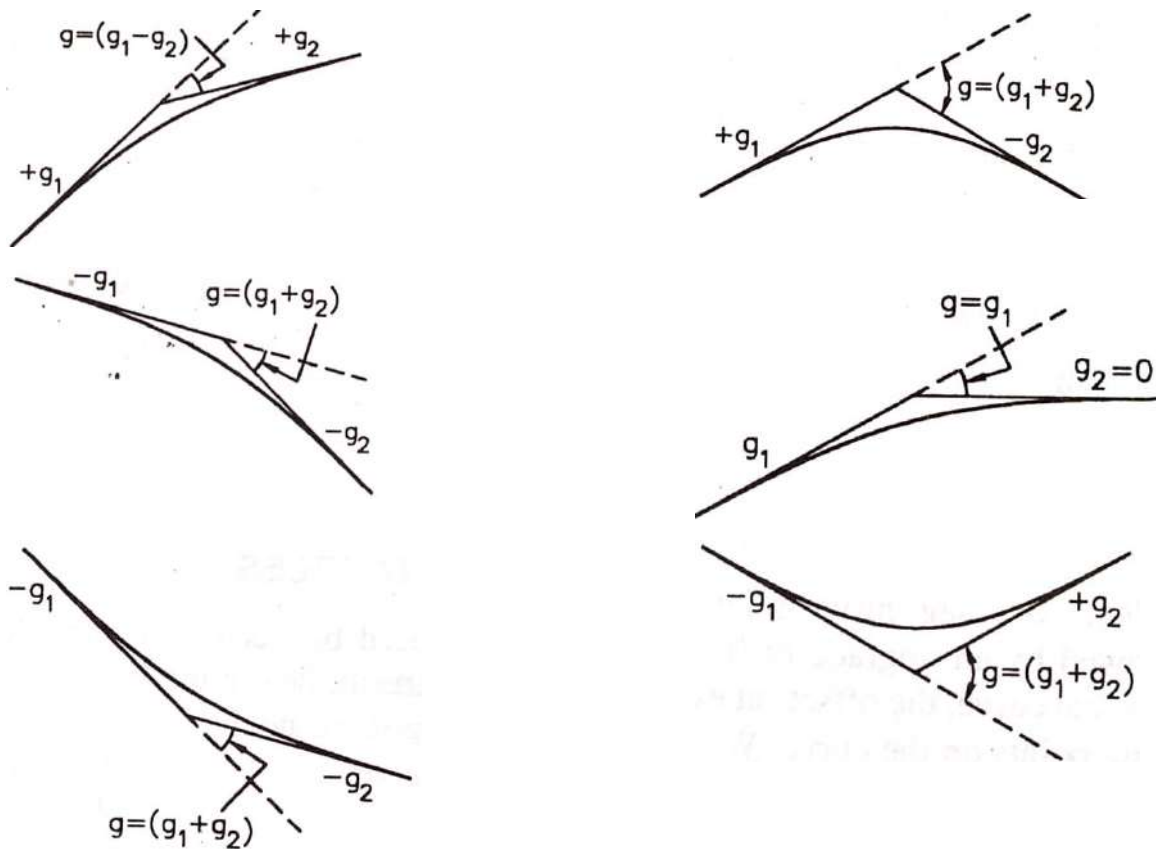

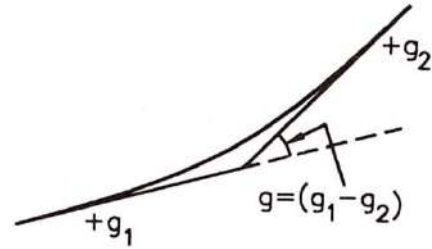
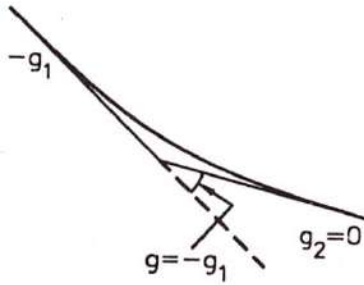

When a train passes over a sag, the front of the train ascends an up-grade while rear vehicles tend to compress the couplings and buffers, and when the whole train has passed the sag, the couplings are again in tension causing a jerk. Due to above reasons, it is essential to introduce a vertical curve at each sag and at each summit or apex.

A parabolic curve is set out, tangent to the two intersecting grades, with its apex at a level halfway between the points of intersection of the grade line and the average elevation of the two tangent points. The length of the vertical curve depends upon the algebraic difference in grade as shown in figure above and determined by the rate of change gradient of the line.

Lecture-21

POINT AND CROSSING-I

Points and crossings are provided facilitates the change of railway vehicles from one track to another. The tracks may be parallel, diverging, or converging to each other. Points and crossings are necessary due to the inside flanges of wheels of railway vehicles and, therefore require special arrangement to navigate their way on the rails. The points or switches aid in diverting the vehicles and the crossings provide gaps in the rails so as to help the flanged wheels to roll over them. A complete set of points and crossings, along with lead rails, is called a *turnout*.

IMPORTANT TERMS

The following terms are often used in the design of points and crossings.

Turnout It is an arrangement of points and crossings with lead rails by means of which the rolling stock may be diverted from one track to another. Figure (a) shows the various constituents of a turnout. The details of these constituents are given in Table below.

Table: Parts of a turnout

| <i>Name of the main assembly</i> | <i>Various constituents of the assembly</i> |
|----------------------------------|---|
| Set of switches | A pair of stock rails, a pair of tongue rails, a pair of heel blocks, several slide chairs, two or more stretcher bars, and a gauge tie plate |
| Crossing | A nose consisting of a point rail and splice rails, two wing rails, and two check rails |
| Lead rails | Four sets of lead rails |

Direction of a turnout A turnout is designated as a right-hand or a left-hand turnout depending on whether it diverts the traffic to the right or to the left. In Fig. (a), the turnout is a right-hand turnout because it diverts the traffic towards the right side. Figure (b) shows a left-hand turnout. The direction of a point (or turnout) is known as *the facing direction* if a vehicle approaching the turnout or a point has to first face the thin end of the switch. The direction is *trailing direction* if the vehicle has to negotiate a switch in the trailing direction, that is, the vehicle first negotiates the crossing and then finally traverses on the switch from its thick end to its thin end. Therefore, when standing at the toe of a switch, if one looks in the direction of the crossing, it is called *the facing direction* and the opposite direction is called the *trailing direction*.

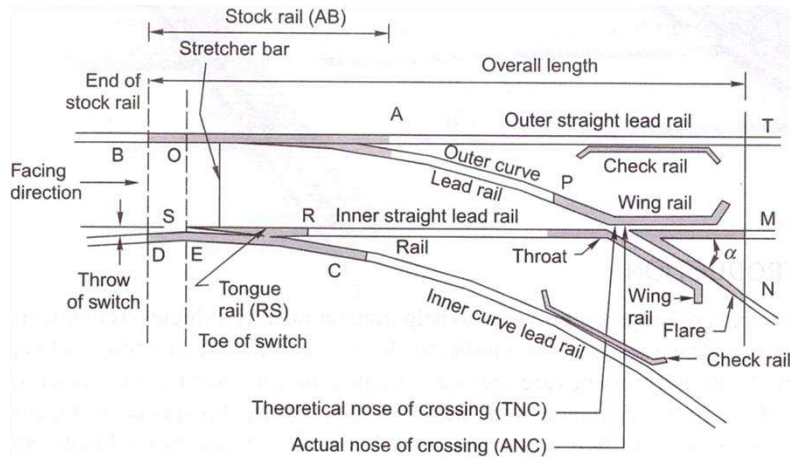

Fig. (a) Constituents of a turnout

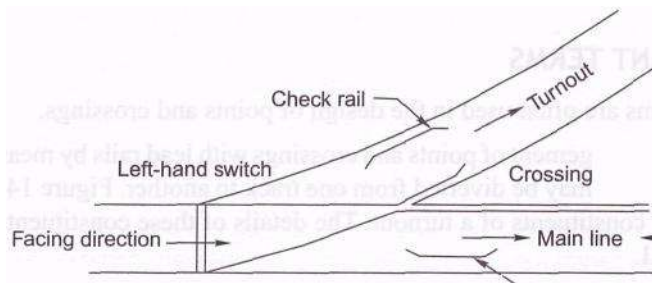

Fig. (b) Left-hand turnout

Tongue rail It is a tapered movable rail, made of high-carbon or -manganese steel to withstand wear. At its thicker end, it is attached to a running rail. A tongue rail is also called a switch rail.

Stock rail It is the running rail against which a tongue rail operates.

Points or switch A pair of tongue and stock rails with the necessary connections and fittings forms a switch.

Crossing It is a device introduced at the junction where two rails cross each other to permit the wheel flange of a railway vehicle to pass from one track to another.

SWITCHES

A set of points or switches consists of the following main constituents (Fig. below).

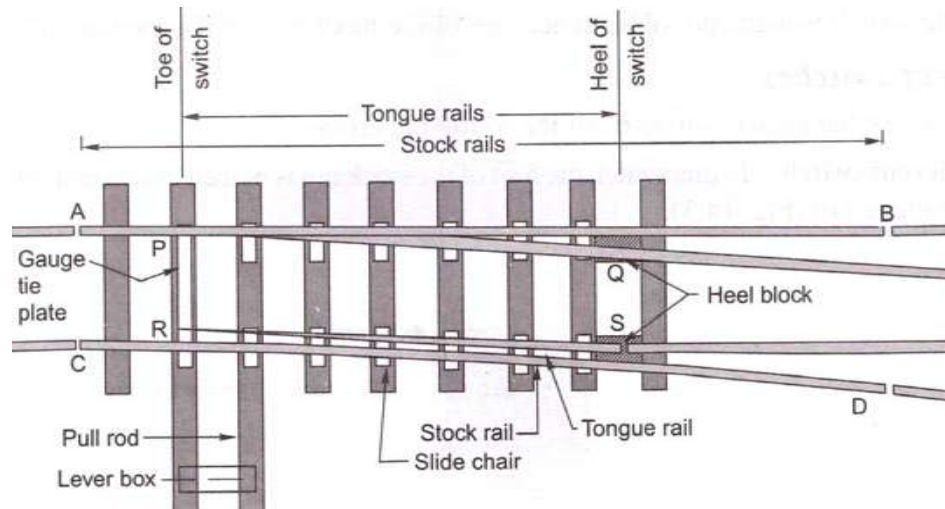

Fig. Details of a switch

- (a) A pair of stock rails, AB and CD, made of medium-manganese steel.
- (b) A pair of tongue rails, PQ and RS, also known as switch rails, made of medium-manganese steel to withstand wear. The tongue rails are machined to a very thin section to obtain a snug fit with the stock rail. The tapered end of the tongue rail is called the toe and the thicker end is called the heel.
- (c) A pair of heel blocks which hold the heel of the tongue rails is held at the standard clearance or distance from the stock rails.
- (d) A number of slide chairs to support the tongue rail and enable its movement towards or away from the stock rail.
- (e) Two or more stretcher bars connecting both the tongue rails close to the toe, for the purpose of holding them at a fixed distance from each other.
- (f) A gauge tie plate to fix gauges and ensure correct gauge at the points.

Types of Switches

Switches are of two types, namely stud switch and split switch. In a stud type of switch, no separate tongue rail is provided and some portion of the track is moved from one side to the other side. Stud switches are no more in use on Indian Railways. They have been replaced by split switches. These consist of a pair of stock rails and a pair of tongue rails. Split switches may also be of two types—loose heel type and fixed heel type. These are discussed below.

Loose heel type

Fixed heel type

The toe of the switches may be of the following types.

Undercut switch In this switch the foot of the stock rail is planned to accommodate the tongue rail (Fig. below).

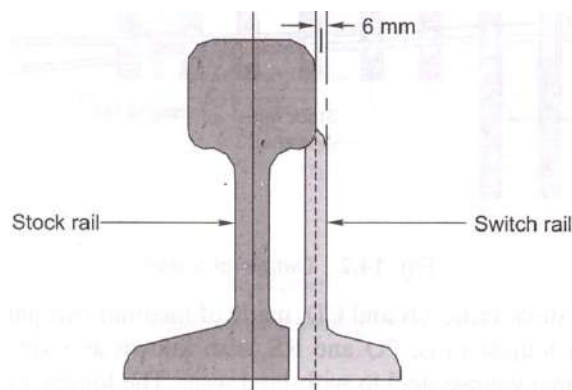

Fig. Undercut switch

Overriding switch In this case, the stock rail occupies the full section and the tongue rail is planed to a 6 mm (0.25")-thick edge, which overrides the foot of the stock rail (Fig. below).

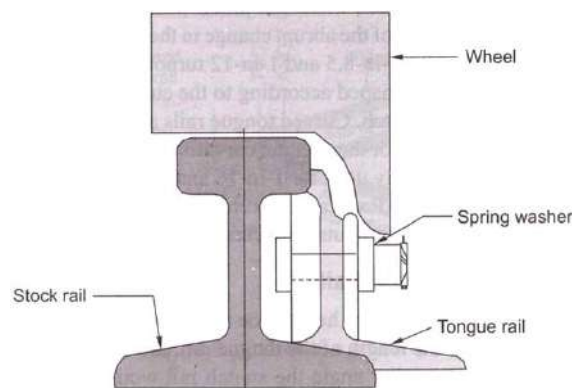

Fig. Overriding switch

Lecture-22

POINT AND CROSSING-II

Introduction

A tongue rail may be either straight or curved. Straight tongue rails have the advantage that they are easily manufactured and can be used for right-hand as well as left-hand turnouts. However, trains get jolted while negotiating with tongue rail turnouts because of the abrupt change in the alignment. Straight rails are normally used for 1-in-8.5 and 1-in-12 turnouts on Indian Railways.

Curved tongue rails are shaped according to the curvature of the turnout fit the toe to the heel of the switch. Curved tongue rails allow for smooth trains, but can only be used for the specific curvature for which they are Curved switches are normally used for 1-in-16 and 1-in-20 IRS (Indian Standard) turnouts on Indian Railways. Recently Indian Railways has also laying 1-in-8.5 and 1-in-12 turnouts with curved switches on important li

Length of Tongue Rails

The length of a tongue rail from heel to toe varies with the gauge and the switch. The longer the length of the tongue rail, the smoother the entry to the switch because of the smaller angle the switch rail would make with the fixed heel divergence. The longer length of the tongue rail, however, occupies too much layout space in station yards where a number of turnouts have to be laid in space. The length of the tongue rail should be more than the rigid wheel a four-wheeled wagon to preclude the possibility of derailment in case the move from their position when a train is running on the switch. Table below the standard lengths of switches (tongue rails) for BG and MG tracks.

Table: Length of tongue rail

| Gauge and type | Length of tongue rail (mm) | | | | |
|----------------|----------------------------|------------------|----------------|----------------|--------|
| | 1-in-8.5 straight | 1-in-12 straight | 1-in-12 curved | 1-in-16 Curved | |
| BG (90 R) | 4725 | 6400 | 7730 | 9750 | 1.1150 |
| MG (75 R) | 4116* | 5485* | 6700 | | |

* These dimensions hold good for NG tracks also.

CROSSING

A crossing or frog is a device introduced at the point where two gauge faces cross each other to permit the flanges of a railway vehicle to pass from one tract to another (Fig. below). To achieve this objective, a gap is provided from the throat to the nose of the crossing, over which the flanged wheel glides or jumps. In order to ensure that this flanged wheel negotiates the gap properly and does not strike the nose, the other wheel is guided with the help of check rails. A crossing consists of the following components, shown in Fig. below.

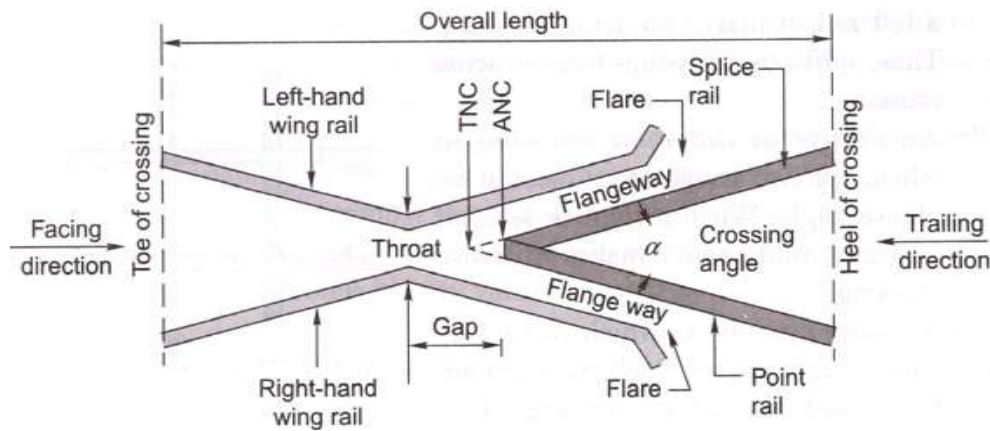

Fig. Details of a crossing

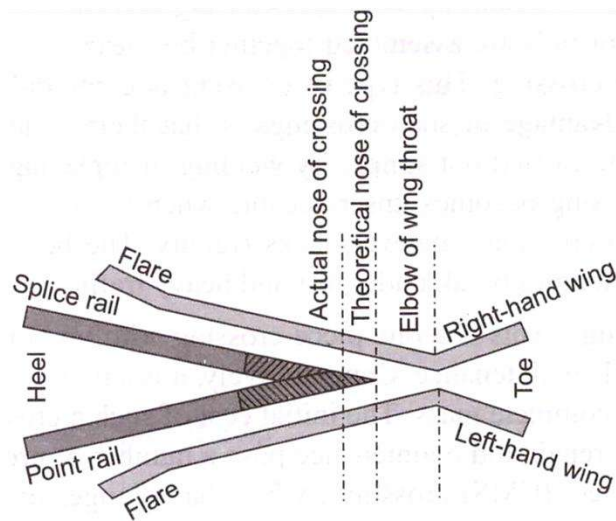

Fig. Point rail and splice rail

(a) Two rails, point rail and splice rail, which are machined to form a nose. The point rail ends at the nose, whereas the splice rail joins it a little behind the nose. Theoretically, the point rail

should end in a point and be made as thin as possible, but such a knife edge of the point rail would break off under the movement of traffic. The point rail, therefore, has its fine end slightly cut off from a blunt nose, with a thickness of 6 mm (1/4"). The toe of the blunt nose is called the **actual nose of crossing** (ANC) and the theoretical point where the gauge faces from both sides intersect is called the **theoretical nose of crossing** (TNC). The 'V rail is planed to a depth of 6 mm (1/4") at the nose and runs out in 89 mm to stop a wheel running in the facing direction from hitting the nose.

(b) Two wing rails consisting of a right-hand and a left-hand wing rail that converge to form a throat and diverge again on either side of the nose. Wing rails are flared at the ends to facilitate the entry and exit of the flanged wheel in the gap.

(c) A pair of check rails to guide the wheel flanges and provide a path for them, thereby preventing them from moving sideways, which would otherwise may result in the wheel hitting the nose of the crossing as it moves in the facing direction.

Types of Crossings

A crossing may be of the following types.

- (a) **An acute angle crossing** or 'V crossing
- (b) **An obtuse or diamond crossing.**
- (c) **A square crossing (Fig. below).**

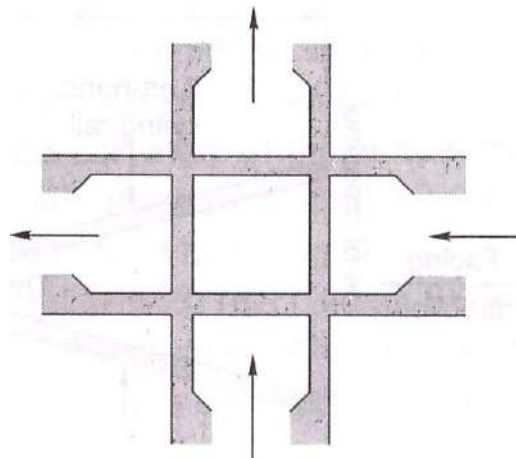

Fig. Square crossing also be classified as follows.

For manufacturing purposes, crossings can also be classified as follows.

- Built-up crossing
- Cast steel crossing
- Combined rail and cast crossing

NUMBER AND ANGLE OF CROSSING

A crossing is designated either by the angle the gauge faces make with each other or, more commonly, by the number of the crossing, represented by N . There are three methods of measuring the number of a crossing, and the value of N also depends upon the method adopted. All these methods are illustrated below.

Centre line method

This method is used in Britain and the US. In this method, N is measured along the centre line of the crossing.

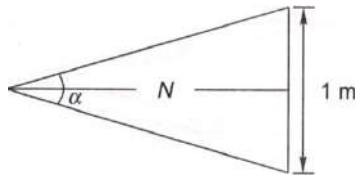

Right angle method

This method is used on Indian Railways. In this method, N is measured along the base of a right-angled triangle. This method is also called Coles method.

$$\cot \alpha/2 - N = N/1/2 \text{ or } N = 1/2 \cot \alpha/2$$

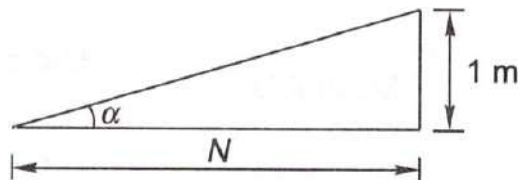

$$\cot \alpha = N/1 \text{ or } N = \cot \alpha$$

Isosceles triangle method

In this method, N is taken as one of the equal sides of an isosceles triangle.

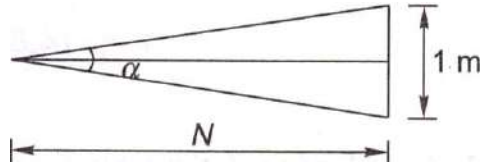

$$\sin \alpha/2 = \frac{1}{2N} \text{ or } N = \frac{1}{2\sin \alpha/2}$$

$$\operatorname{Cosec} \alpha/2 = 2N$$

$$N = \frac{1}{2} \operatorname{Cosec} \alpha/2$$

The right angle method used on Indian Railways, in which TV is the cotangent of the angle formed by two gauge faces, gives the smallest angle for the same value of N .

To determine the number of a crossing-on site, the point where the offset gauge face of the turnout track is 1 m is marked. The distance of this point (in metres) from the theoretical nose of crossing gives N .

Lecture-23

TURNOUTS

Introduction

The simplest arrangement of points and crossing can be found on a turnout taking off from a straight track. There are two standard methods prevalent for designing a turnout. These are the (a) Coles method and (b) IRS method.

These methods are described in detail in the following sections.

The important terms used in describing the design of turnouts are defined as follows:

Curve lead (CL) This is the distance from the tangent point (T) to the theoretical nose of crossing (TNC) measured along the length of the main track.

Switch lead (SL) This is the distance from the tangent point (T) to the heel of the switch (TL) measured along the length of the main track.

Lead of crossing (L) This is the distance measured along the length of the main track as follows:

Lead of crossing (L) = curve lead (CL) - switch lead (SL)

Gauge (G) This is the gauge of the track.

Heel divergence (d) This is the distance between the main line and the turnout side at the heel.

Angle of crossing (a) This is the angle between the main line and the tangent of the turnout line.

Radius of turnout (R) This is the radius of the turnout. It may be clarified that the radius of the turnout is equal to the radius of the centre line of the turnout (/?,) plus half the gauge width.

$$R = R_j + 0.5G$$

As the radius of a curve is quite large, for practical purposes, R may be taken to be equal to .ft.,

Special fittings with turnouts

Some of the special fittings required for use with turnouts are enumerated as follows:

Distance blocks Special types of distance blocks with fishing fit surfaces are provided at the nose of the crossing to prevent any vertical movement between the wing rail and the nose of the crossing.

Flat bearing plates As turnouts do not have any cant, flat bearing plates are provided under the sleepers

Spherical washers These are special types of washers and consist of two pieces with a spherical point of contact between them. This permits the two surfaces to lie at any angle to each other.

These washers are used for connecting two surfaces that are not parallel to one another. Normally, tapered washers are necessary for connecting such surfaces. Spherical washers can adjust to the uneven bearings of the head or nut of a bolt and so are used on all bolts in the heel and the distance blocks behind the heel on the left-hand side of the track.

Slide chairs These are provided under tongue rails to allow them to move laterally. These are different for ordinary switches and overriding switches.

Grade off chairs These are special chairs provided behind the heel of the switches to give a suitable ramp to the tongue rail, which is raised by 6 mm at the heel.

Gauge tie plates These are provided over the sleepers directly under the toe of the switches, and under the nose of the crossing to ensure proper gauge at these locations.

Stretcher bars These are provided to maintain the two tongue rails at an exact distance.

Coles method

This is a method used for designing a turnout taking off from a straight track (Fig. 14.11). The curvature begins from a point on the straight main track ahead of the toe of the switch at the theoretical toe of switch (TTS) and ends at the theoretical nose of crossing (TNC). The heel of the switch is located at the point where the offset of the curve is equal to the heel divergence. Theoretically, there would be no kinks in this layout, had the tongue rail been curved as also the wing rail up to the TNC. Since tongue rails and wing rails are not curved generally, there are the following three kinks in this layout.

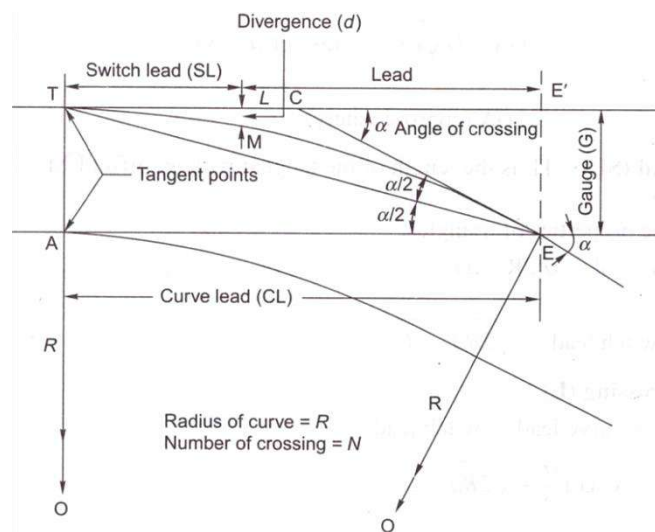

Standard turnouts and permissible speeds

On Indian Railways, normally 1-in-8.5 turnouts are used for goods trains while 1-in-12 and 1-in-16 turnouts are used for passenger trains. Recently 1-in-20 and 1-in-24 turnouts have also been designed by the RDSO, to be used to permit higher speeds for fast trains on the turnout side. The maximum speeds permitted on these turnouts are given in Table below.

Table: Permissible speeds on turnouts

| <i>Gauge</i> | <i>Type of turnout</i> | <i>Switch angle</i> | <i>Permissible speed (kmph)</i> |
|-----------------|------------------------|---------------------------------|---|
| BG | 1 in 8.5 | 1°34'27" | 10* for straight switch and 15 for curved switch for 52/60 kg rails on PSC sleepers |
| BG ^f | 1-in-8.5 | Symmetrical split (SS) 0°27'35" | 30 for curved switch as well as SS with 52/60 kg on PSC sleepers; 15* for curved switch for 52/60 kg on PSC sleepers* |
| BG | 1-in-16 | 1°8'0" 0°24'27" | 50 or 60 ¹ |
| MG | 1-in-8.5 | 1°35'30" 0°29'14" | 10 for straight as well as curved switch |
| MG ^f | 1-in-12 | 1°09'38" 0°24'27" | 15 for straight switch and 15 for partly curved switch |
| MG | 1-in-16 | 0°24'27" | 30 |

Lecture-24

DESIGN OF TURNOUTS

A turnout, after branching off from the main track, may run into various directions of which running parallel to the original track is most common. The design calculation of various turnout are based on following three factors:

- (i) Method of calculating various leads
- (ii) Method employed for crossing angle
- (iii) Type of tongue rail used

Notation used in design calculation

Following notation have been used in various methods for design of turnouts:

CL = Curve lead

= Distance between theoretical nose of the crossing (T.N.C.) and the tangent point “T” measured along the length of main track.

SL = Switch lead

= Distance between tangent point “T” and the heel of the switch (H.S.) measured along the length of the track

L = Lead or crossing lead

= Distance between T.N.C. and the heel of the switch (H.S.) measured along the length of the track

Lead rails, being curved rails, are not measured along their curve length, long their projected length along the straight rail.

Therefore, CL, SL and L, it is clear that

$$CL = SL + L \text{ or } L = CL - SL$$

β = Angle of the switch, i.e. the angle between the gauge faces of switch rail and stock rail

α = Angle of the crossing

d = Heel divergence or clearance

R_0 = Radius of the outer turnout

R = Radius of centre line of the turnout

G = Gauge of the track

N = Number of the crossing

D = Distance between T.N.C. and tangent point of crossing curve

Different method of the turnout design

Three methods are used for design of turnouts

Method-I

The important steps of this method are

- (i) All three leads, CL, SL, and L are calculated. The CL and SL are particularly calculated in this method.
- (ii) Crossing angle (α) calculated using right angle method
- (iii) Crossing curve is considered to start from an imaginary tangent point ahead of actual toe of the switch and end at T.N.C. This arrangement results formation of three kinks,
 - a) Kinks at the toe of the switch. Due to straight tongue rail.
 - b) Kink at heel of the switch. Due to non tangential of tongue rail to the curve.
 - c) Kinks at toe of the crossing. Because the curve is carried theoretically upto T.N.C. but crossing actually is straight.

This design method all three kinds of kinks and was common in the past. But now a days used in unimportant lines and sidings.

Design calculation of method I

Value of gauge (G), Heel divergence (d) and Angle of the crossing (α) are given

Curve lead (CL)

$$CL = 2GN$$

R-Radius

$$\text{Hence } R = R_0 - G/2$$

$$R_0 = 1.5G + 2GN^2$$

$$SL = (2 R_0 d)^{1/2} \quad \text{AS } d^2 \text{ is very small Comair to } 2R_0 d$$

Lead or crossing lead (L)

$$\begin{aligned} L &= CL - SL \\ &= G \cot \alpha/2 - (2 R_0 d)^{1/2} = (2 R_0 G)^{1/2} - (2 R_0 d)^{1/2} \\ &= 2GN - (2 R_0 d)^{1/2} \end{aligned}$$

Heel Divergence (d)

$$\text{From equation } SL = (2 R_0 d)^{1/2} \quad d = (SL)^2 / 2 R_0$$

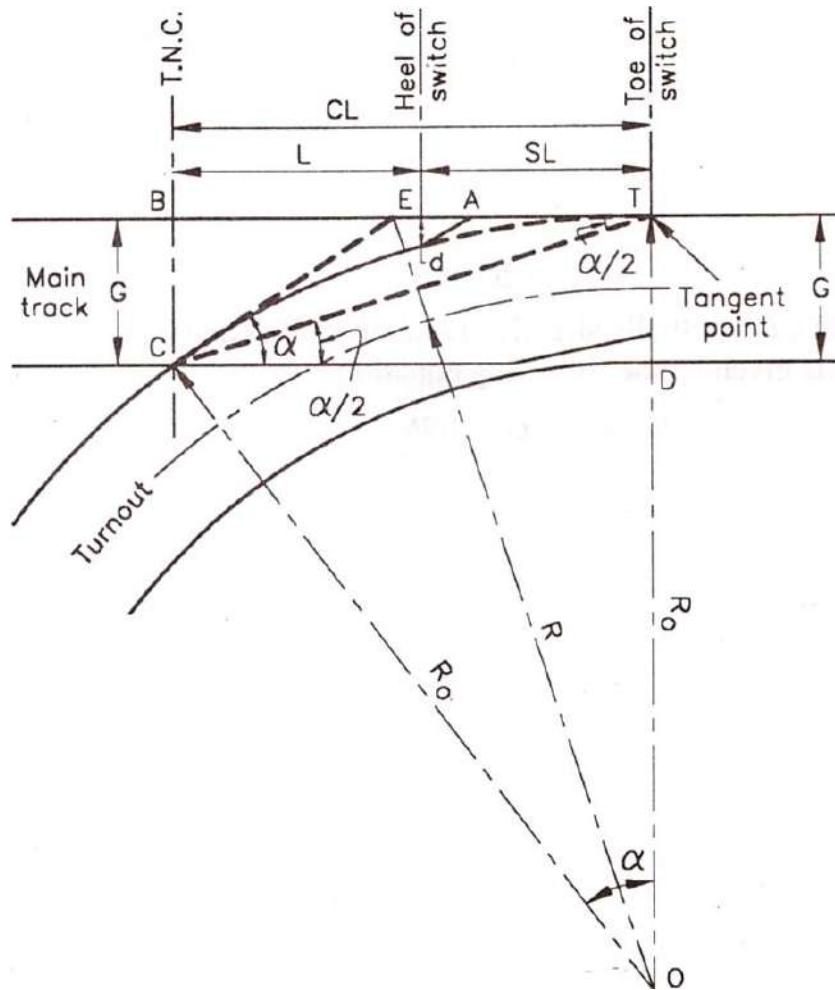

Method II

The important features of this method are

- (i) Only the cross lead "L" is calculated
- (ii) The curve is tangential to the tongue rail. It springs up from heel of switch and ends at T.N.C.
- (iii) Out of three kinks, kinks formed at heel of the switch is removed

This method was common in UK in past

Design Calculation

With given value of gauge (G), d , β (angle of switch) and α , the turnout is designed:

Lead or crossing lead (L):

$$L = (G - d) / \tan (\alpha + \beta) / 2 = (G - d) \cot (\alpha + \beta) / 2$$

R -Radius:

$$R_0 = (G - d) / 2 \sin (\alpha + \beta) / 2 \sin (\alpha - \beta) / 2 = (G - d) / (\cot \beta - \cot \alpha)$$

and $R = R_0 - G/2$

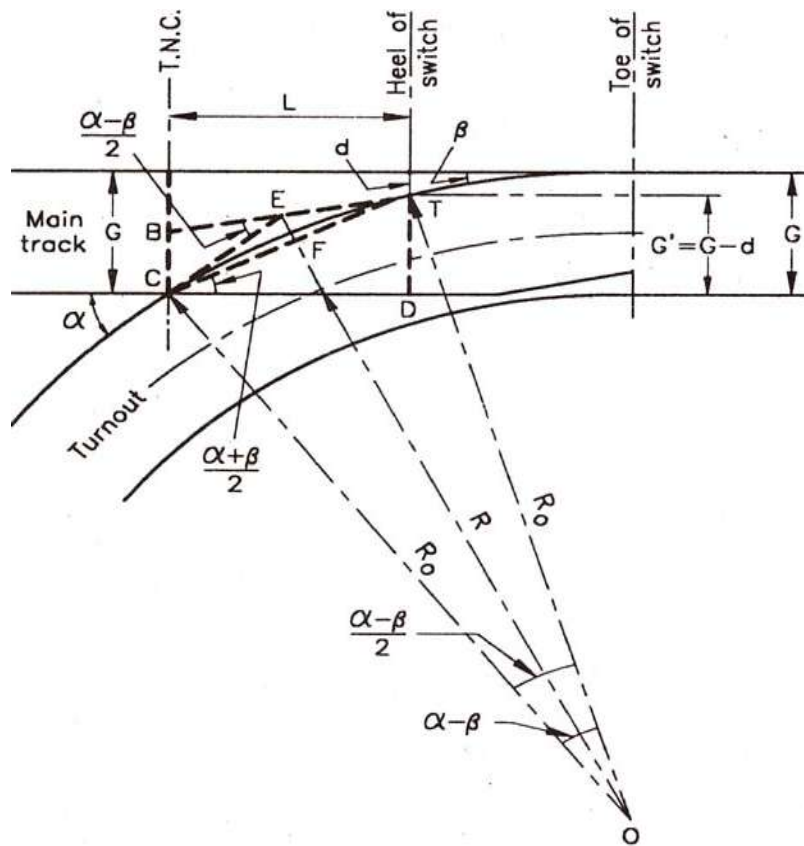

Method III

The important features of this method are

- (i) This method is very similar to method II. But here the straight length at crossing is provided.
- (ii) So one end of the curve is tangential to tongue rail and spring up from the toe of the crossing and is tangential to the straight length of the crossing.
- (iii) In this method kinks at toe of the switch and kinks at heel of the switch are removed.
- (iv) It is suitable where tongue rails and crossing are straight. This method permits the

Design Calculation

Let the straight length of the arms at crossing be $x = T'C$

R-Radius:

With given G, D, α, β and x

$$R_0 = (G - d - x \sin \alpha) / (\cos \beta - \cos \alpha)$$

$$R = R_0 - G/2$$

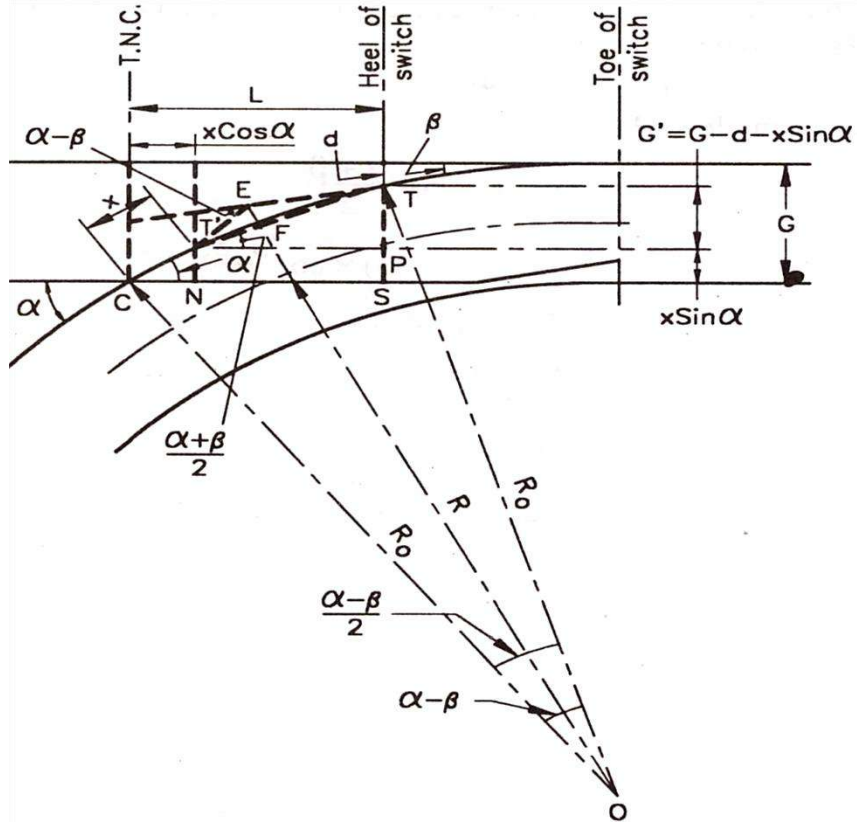

Crossing Lead (L)

$$L = CN + NS = ON + T'P = x \cos \alpha + TP \cot \left(\frac{\alpha + \beta}{2} \right)$$

$$L = x \cos \alpha + G' \cot \left(\frac{\alpha + \beta}{2} \right) = x \cos \alpha + (G - d - x \sin \alpha) \cot \left(\frac{\alpha + \beta}{2} \right)$$

$$d = x \sin \alpha - G - \left((L - x \cos \alpha) / \cot \left(\frac{\alpha + \beta}{2} \right) \right)$$

To get value of method II put $x = 0$

Lecture-25

TRACK JUNCTION

Introduction

Track junctions are formed by the combination of points and crossings. Their main objective is to transfer rail vehicles from one track to another or to enable them to cross from one track to another. Depending upon the requirements of traffic, there can be several types of track junctions with simple track layouts. The most commonly used layouts are discussed in the following sections.

TURNOUT OF SIMILAR FLEXURE

A turnout of similar flexure (Fig.) continues to run in the same direction as the main line curve even after branching off from it. The degree of the turnout curve will be higher than that of the main line curve. The degree and radius of the turnout curve are given by the formulae:

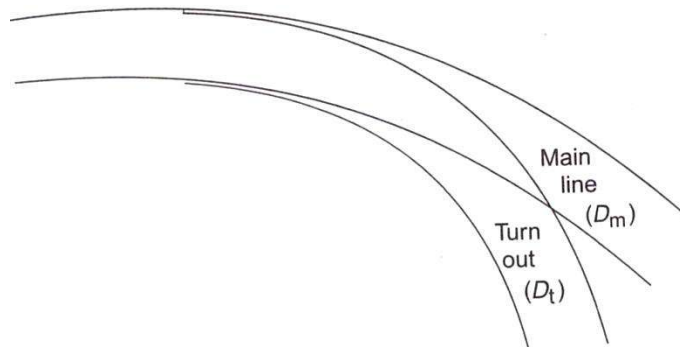

Fig Turnout of similar flexure

where D_s is the degree of the outer rail of the turnout curve from the straight track, D_m is the degree of the rail of the main track on which the crossing lies, i.e., the inner rail in Fig. above, D_t is the degree of the rail of the turnout curve on which the crossing lies, i.e., the outer rail, R_s is the radius of the outer rail of the turnout curve from the straight track, and r_t is the radius of the rail of the turnout curve on which the crossing lies, i.e., the outer rail.

TURNOUT OF CONTRARY FLEXURE

A turnout of contrary flexure (Fig. 15.2) takes off towards the direction opposite to that of the main line curve. In this case, the degree and radius of the turnout curve are given by the following formulae:

$$D_t = D_s - D_m$$

$$R_t = R_s R_m / (R_m - R_s)$$

Here, D_m is the degree of the rail of the main track on which the crossing lies, i.e., the outer rail in Fig. below.

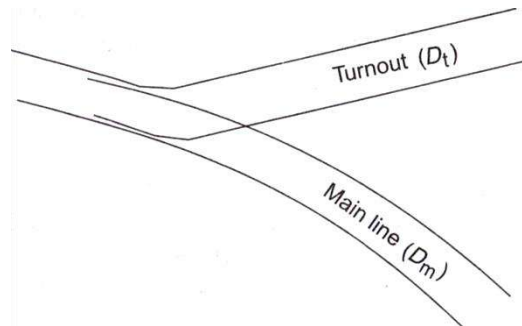

Fig. Turnout of contrary flexure

SYMMETRICAL SPLIT

"When a straight track splits up in two different directions with equal radii, the layout is known as a symmetrical split (Fig. below). In other words, a symmetrical split is a contrary flexure in which the radii of the two curves are the same.

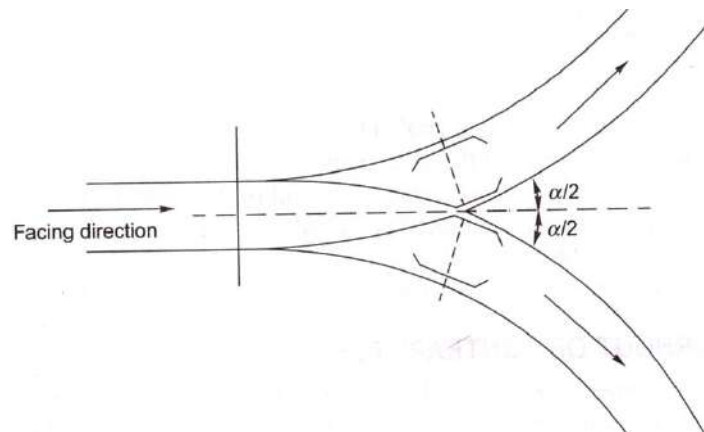

Fig. Symmetrical split

THREE-THROW SWITCH

In a three-throw arrangement, two turnouts take off from the same point of a main line track. Three-throw switches are used in congested goods yards and at entry points to locomotive yards, where there is much limitation of space. A three-throw switch has two switches and each switch has two tongue rails placed side by side. There is a combined heel block for both the tongue rails of the switch. The switches can be operated in such a way that movement is possible in three different directions, that is, straight, to the right, and to the left. Three-throw switches are

obsolete now as they may prove to be hazardous, particularly at higher speeds, because the use of double switches may lead to derailments.

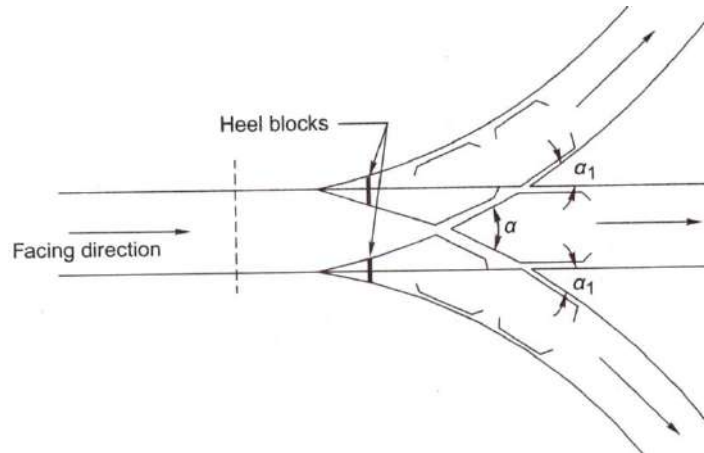

Fig Three-throw switch (contrary flexure)

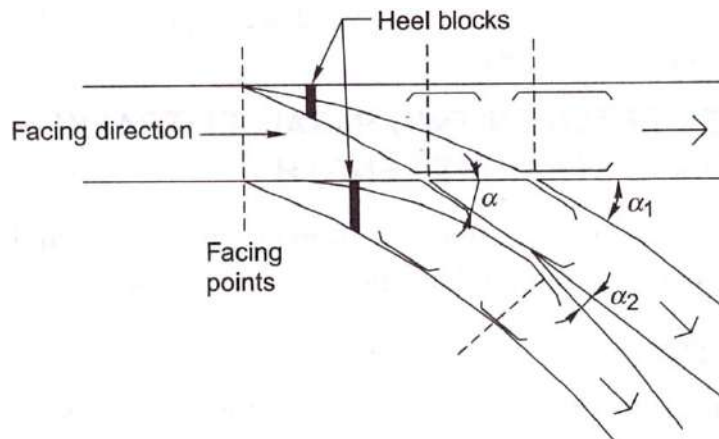

Fig. Three-throw switch (similar flexure)

DOUBLE TURNOUT

A double turnout or *tandem* is an improvement over a three-throw switch. In a double turnout, turnouts are staggered and take off from the main line at two different places. This eliminates the defects of a three-throw switch, as the heels of the two switches are kept at a certain distance from each other. The distance between the two sets of switches should be adequate to allow room for the usual throw of the point.

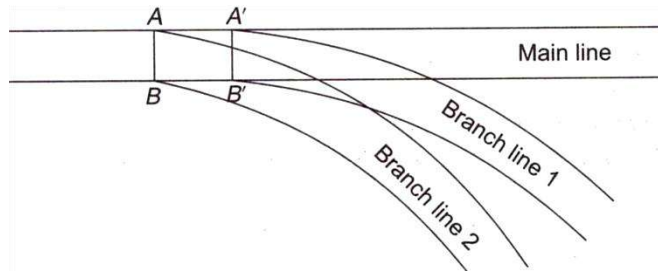

Fig. Double turnout with similar flexure

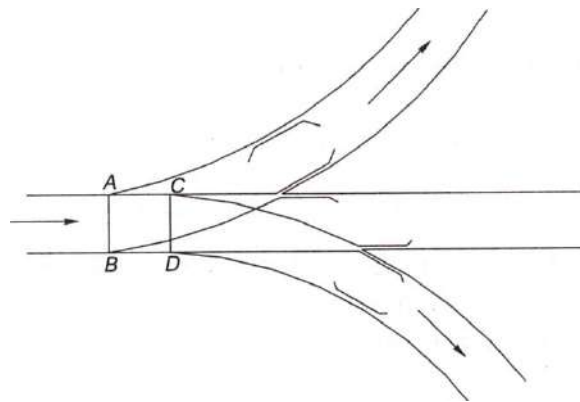

Fig. Double turnout with contrary flexure

Double turnouts are mostly used in congested areas, particularly where traffic is heavy, so as to economize on space.

DIAMOND CROSSING

A diamond crossing is provided when two tracks of either the same gauge or of different gauges cross each other. It consists of two acute crossings (A and C) and two obtuse crossings (B and D).

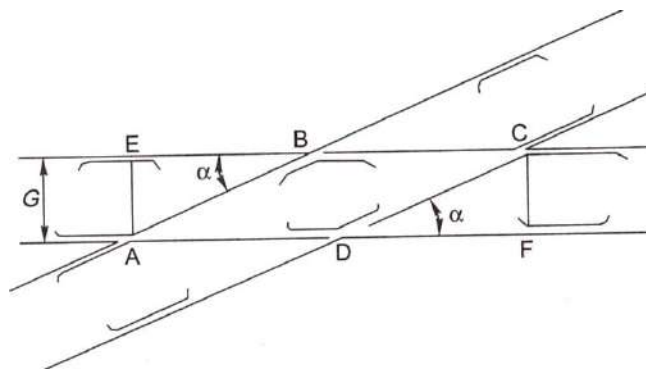

Fig. Diamond crossing

Single Slip and Double Slip

In a diamond crossing, the tracks cross each other, but the trains from either track cannot change track. Slips are provided to allow vehicles to change track.

The slip arrangement can be either single slip or double slip. In single slips, there are two sets of joints, the vehicle from only one direction can change tracks. In the single slip shown in Fig. 15.10, the train on track A can change to track D, whereas the train on track C remains on the same track, continuing onto track D.

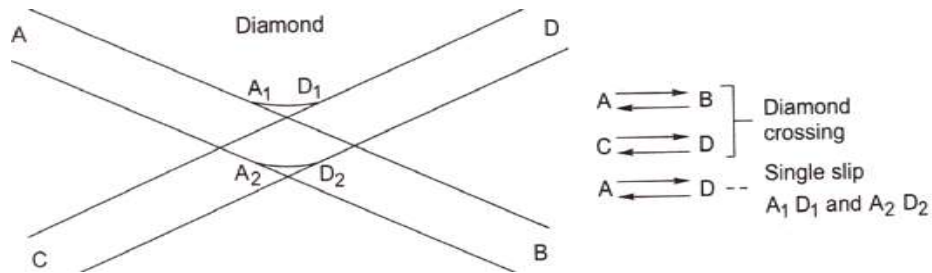

Fig. Single slip

In the case of double slips, there are four sets of points, and trains from both directions can change tracks. In the double slip shown in Fig. the trains on both tracks A and C can move onto either track B or D.

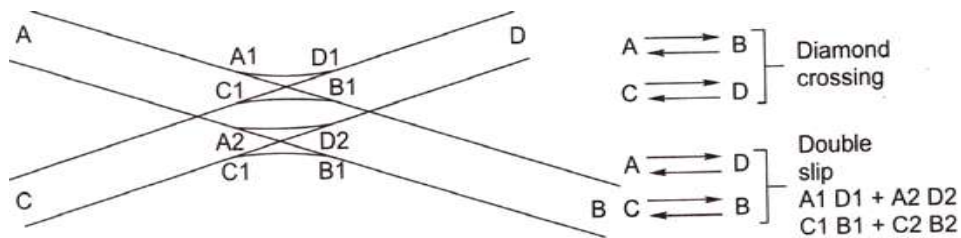

Fig. Double slip

SCISSORS CROSSOVER

A scissors crossover enables transferring a vehicle from one track to another track and vice versa. It is provided where lack of space does not permit the provision of two separate crossovers. It consists of four pairs of switches, six acute crossings, two obtuse crossings, check rails, etc.

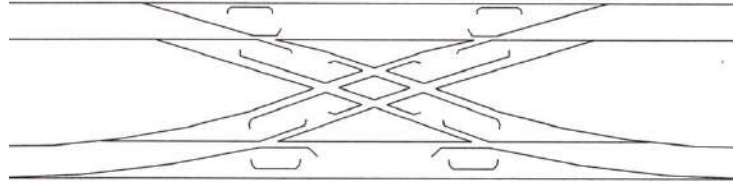

Fig. Scissors crossover

GAUNTLETTED TRACK

Gauntletted track is a temporary diversion provided on a double-line track to allow one of the tracks to shift and pass through the other track. Both the tracks run together on the same sleepers. It proves to be a useful connection when one side of a bridge on a double-line section is required to be blocked for major repairs or rebuilding. The speciality of this layout is that there are two crossings at the ends and no switches [(a)].

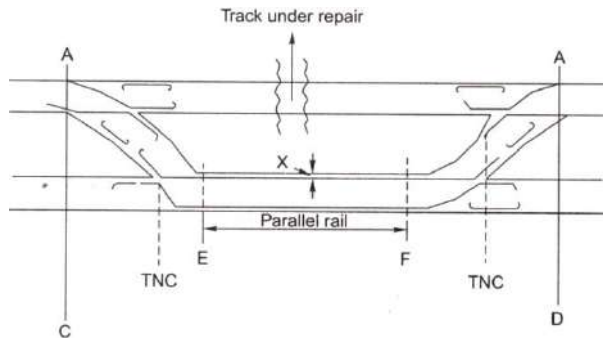

Fig. (a) Gauntletted track

Gauntletted tracks are also used on sections where trains have to operate on mixed gauges, say, both BG and MG, for short stretches. In such cases, both the tracks are laid on the same set of wooden sleepers [(b)].

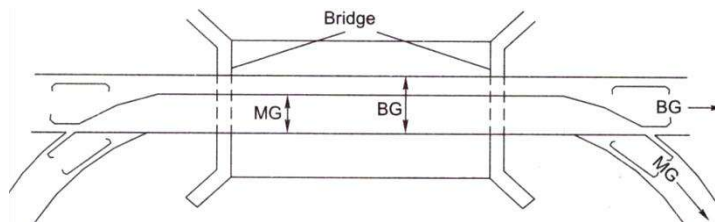
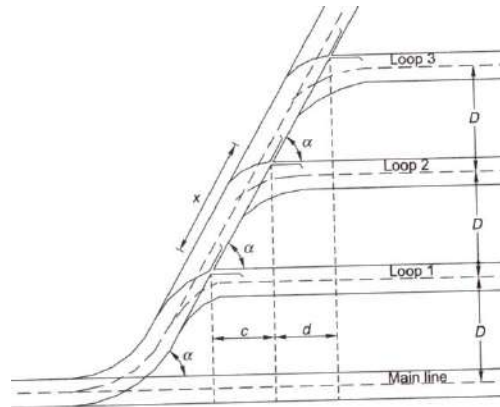
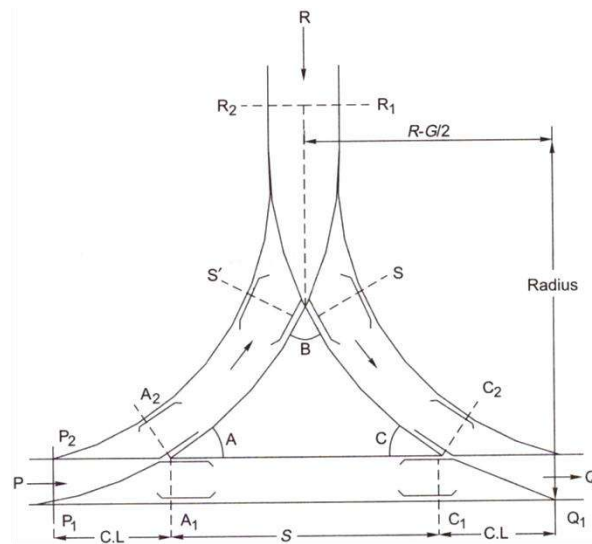

Fig. (b) Gauntletted track for mixed gauge

GATHERING LINE



TRIANGLE



DOUBLE JUNCTIONS

A double junction (Fig. below) is required when two or more main line tracks are running and other tracks are branching off from these main line tracks in the same direction. The layout of a double junction consists of ordinary turnouts with one or more diamond crossings depending upon the number of parallel tracks.

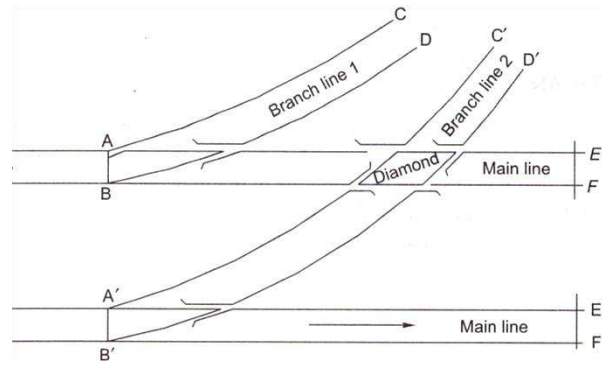

Fig. Double junction

Double junctions may occur either on straight or curved main lines and the branch lines may also be either single or double lines. These types of junctions are quite common in congested yards.

Lecture-26

SIGNAL-I

Introduction

In the early days of railway operation, there was seldom need for more than one train to operate on a section of track at any given time. As traffic increased, it became necessary to operate trains in both directions over single track. The purpose of signalling and interlocking is primarily to control and regulate the movement of trains safely and efficiently. Signalling includes operations and interlocking of signals, points, block instruments, and other allied equipment in a predetermined manner for the safe and efficient running of trains. Signalling enables the movement of trains to be controlled in such a way that the existing tracks are utilized to the maximum.

In fact, in railway terminology signalling is a medium of communication between the station master or the controller sitting in a remote place in the office and the loco pilot (As per latest instructions of the Railway Board, 'drivers' are now called 'Loco Pilots') of the train.

OBJECTIVES OF SIGNALLING

The objectives of signalling are as follows:

To regulate the movement of trains so that they run safely at maximum permissible speeds

To maintain a safe distance between trains those are running on the same line in the same direction

To ensure the safety of two or more trains that has to cross or approach each other

To provide facilities for safe and efficient shunting

To regulate the arrival and departure of trains from the station yard

To ensure the safety of the train at level crossings when the train is required to cross the path of road vehicles

CLASSIFICATION OF SIGNALS

Railway signals can be classified based on different characteristics as presented in Table below.

Table: Classification of signals based on different characteristics

| <i>Characteristics</i> | <i>Basis of classification</i> | <i>Examples</i> |
|-------------------------|--|---|
| Operational | Communication of message in visual form | Fixed signals |
| Functional | Signaling the loco pilot to stop, move cautiously, proceed, or carry out shunting operations | Stop signals, permissive Signals, shunt signals |
| Locational | Reception or departure signals | Reception: Outer, home, Departure: Starter, and advanced starter signals |
| Constructional | Semaphore or colour light signals | Semaphore: Lower quadrant or upper quadrant. Colour light: Two aspects or multiple aspects. |
| Special characteristics | Meant for special purposes | Calling-on signals, repeater signals, coaching signals, etc. |

Figure. below shows further classification of signals and Table below lists the signalling requirements of various classes of stations.

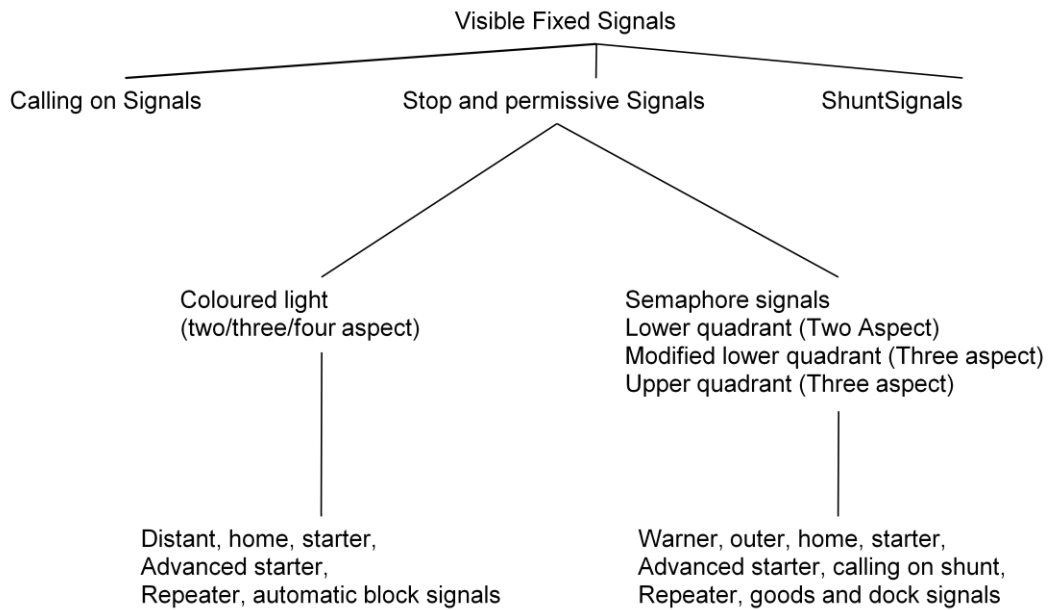

Signals required at stations

| Classification of station | Minimum requirement of signals | Remarks |
|---------------------------|--------------------------------|---|
| A class | Warner, home, and starter | An outer signal can be provided after obtaining special permission |
| B class | Outer and home | In multiple-aspect upper quadrant (MAUQ) areas, distant home and outer signals are provided |
| C class | Warner and home | In MAUQ areas, the warner signal is replaced by a distant signal |

FIXED SIGNALS

The various types of fixed signals used on railways are as follows.

Semaphore signals

The word 'semaphore' was first used by a Greek historian. 'Sema' means sign and 'phor' means to bear. A semaphore signal consists of a movable arm pivoted on a vertical post through a horizontal pin as shown in Fig. below.

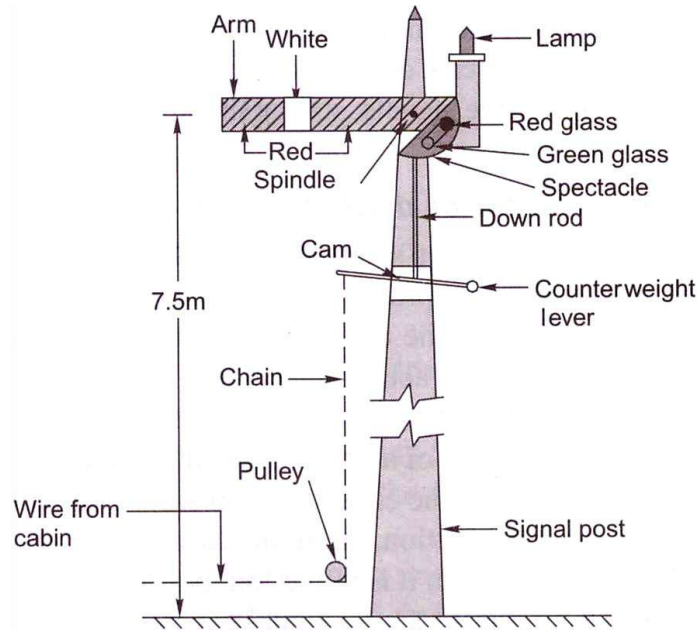

Fig. Semaphore signal

Lower quadrant semaphore signals move only in the fourth quadrant of a circle and have only two colour aspects. In order to provide the drivers with further information, multi-aspect upper quadrant signalling (MAUQ) is sometimes used on busy routes. In this system, the arms of the semaphore signals rest in three positions and the signals have three colour aspects, namely red, yellow, and green associated with the horizontal, 45° above horizontal and vertical directions, respectively. Details of MAUQ are given in subsequent paras.

Stop signal in MAUQ, Signaling

In case of multi-aspect upper quadrant (MAUQ) signaling of semaphore stop signal with a square ended arm, there may be three situations (Figure below) as indicated below in Table below:

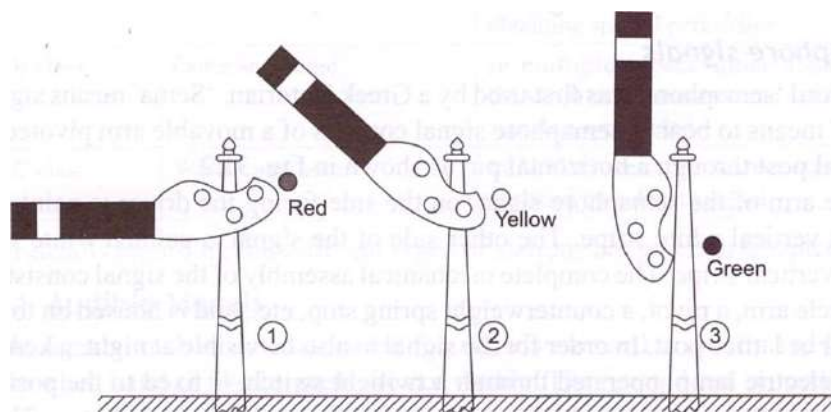

Fig. Semaphore stop signal in MAUQ signaling

Table Aspects and indications of stop signal in MAUQ signaling

| Position | Aspect of signal | Position of arm | Colour during night | Indication |
|-----------------|-------------------------|-------------------------|----------------------------|---|
| 1. | ON-Stop | Horizontal | Red | Stop dead |
| 2. | OFF-Caution | 45° above Horizontal | Yellow | Proceed with caution and be prepared to stop at next signal |
| 3. | OFF-Proceed | 90° above Horizontal | Green | Proceed at maximum permitted speed |

The signals are designed to be fail-safe so that if there is any failure in the working of the equipment, they will always be in the stop position. These signals are operated by hand levers or buttons located in a central cabin, which is normally provided near the station master's office. Semaphore stop signals are normally provided as outer signals, home signals, starter signals, advanced starter signals, and warner signals.

Permissive signal—warner or distant signal

In order to ensure that trains speed up safely, it is considered necessary that warning be given to drivers before they approach a stop signal. This advance warning is considered necessary, otherwise the drivers may confront a 'stop signal' when they least expect it and take abrupt action, which can lead to perilous situations. A warner or distant signal has, therefore, been developed, which is to be used ahead of a stop signal and is in the form of a permissive signal that can be passed even in most restricted conditions. In the case of a stop signal, the driver has to stop the train when it is in the 'on' position, but in the case of a permissive signal, the driver can pass through even when it is in the 'on' position.

Distant signal in MAUQ, signaling

In case of multi-aspect upper quadrant (MAUQ) signaling for semaphore distant signal, there is a fish tailed arm, painted yellow with a black band near the edge of the arm (Fig. below). There are three aspects and indications of the same are presented in Table below.

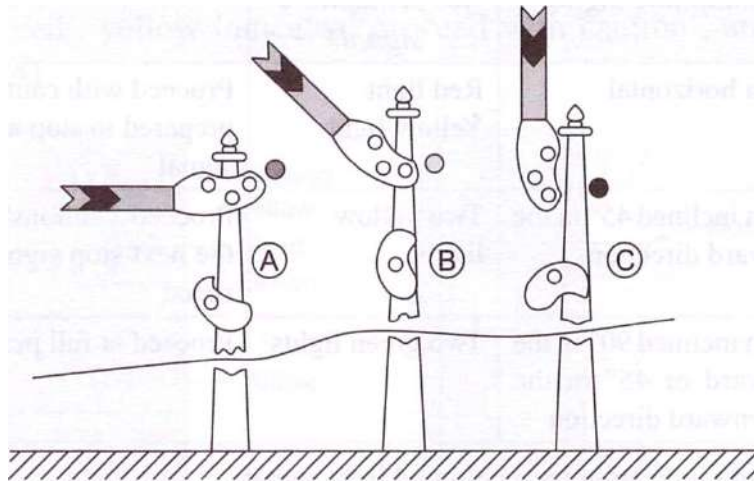

Fig. Semaphore distant signal in MAUQ signaling

Table Aspects and indications of distant semaphore signal in MAUQ signaling

| <i>Case</i> | <i>Aspect of signal</i> | <i>Position of arms</i> | <i>Colour during night</i> | <i>Indications</i> |
|-------------|-------------------------|-------------------------|---|---|
| A | ON — Caution | Horizontal | Yellow light | Proceed and be prepared to stop at next stop signal. |
| B | OFF | 45° above horizontal | Two yellow lights in vertical alignment | Proceed and be prepared to pass the next signal at caution. |
| C | OFF — Proceed | 90° above horizontal | Green light | Proceed at maximum permitted speed. |

In the case of signaling using colored light, the permissive signal is distinguished from the stop signal by the provision of a P marker disc on the signal post.

The warner signal is intended to warn the driver of a train regarding the following aspects as explained in Table below.

- (a) To inform that the driver is approaching a stop signal
- (b) To inform the driver as to whether the approach signal is in 'on' or 'off' position

The warner signal can be placed at either one of the following locations.

- (a) Independently on a post with a fixed green light 1.5 m to 2 m above it for night indication
- (b) On the same post below the outer signal or the home signal

In case a warner is fixed below an outer signal the various positions of the outer and warner signals and their corresponding indications are given in Fig. below.

Table: Position of warner arm or distant signal

| <i>Position</i> | <i>Day indication for semaphore signal</i> | <i>Night indication for semaphore signal*</i> | <i>Aspect</i> |
|-----------------|---|---|---|
| Caution | Arm horizontal | Red light Yellow light | Proceed with caution and be prepared to stop at the next stop signal |
| Attention | Arm inclined 45° in the upward direction | Two yellow lights | Proceed cautiously so as to pass the next stop signal at a restricted speed |
| Proceed | Arm inclined 90° in the upward or 45° in the downward direction | Two green lights | Proceed at full permissible speed |

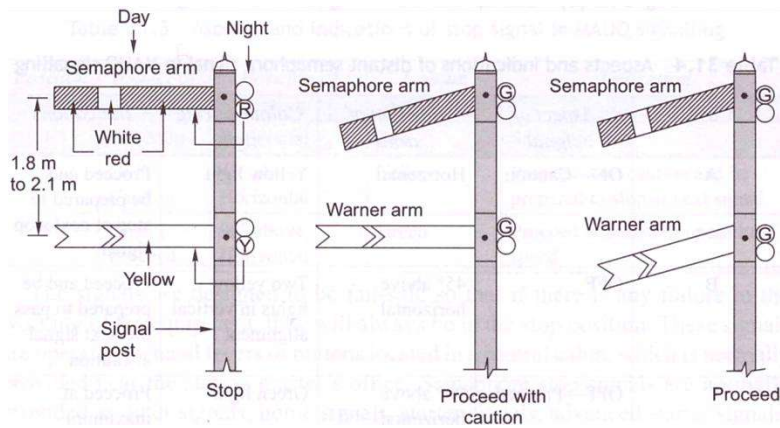

* Under revision

Lecture-27

SIGNAL-II

STOP SIGNALS

The various types of stop signals with reference to their location on a station are discussed here in detail.

Outer signal on double-line section

This is the first semaphore stop signal at a station that indicates the entry of a train from a block section into the station limits. This signal is provided at an adequate distance beyond the station limits so that the line is not obstructed once the permission to approach has been given. It is provided at a distance of about 400 m from the home signal. The signal has one arm but has a warning signal nearly 2 m below on the same post.

Home signal on double-line section

After the outer signal, the next stop signal towards the station side is a home signal. It is provided right at the entrance of the station for the protection of the station limits. The signal is provided about 50 m short of the points and crossings. The arms provided on a home signal are generally as many as the number of reception lines in the station yard. The signal for the main line is provided on a 'doll', which is higher than others.

Routing signal

The various signals fixed on the same vertical post for both main and branch lines are known as routing signals. These signals indicate the route that has been earmarked for the reception of the train. Generally, the signal for the main line is kept at a higher level than that for the loop line. It is necessary for the driver of a train approaching a reception signal to know the line on which his or her train is likely to be received so that he or she can regulate the speed of the train accordingly. In case the train is being received on the loop line, the speed has to be restricted to about 15 km per hour, whereas if the reception is on the main line, a higher speed is permissible.

Signaling arrangement under Modified Lower Quadrant Signaling System

Since lower quadrant semaphore two aspect signaling system is capable of conveying limited information to the loco pilot, the arrangement was modified to be known as Modified Lower

Quadrant Signaling. In this an arrangement a warner is provided on the same doll as that of mainline home signal. see Fig. below.

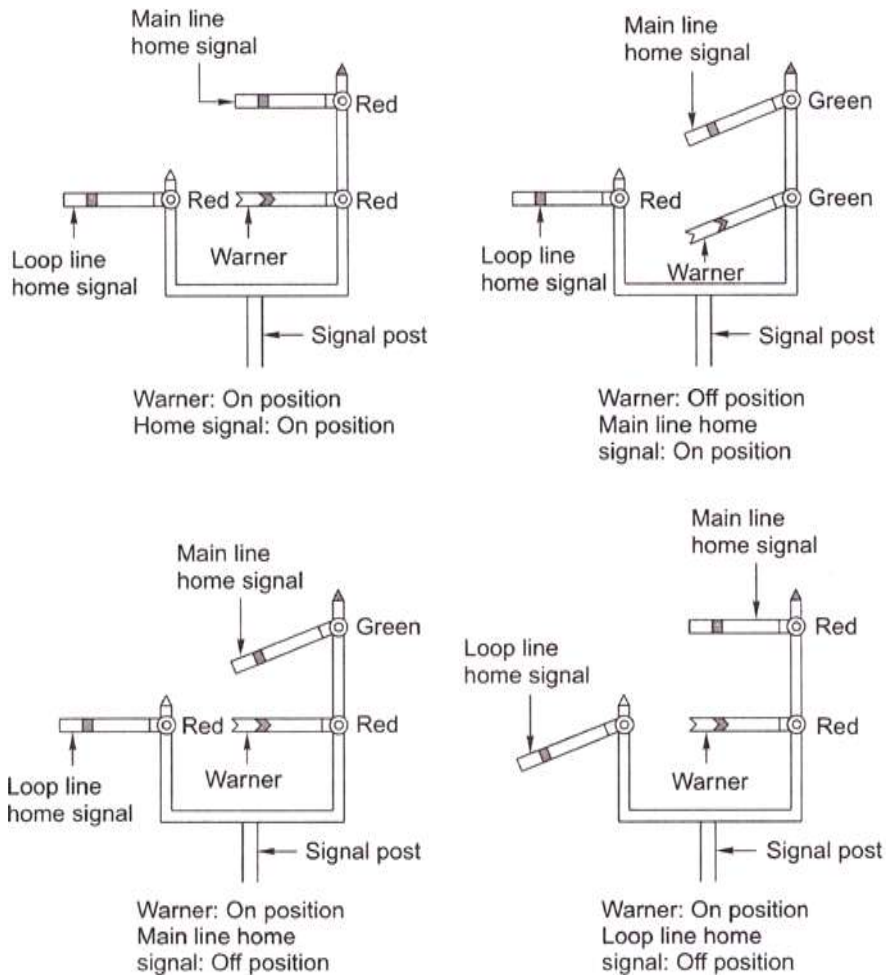

Fig. Modified lower quadrant signaling arrangement

Route indicators can also be provided by including separate home signals for each line, with the main line home signal being placed the highest while all the other signals are placed at the same level.

In the case of coloured light signals, the home signal is provided with either a graphic lighted route indicator displaying the line number on which the train is to be received or different arms lighted by five lamps. These lamps form the arm, which is used for indicating a line, while there is no arm in the case of a main line as depicted in Fig. below.

Starter signal

The starter signal is a stop signal and marks the limit upto which a particular line can be occupied without infringing on other lines. A separate starter signal is provided for each line. The starter signal controls the movement of the train when it departs from the station. The train leaves the station only when the starter signal is in the 'off' position. As this signal controls the departure of a train, it comes under the category of departure signals.

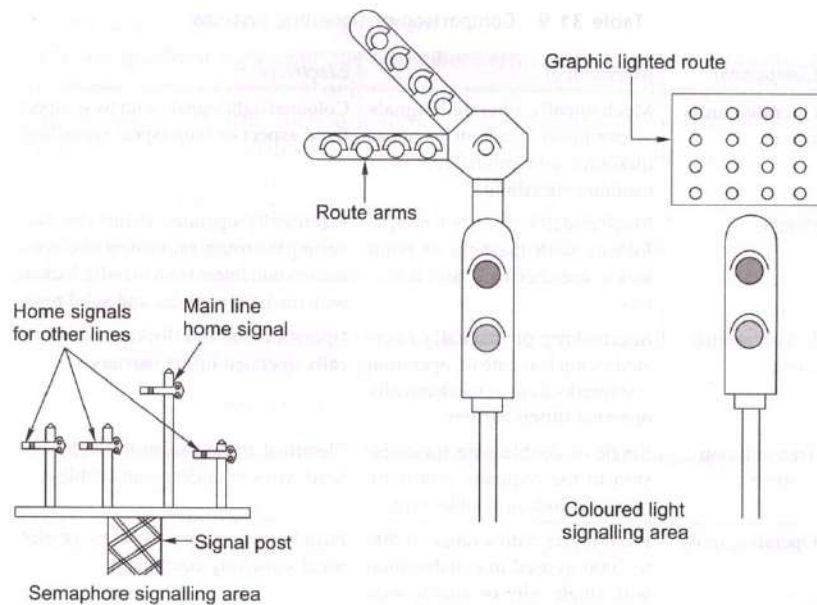

Fig. Route indicators in semaphore and colour light signalling areas

Advanced starter signal

This is the last stop signal provided for the departure of trains from a station. The signal is provided beyond the outermost points or switches and marks the end of the station limits. A block section lies between the advanced starter signal of one station and the outer signal of the next station. No train can leave the station limits until and unless the advance starter is taken off.

SIGNALLING SYSTEMS

The signalling system can be broadly classified into two main categories.

- (a) Mechanical signalling system
- (b) Electrical signalling system

In addition to these two main categories of signalling systems, electronic or solid-state signalling system is also in use. Each system of signalling comprises five main components.

- (a) Operated units such as signals and points
- (b) Interlocking system
- (c) A transmission system such as single- or double-wire transmission or electrical transmission through cables
- (d) Operating units such as levers and press buttons
- (e) Monitoring units such as detectors, treadle bars, and track circuits

The comparison between mechanical and electrical signalling based on these five broad components is given in Table below.

Table : Comparison of signalling systems

| <i>Component</i> | <i>Mechanical</i> | <i>Electrical</i> |
|------------------------|--|--|
| Operated units signals | Mechanically operated signals as per lower quadrant or upper quadrant and modified lower quadrant signalling | Coloured light signals with two- aspect, three-aspect or four-aspect signalling |
| Points | Mechanically operated points; locking with the help of point locks, stretcher bars, and detectors | Electrically operated points (by converting the rotary movement of electric motors into linear push or pull); locking with the help of slides and solid rods |
| Level crossing gates | Interlocking of manually operated swing leaf gate or operation and Interlocking of mechanically operated lifting barriers | Operation and Interlocking of electrically operated lifting barriers |
| Transmission systems | Single or double wire transmission to the requisite points by means of rods or double wires | Electrical transmission through overhead wires or underground cables |
| Operating units | Hand levers with a range of 500 to 2000 m used in collaboration with single wire or double wire lever frames | Push buttons, rotary switches, or electrical signalling equipment |
| Interlocking units | Mechanical interlocking with plungers attached with levers and tappets moving across in a locking trough | Interlocking through electromagnetic switches known as relays or solid-state switching devices |
| Monitoring units | Monitoring of points with the help of mechanical detectors; monitoring of the passage of trains using a treadle, which is an electro-mechanical device | Monitoring with the help of direct current track circuits, alternating current track circuits, electronic track circuits, axle counters, etc. |

MECHANICAL SIGNALLING SYSTEM

The mechanical signalling system mostly involves signals and points as explained in this section. In this system, both the signalling system and the interlocking are managed mechanically.

Signals

The signals used in a mechanical signalling system are semaphore signals. These signals are operated by means of either a lower quadrant or an upper quadrant signalling system.

Lower quadrant signalling system

This system of signalling was designed so that the semaphore arm of the signal could be kept either horizontal or lowered. The lower left-hand quadrant of a circle is used for displaying a semaphore indication to the driver of a train. This concept was possibly developed based on the left-hand driving rules applicable on the roads in UK and India.

Upper quadrant signalling system

In lower quadrant signalling, the semaphore arm of the signal can only take two positions, namely horizontal or lower; it is not possible to include a third position for the semaphore arm, such as a vertically downward position due to design as well as visibility problems, since as the semaphore arm would, in that case, be superimposed on the signal post. Due to this limitation, the upper quadrant system (see Table 31.10) was developed, which can display more than two aspects. In this system, it is possible to incorporate three positions of the semaphore arm, namely (a) horizontal, (b) inclined at an angle of about 45° above the horizontal level, and (c) vertical, i.e., inclined at an angle of 90° above the horizontal level, see Fig. below. The positions of the arm, the corresponding indications, and their meanings are listed in Table below.

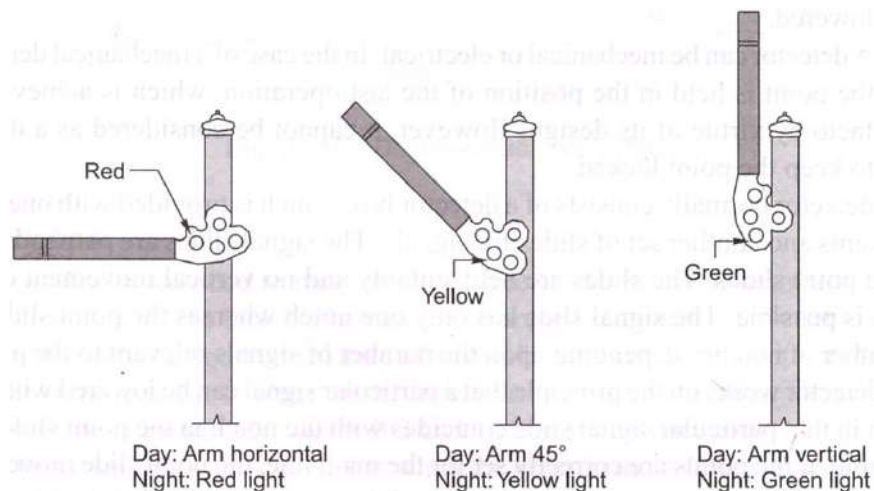

Fig. Upper Quadrant signalling

Lecture-28

SIGNAL-III

COLOURED LIGHT SIGNALS

These signals use coloured lights to indicate track conditions to the driver both during the day and the night. In order to ensure good visibility of these light signals, particularly during daytime, the light emission of an electric 12 V, 33 W lamp is passed through a combination of lenses in such a way that a parallel beam of focused light is emitted out. This light is protected by special lenses and hoods and can be distinctly seen even in the brightest sunlight. The lights are fixed on a vertical post in such a way that they are in line with the driver's eye level. The system of interlocking is so arranged that only one aspect is displayed at a time. Coloured light signals are normally used in automatic signalling sections, suburban sections, and sections with a high traffic density

Coloured light signals can be of the following types.

- (a) Two-aspect, namely green and red
- (b) Three-aspect, namely green, yellow, and red
- (c) Four-aspect, namely green, double yellow, and red

In India, mostly three-aspect or four-aspect coloured light signalling is used. In the case of three-aspect signalling, green, yellow, and red lights are used. Green indicates 'proceed', yellow indicates 'proceed with caution', and red indicates 'stop'(Fig. below).

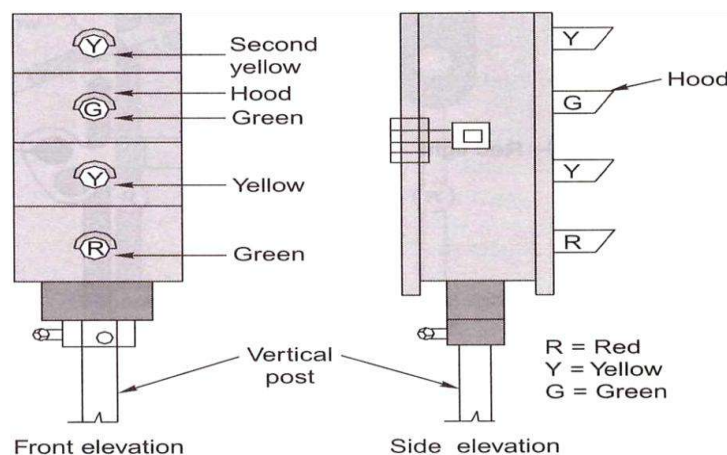

Fig. Colored light signals

In the case of four-aspect colored light signaling, the interpretations of the colours are given in Table below.

Table : Indications of colored light signals

| Colour of signal | Interpretation |
|-------------------|---|
| Red | Stop dead |
| Yellow | Pass the signal cautiously and be prepared to stop at the next signal |
| Two yellow lights | Pass the signal at full speed but be prepared to pass the next displayed together signal, which is likely to be yellow, at a cautious speed |
| Green | Pass the signal at full permissive speed |

In conventional semaphore signals, the 'on' position is the normal position of the signal and the signals are lowered to the 'off' position only when a train is due. In the case of coloured light signals placed in territories with automatic signalling, the signal is a\way green or in the 'proceed' position. As soon as a train enters a section, the signal changes to 'red' or the 'stop' position, which is controlled automatically by the passage of the train itself. As the train passes through the block section, the signal turns yellow to indicate the driver to 'proceed with caution' and, finally, when the train moves onto the next block section, the signal turns green indicating to the driver to 'proceed at full permissible speed'.

Thus, it can be seen that each aspect of the signal gives two pieces of information to the driver. The first is about the signal itself and the second is about the condition of the track ahead or of the next signal. This helps the driver to manoeuvre the train safely and with confidence even at the maximum permissible speed.

Calling-on signal

This consists of a small arm fixed on a home signal post below the main semaphore arm. When the main home signal is in the horizontal (on) position and the calling-on signal is in an inclined (off) position, it indicates that the train is permitted to proceed cautiously on the line till it comes across the next stop signal. Thus, the calling-on signal is meant to 'call' the train, which is waiting beyond the home signal.

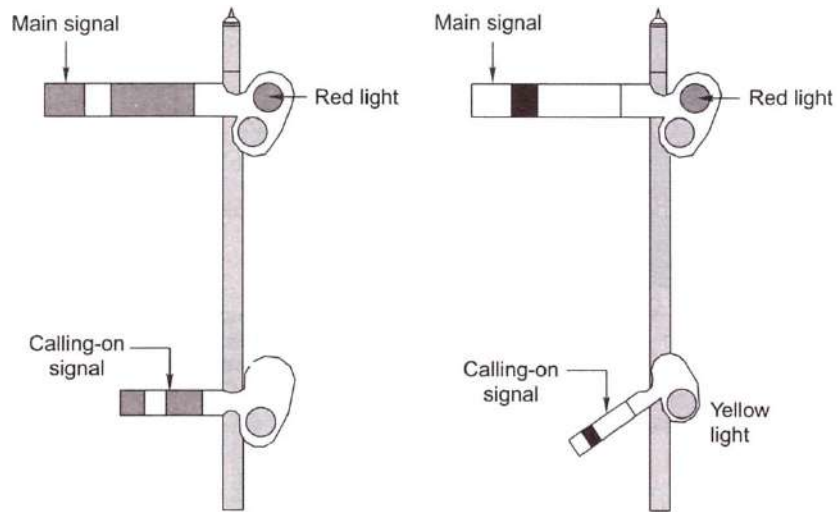

Fig. Calling-on signal

The calling-on signal is useful when the main signal fails, and in order to move a train, an authority letter has to be sent to the driver of the waiting train to instruct him/her to proceed to the station against what is indicated by the signal. In big stations and yards, the stop signals may be situated far off from the cabin and the calling-on signal expedites the quick reception of the train even when the signal is defective.

Co-acting signal

In case a signal is not visible to the driver due to the presence of some obstruction, such as an overbridge or a high structure, another signal is used to move along the main signal on the same post. This signal, known as the co-acting signal, is an exact replica of the original signal and works in unison with it.

Repeater signal

In case where a signal is not visible to the driver from an adequate distance due to sharp curvature or any other reason or where the signal is not visible to the guard of the train from his position at the rear end of a platform, a repeater signal is provided at a suitable position at the rear of the main signal. A repeater signal is provided with an R marker and can be of the following types.

- (a) A square-ended semaphore arm with a yellow background and a black vertical band
- (b) A colored light repeater signal
- (c) A rotary or disc banner type signal

The 'off positions of these three types of repeater signals are depicted in Fig. below.

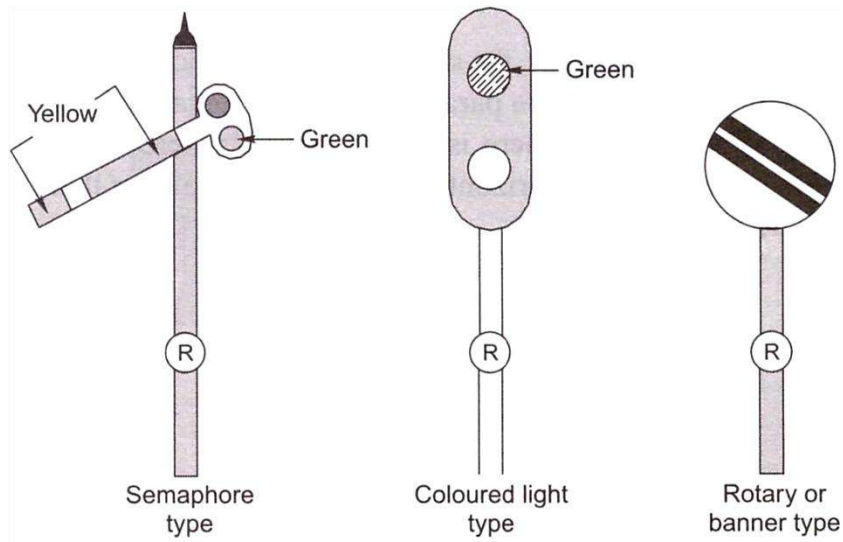

Fig. Different types of repeater signals

Shunt signals

These are dwarf or miniature signals and are mostly used for regulating the shunting of vehicles in station yards. Unlike fixed signals, these are small in size and are placed on an independent post or on a running signal post (Fig. below). In semaphore signaling areas, the shunt signals are of the disc type.

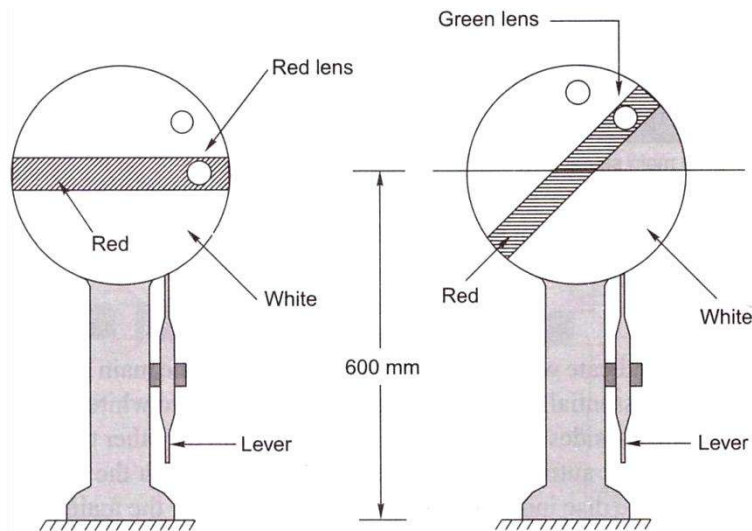
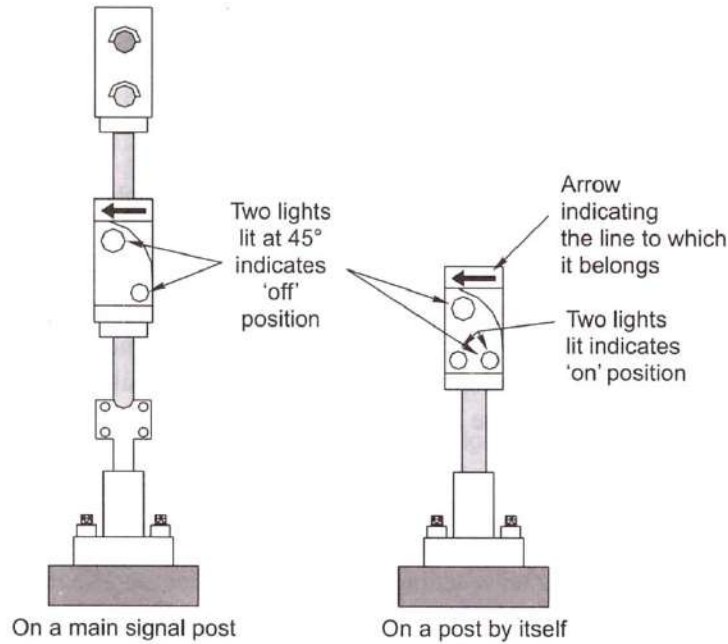

Fig. Disc type shunt signals



Point indicators

These are used to indicate whether points have been set for the main line or turnout side (Fig. below). It essentially consists of an open box with two white circular discs forming two opposite sides of the box and green bands on the other two remaining sides. The box rotates automatically about a vertical axis with the movement of the points. The white disc indicates that the points are set for the main line. When the points are set for the turnout side, the green bands are visible to the loco pilot (driver). At night white light indicates a main line setting and green light signifies a turnout side settings.

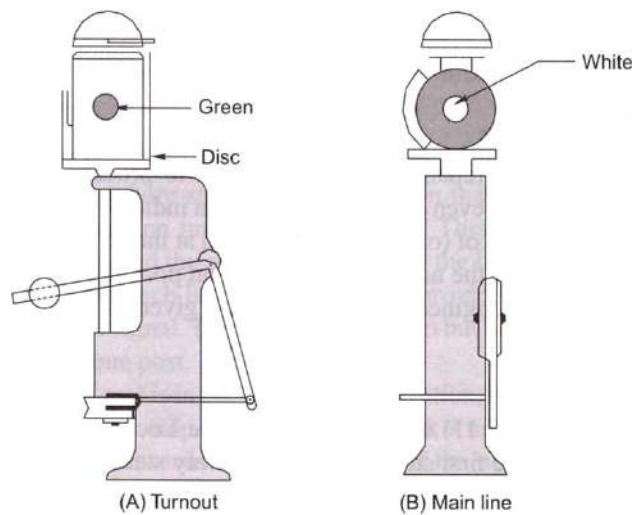

Fig. Point indicators

Trap indicator

A trap is a device fitted on the track, which in its open position derails the vehicle that passes over it. When the trap is closed, the vehicle passes over it as it would over a normal track. A trap indicator reveals whether the trap is in an 'open' or 'closed' position. The details of the same are given in Table below.

Table Operation of a trap indicator

| <i>Position of trap</i> | <i>Day indication</i> | <i>Night indication</i> |
|-------------------------|-----------------------|-------------------------|
| Trap open | Red target | Red light |
| Trap closed | Green target | Green light |

Dock signal This signal leads the train to the dock platform. In this case, the semaphore reception signal is provided with a stencil-cut letter 'D' on the signal for use. Figure (a) below shows the 'on' position of the dock signal.

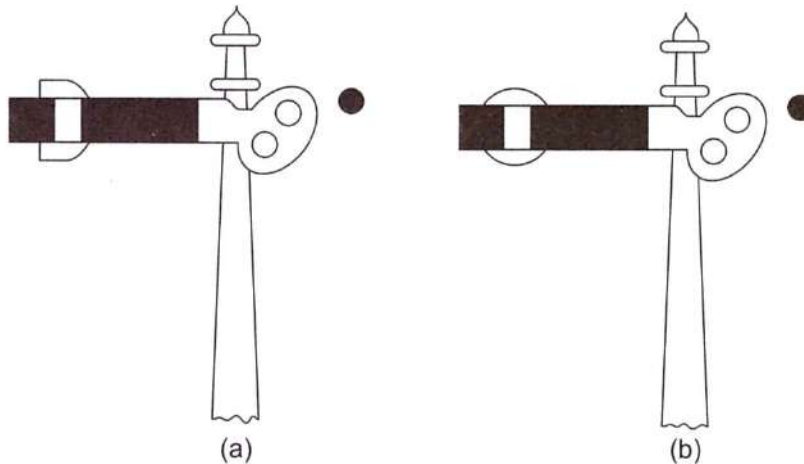

Fig. (a) Dock signal (on position) and (b) Goods signal (on position)

Goods signal This signal leads the train to the goods running line. In this case a stencil-cut letter 'O' is provided on the signal arm of a semaphore signal as shown in Fig. (b) above.

Engineering indicators

When the track is under repair, trains are required to proceed with caution at restricted speeds and may even have to stop. Caution indicators help the driver of a train to reduce the speed of (or even stop) the train at the affected portion of the track and then return it to the normal speed once that portion has been covered.

Sighting board

A sighting board (Fig. below) is an indication to the Loco pilot (driver) that he or she is approaching the first stop signal of a railway station. The function of a sighting board is to allow the driver to estimate the location of the next stop signal from the current location so that he/she starts applying brakes in case the first stop signal is in an 'on' position.

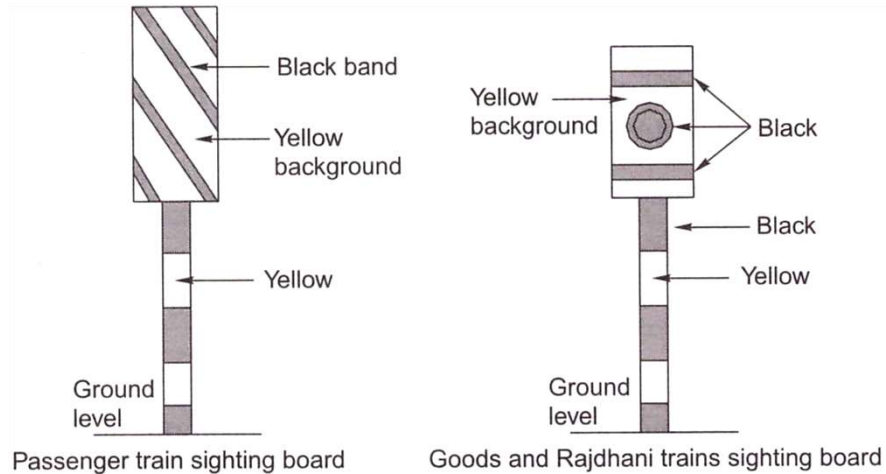

Fig. Sighting board

As the requisite braking distance of goods trains and Rajdhani trains is greater than that of the passenger trains, the sighting boards for goods trains and Rajdhani trains are located farther and their design is different from that of sighting boards meant for passenger trains. The distances of sighting boards are listed in Table below.

Table : Positions of sighting boards

| <i>Type of sighting board</i> | <i>Position</i> |
|--|--|
| Passenger train sighting board | 1000 m for speeds over 72 kmph for BG tracks and 48 kmph for MG tracks |
| Goods trains and Rajdhani sighting board | 1400 m for speeds over 72 kmph for BG tracks and 48 kmph for MG tracks |

Lecture-29

PRINCIPLES OF INTERLOCKING-I

Points

Points are set mechanically and are kept in locks and stretcher bars. The mechanical arrangement for operating them includes a solid rod with a diameter of 33 mm running from the lever provided in the cabin and connected to the point through cranks and compensators. Owing to transmission losses, the operating points with rods is restricted to a specified distance from the cabin.

The following devices are used to ensure that the points are held rigidly in the last operated position under a moving train and to ensure absolute integrity of the same.

- (a) Point locks to hold the point in the required position and to rigidly hold the point in the position of the last operation
- (b) Facing point lock with lock bars to prevent the movement of points when a train is passing over them

Point locks

A point lock is provided to ensure that each point is set correctly. It is provided between two tongue rails and near the toe of the switch assembly. The point lock consists of a plunger, which moves in a plunger casing of facing point lock. The plunger is worked by means of a plunger rod, which is connected to the signal cabin through a lock bar. Additionally, there is a set of stretcher blades and each blade is connected to one of the tongue rails. Each blade has two notches and they move inside the facing point lock plunger casing along with the tongue rails. When the points are set correctly for a particular route, the notch in the stretcher blade rests in its proper position and the plunger rod enters the notch, locking the switch in the last operated position.

Detectors

Detectors are normally provided for all the points for the following reasons.

- (a) To detect any defect or failure in the connection between the points and the lever as well as any obstruction between the stock and the tongue rail.
- (b) To ensure that the correct signal, which corresponds to the point set, is lowered.

(c) A detector can be mechanical or electrical. In the case of a mechanical detector, the point is held in the position of the last operation, which is achieved de facto by virtue of its design. However, it cannot be considered as a device to keep the point locked.

A detector normally consists of a detector box, which is provided with one slide for points and another set of slides for signals. The signal slides are perpendicular to the point slides. The slides are held suitably and no vertical movement of the same is possible. The signal slide has only one notch whereas the point slide has a number of notches depending upon the number of signals relevant to the points. The detector works on the principle that a particular signal can be lowered when the notch in that particular signal slide coincides with the notch in the point slide. For example, if the points are correctly set for the main line, the point slide moves and its notch comes to rest opposite the notch of the main line signal slide. The main line signal slide can then be pulled and the main line signal lowered. It may be noted here that the point slide will move and its notch will rest in its correct position only if the points are properly set and there is no obstruction in between.

The linear type (or slide type) of mechanical detector is used for single-wire signalling (Fig. a below), whereas the rotary type of detector (Fig. b below) is used for the double-wire signalling. A double-wheel detector is a rotary-type detector that rotates in a vertical plane. It detects the correct setting of points and, in addition, locks the points in the last operated position in the case of wire breakage.

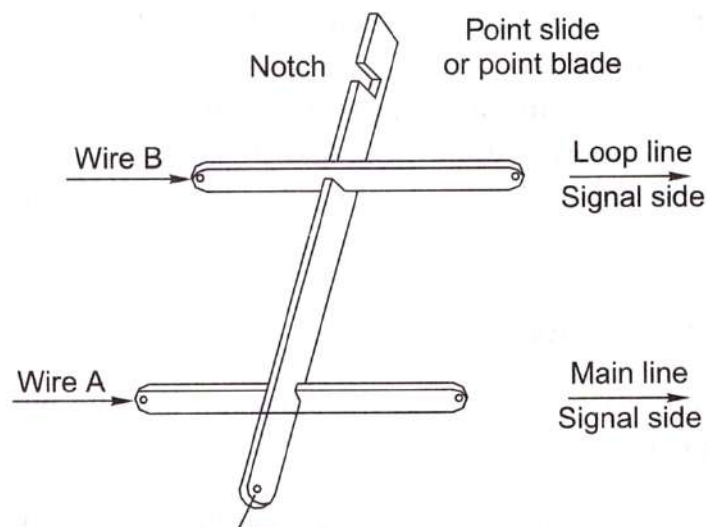

Fig. a Mechanical detector for single-wire signalling

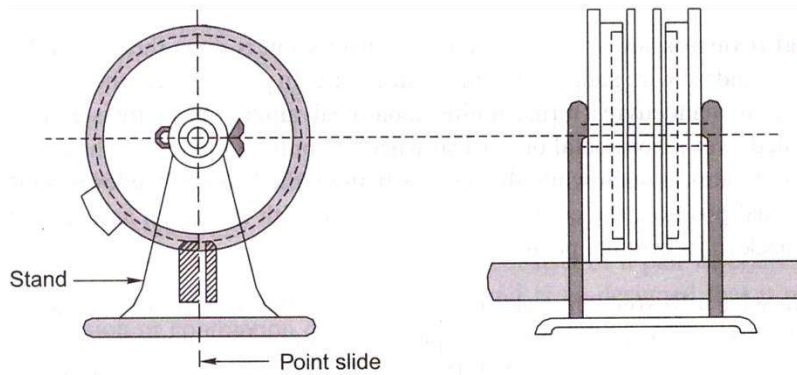

Fig. b Double-wheel rotary detector

Lock bar

A lock bar is provided to make it impossible to change the point when a train is passing over it. The lock bar is made of an angled section and its length is greater than that of the longest wheel base of a vehicle. Short revolving clips are provided to hold the lock bar in place on the inside face of one of the rails. The length of a lock bar is normally 12.8 m for BG and 12.2 m for MG sections. The system is so designed that when the lever in the cabin is pulled to operate the locking device, the lock bar rises slightly above the rail level and then comes down. In the occurrence that a vehicle is positioned on the same location, the lock bar cannot rise above the rail level due to the flanges of the wheel and as such the point cannot be operated.

Types of Transmission Systems

A signal is operated by pulling the associated lever and this action is transmitted through a single-wire or double-wire system. Initially, the single-wire system was the most popular way of operating signals and, in fact, some stations on Indian railways still use this system. In the single-wire system, only one wire is stretched between the operating lever and the signal, whereas in the double-wire system a loop of two wires that run parallel to each other is wrapped over a drum lever and this system works on the principle of the pull and push arrangement.

- ✓ ***Single-wire transmission***
- ✓ **Lever frame**
- ✓ **Signal transmission wire**
- ✓ **Cabin wire adjuster**
- ✓ **Signal parts and fitting**
- ✓ ***Limitations of single-wire signaling***

Rod transmission In the single-wire transmission system, the signal is lowered or set in the 'off' position by pulling the lever. The signal returns to the 'on' position due to the effect of gravity as soon as the lever is restored to its normal position and the tension in the wire is released.

Where the operation of points is concerned, the points have to be set in either the normal or the reverse position; one of these positions can be attained through pulling and the other by pushing. Solid rods of 30 mm (1 1/4 ") diameter are used to connect the levers to the points. The rods or pipes move on standard roller guides fixed at about 2 m (6 ft) intervals. A suitable crank is also used at every change of direction. The rods are subjected to expansion and contraction due to temperature variations and as such are provided with rod compensators at designed intervals.

Rod temperature compensator

A rod compensator, also known as a temperature compensator, is provided to neutralize the effect of thermal variations. It consists of a pair of cranks—one acute and one obtuse—connected by a link and is so designed that it absorbs the expansion or contraction due to temperature variations. The compensator is normally placed at the centre of the rod upto a length of 36.5m. If more than one compensator is required, these are placed at quarter points.

As can be seen in Fig. below, the points, A or B may move left or right, but the total distance between them remains the same.

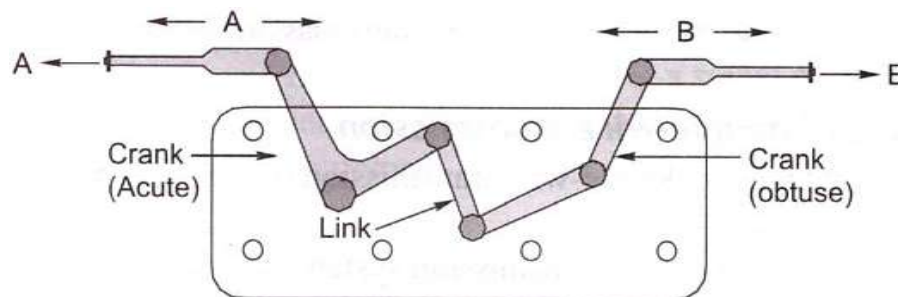

Fig. Temperature compensator

Double-wire transmission system

In this system, power is transmitted with the help of two wires from the lever to operated units, such as signals, points, locks, detectors, and so on. Each wire consists of eight to ten SWG solid galvanized steel wires attached to pulley stakes, which are driven firmly into the ground. The two wires are connected between the lever and the signal to form a continuous loop. When the

lever is operated, it leads to the wire getting pulled and when the lever is brought back to its normal position, it results in a push to the wire. This pull and push mechanism (Fig. a below) causes the drum to rotate in one direction when the lever is pulled and in the other direction when it is restored to its normal position. The rotary motion of the drum is then converted into linear movement by the use of cams and cranks and this finally actuates the signal. Figure b below shows the complete double-wire transmission system.

It may be brought out that double-wire compensators are provided in the wire run to always keep the same tension in the wire.

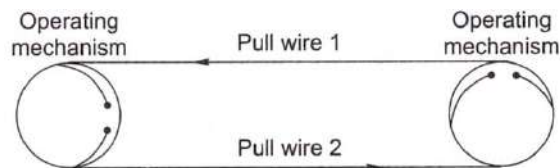

Fig: a Double wire mechanism

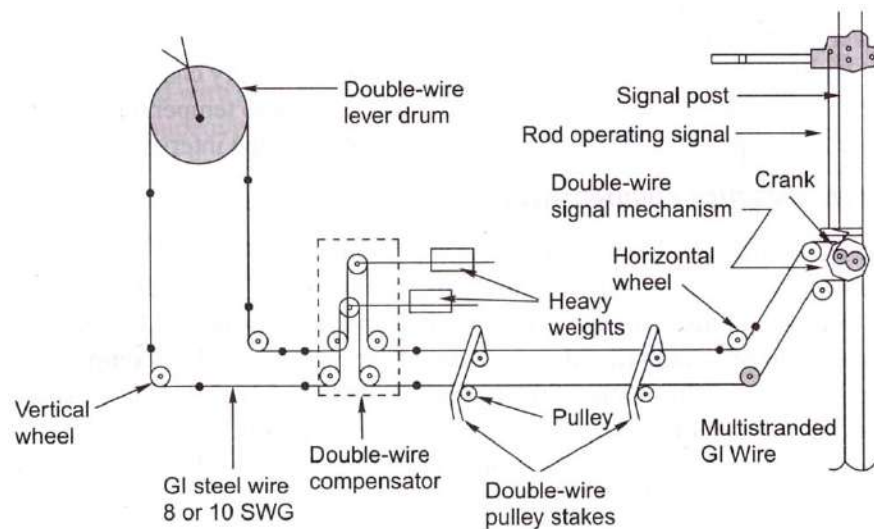

Fig: b Double wire Transmission system

Table below compares a signal-wire and a double-wire signalling system. The special features of a double-wire signalling system are as follows.

ELECTRICAL SIGNALLING SYSTEM

The electrical signalling system is progressively replacing the mechanical signalling system on Indian Railways, especially with the coming up of railway electrification projects facilitating availability of electric power reading. The main reasons behind this are as follows.

- (a) There are a number of movable parts in the mechanical signalling system, such as rods, wires, and cranks, which cause heavy wear and tear, frictional losses, and many of these parts can be sabotaged by unauthorized persons.
- (b) The arms of the semaphore signals used in mechanical signalling afford poor visibility during the day. The night indications of these signals are also not satisfactory.
- (c) The operational time of the mechanical signalling system is much greater than that of the electrical signalling system.

In the electrical signalling system, electrical energy is used for displaying signal aspects. The transmission of power is done electrically and the units are operated by electrical push buttons while the system is monitored by electrical systems. The interlocking in this system is also done electrically.

In the case of electronic or solid state signalling system, the signals are operated by the electrical method, but the interlocking is done electronically.

System of electronic interlocking For electronically managed interlocking system a computer and mouse is used for controlling the signalling system; however, a panel is also used with a switch to change the mode of control from a panel to a visual display unit (VDU).

As control of the signalling system is carried out by a VDU and a mouse, the portion of the signal and interlocking plan shall be selected for taking off the concerned signal by clicking on to the signal profile on the VDU. The system shall work within, following the same principles as in case of electrically interlocked system but analyse the requirements electronically and energize the relays in the form of the final command to operate points and make the concerned signal off.

Operated Units

The operated units consist of signals and points. The electrical signalling system consists of either coloured light signals or signals with semaphore arms operated by electric motors.

A point is operated by converting the rotary movement of the electrical point machines fastened on the sleepers near the point into a linear push or pull force. There are low-voltage point machines operated with a 24 V dc supply and high-voltage point machines operated using a 110

V dc supply. The operation of a point machine involves first unlocking the lock, bringing the point from normal to reverse or reverse to normal as the case may be, and then locking the point once again. The operating time of these point machines varies between three and five seconds.

Transmission Medium

The medium of transmission for operating electrical equipment is either an overhead alignment or an underground copper cable. The overhead alignment is used when the number of conductors is limited. In areas provided with 25 kV ac traction, it is not possible to use overhead alignments due to the induced electromotive force (EMF) generated as a result of electrostatic and electromagnetic induction. In big yards, cables are used as a medium of transmission for the operation of point machines. The cables are either hung on hooks and run by the side of the track or laid underground. In areas provided with ac traction, underground screened cables are used.

Operating System

Normally push buttons and rotary switches are used for operating signalling equipment that work on electricity. The complete yard layout is represented on the face of a console. Signals, tracks, points, and the gates of level crossings are depicted in their geographical positions on this console and the positions of these switches are then marked at the foot of signals and on various tracks.

Complete interlocking is achieved through electromagnetic switches known as *relays*. The two methods of interlocking available are panel interlocking or route relay interlocking.

Pressing of two buttons on the operating console checks clearance of route; if found clear, sets the route by operating points automatically by the system and then locks the route, takes the concerned signal off. This is known as route relay interlocking, often called on smaller stations as 'panel interlocking' as a misnomer.

Monitoring System

A monitoring system mainly consists of point detectors, track circuits, and axle counters, all of which are discussed here in detail.

Electrical point detector

The electrical point detector detects and ensures that points are properly set. It also works on a 'slide system' as used in the mechanical system. These slides are so adjusted that a gap of 3 mm is left between the switch rail and the stock rail so that the two do not come in contact and, therefore, it is not possible to turn the signal off at any time.

Track circuit

The track circuit is an electric circuit formed along with the running rails and connected to the signal and cabin. Its function is to indicate the presence of a train (or vehicle) on the track. In order to set up a track circuit, the ends of the rails forming the circuit are isolated by insulating the rail joints.

The various types of track circuits used on the Railways are as follows.

- (a) Direct current track circuit
- (b) Alternating current track circuit
- (c) Electronic track circuit, which are audio-frequency track circuits

Axle counters

As already mentioned, two consecutive rails need to be insulated from each other for setting up a track circuit. A pair of rail inductors are installed at either end of the track for counting the axles. As soon as a train enters the track section from one end, the number of axles entering the section are counted automatically. Similarly, when the train leaves the track section at the other end, the axles are counted once again at the other end.

Lecture-30

PRINCIPLES OF INTERLOCKING-II

INTERLOCKING

Interlocking is a device or a system meant to ensure the safety of trains. With the increase in the number of points and the signals and introduction of high speeds, it has become necessary to eliminate human error, which would otherwise lead to massive losses of life and property. The points and signals are set in such a way that the cabin man cannot lower the signal for the reception of a train unless the corresponding points have been set and locked. The signal is thus interlocked with the points in a way that no conflicting movement is possible and the safety of trains is ensured. Interlocking may therefore, be defined as a technique, achieved through mechanical or electrical means by which it is ensured that before a signal is taken 'off, the route which the signal controls is properly set, locked and held till such time the entire route is traversed by the train and at the same time all the signals and points, the operation of which would lead to conflicting movements, are locked against the feasibility of such conflicting movements.

The signal and interlocking system is so designed that the failure of any equipment results in the turning 'on' of the signal, thus ensuring train safety.

Essentials of Interlocking

Lever frames and other types of equipment provided for the operation and control of signals, points, etc., must be so interlocked and arranged as to comply with the following essential regulations:

- (a) It should not be possible to turn a signal off unless all points for the line on which the train is to be received are correctly set, all the facing points are locked, and all interlocked level crossings are closed and inaccessible to road traffic.
- (b) The line should be fully isolated before the signal is turned off, i.e., no loose wagons should be able to enter this line.
- (c) After the signal has been taken off, it should not be possible to make adjustments in the points or locks on the route, including those in the isolated line. Also, no interlocked gates should, be released until the signal is replaced to the 'on' position

(d) It should not be possible to turn any two signals off at the same time, which can lead to conflicting movements of the trains.

(e) Wherever feasible, the points should be so interlocked as to avoid any conflicting movement.

Standards of Interlocking

The speed of a train depends on a number of factors such as the haulage capacity of the locomotive, the fitness of the track, the fitness of the rolling stock, the load of the train, the ruling gradient and standard to which the signalling system is provided.

Signaling arrangements

The signalling equipment, manner of locking points, and operation of signals and points differ in the different standards of interlocking. The types of signalling equipment to be provided at different interlocked stations and other requirements to be met for each of the four categories do differ.

Locking of points

The method of locking of points is the key locking in Standard-I. It is an indirect method of interlocking between signals and points. In Standard-II, a plunger type facing point lock is used. The plunger lock can be operated from the cabin or from the site itself. In standard-III and IV, the points are to be centrally operated and the locking between points and signals is required to be direct.

Isolation of lines

In Standard-I, isolation is optional. In Standards II, III, and IV, the main line must be isolated from all the adjoining lines.

Details of signalling as well as of interlocking for different interlocked stations, viz., Standard I, Standard II, Standard III, and Standard IV are briefly summarized in Table below.

Methods of Interlocking

There are basically two methods of interlocking as explained below.

Key interlocking

Key interlocking is the simplest method of interlocking and still exists on branch lines of small stations on Indian Railways. The method involves the manipulation of keys in one form or the other. This type of interlocking is normally provided with standard interlocking with a speed

limit below 50 km per hour. The simplest arrangement of key interlocking is accomplished in the following manner.

(a) Take the example of a station with a main line and a loop line, the point can be set either for the main line or branch line.

(b) The point has two keys, the first is key A, which can be taken out when the point is set and locked for the main line. Similarly, key B can be taken out when the point is set and locked for the loop line. At any given time either key A or key B can be taken out, depending upon whether the route is set for the main line or the loop line.

(c) The lever frame operating the signals is provided with two levers. The lever concerning the main line signal can be operated only by key A and similarly the loop line signal lever can be operated only by key B.

(d) If the train is to be received on the main line, the points are set and locked for the main line and key A is released. This key is used for interlocking the main line signal lever, thus lowering the signal for the main line. Since key A cannot be used for interlocking and lowering the loop line signal, only the appropriate signal can be taken off. This type of interlocking is called indirect locking.

Mechanical system of interlocking

Almost 70 per cent of railway stations in the country work with the mechanical system of signalling. The interlocking arrangements for mechanical signalling system have to be mechanically oriented. There are two systems of mechanically designed signals: (i) single-wire system and the (ii) double-wire system.

A mechanically structured signal has (i) spectacle with an arm; (ii) signal post, which may be tubular or lattice. Longer posts are chosen to be lattice; and (iii) a counterweight to help pull the wire back to allow the signal to go back to its on/normal position.

Such mechanical structures of signals are: (i) two-aspect semaphore signal and (ii) multiple-aspect semaphore signal.

Mechanical interlocking or interlocking on lever frames is an improved form of interlocking compared to key locking.

Electrical system of interlocking

As the signal displays fixed light illuminated by incandescent lamp or a light emitting diode (LED) signal, the operation of such system may be through mechanically operated levers or by push buttons provided on the yard layout depicted on the top of panel box to be termed as the control cum indication panel. Under the electrical signalling system the colour light signals are used in any case operated by lever, points (i) operated by wrought iron solid 33 mm rod; (ii) operated by electric point machines, or operated by Control cum Indication Panel operating points by an electric point machine with signals being coloured light. The system of operation of electrically operated signals by levers is hybrid and is invariably an interim measure to suit 25 kV ac traction, to be subsequently converted to operation by control-cum-indication panel.

Typical Cases of Interlocking

The following typical cases of interlocking are usually encountered.

Normal locking In this case, pulling one lever locks the other lever in its normal position. Such locking shall be required in situation like the signal lever locking a point lever, when the signal requires the point to be moved for train movement.

Back locking or release locking In this case, when the lever is in its normal position, it also blocks the other lever in its normal position, but when this lever is pulled it releases the other lever, which can then be pulled. Furthermore, once the second lever is also pulled, the first lever gets locked in the 'pulled' position and cannot be returned to its normal position unless the second lever is restored to its normal position.

Both-way locking In this case, once a lever is pulled, it locks the other lever in its current position that is, in the normal or pulled position. Such type of locking is normally required in situations when the lock on point is to lock the point in either position. Here, if the point is to be locked in normal condition, the point lever shall get locked as it is by pulling back the lever.

Special or conditional locking In this case, the pulling of one lever locks the other lever only when certain conditions are fulfilled, say the third lever being in a normal or pulled position as the case may be. Such a locking is normally required when a signal leads to more than one route.

Lecture-31

AIRPORT SCENARIO IN INDIA

Introduction

Since its beginning in the early twentieth century, civil aviation has become one of the most fascinating, important, and complex industries in the world. The civil aviation system, particularly its airports, has come to be the backbone of world transport and a necessity to twenty-first-century trade and commerce. In 2008, the commercial service segment of civil aviation, consisting of more than 900 airlines and 22,000 aircraft, carried more than 2 billion passengers and 85 million tons of cargo on more than 74 million flights to more than 1700 airports in more than 180 countries worldwide. Millions more private, corporate, and charter “general aviation” operations were conducted at thousands of commercial and general aviation airports throughout the world. In many parts of the world, commercial service and general aviation serve as the primary, if not the only method of transportation between communities.

The magnitude of the impact of the commercial air transportation industry on the world economy is tremendous, contributing more than \$2.6 trillion in economic activity, equivalent to 8 percent of the world gross domestic product, and supporting 29 million jobs.

Air transport scenario in India

The first commercial flight in India was made on February 18, 1911 by Henri Piquet, a Frenchman. The flight was planned from Allahabad to Naini junction which is a distance of 7 km (5 miles). Same year Sir George Loyd undertook the organization of air flying between Bombay and Karachi. Air service between these cities were considered as purely temporary and was taken as a government venture.

In 1927 British government established Civil Aviation department and (his organization helped in building up of a number of aerodromes and bringing up of some flying clubs. A regular weekly service commenced between Karachi and Delhi in 1929 under Imperial Airways Service. In 1939 Tata Airways Limited started internal air services between Allahabad, Calcutta and Colombo. Later, Indian Trans-Continental Airways Limited was formed for the foreign flights in 1933.

The second world War helped this country for having large number of technical personnel.

Air Transport Licensing Board came into being in 1946. Tata airlines changed its name as Air India Limited in July 1946 there were about eleven operating units by 1947. The night services

commenced in 1949. For external air services, the Government of India entered in agreement in November 1947, with a newly formed organization, named as Air India International Limited. It inaugurated its first international service to London June 8, 1948 via Cairo and Geneva with a fleet of three

Constellation-749 aircraft. The initial frequency of one flight a week was gradually stepped up to seven Super-Constellation services a week with alternate stops at Paris, Prague, Duesseidorf, Zurich, Geneva, - Rome, Cairo, Beirut and Damascus.

Master Committee 1952 recommended the formation of Civil Aviation Board as a statutory body. Air Transport Corporation Bill was passed on May 14, 1953. Under this bill two corporations were established, one for operating international services and the other for domestic services. The domestic operations were taken over by the Indian Airlines Corporation. Similarly, Air India International Limited was renamed as Air India International Corporation. On August 1, 1953 airlines were nationalised.

In April 1960, Air India celebrated entry into the jet age by starting Boeing 707 services to London and later in May to New York—thus becoming the first Asian carrier to operate over the Atlantic.

In July 1967, the Government of India set up the International Airports Committee under the chairmanship of Mr. J. R. D Tata to advise the Government regarding the improvement which are required in the existing international airports in India in view of the continuous growth of air traffic and the likely introduction of very large subsonic and supersonic aircrafts in near future. The interim report of the committee was submitted to the Government in April, 1968. On January 2, 1971, Indian Airlines inaugurated the daily Boeing 737 service on the Bombay-Calcutta and Delhi-Bombay sectors. The country for domestic flights is divided into four flight information regions with centres at Delhi, Bombay Madras and Calcutta.

International Airport Authority of India (IAAI) was set up in April 1972 for the operation, management, planning and development of the four international airports.

The first commercial flight in India was made on February 18, 1911, when a French pilot Monseigneur Piguet flew airmails from Allahabad to Naini, covering a distance of about 10 km in as many minutes. Tata Services became Tata Airlines and then Air-India and spread its wings as Air-India International. The domestic aviation scene, however, was chaotic. When the American Tenth Air Force in India disposed of its planes at throwaway prices, 11 domestic

airlines sprang up, scrambling for traffic that could sustain only two or three. In 1953, the government nationalized the airlines, merged them, and created Indian Airlines. For the next 25 years JRD Tata remained the chairman of Air-India and a director on the board of Indian Airlines. After JRD left, voracious unions mushroomed, spawned on the pork barrel jobs created by politicians. In 1999, A-I had 700 employees per plane; today it has 474 whereas other airlines have 350.

For many years in India air travel was perceived to be an elitist activity. This view arose from the “Maharajah” syndrome where, due to the prohibitive cost of air travel, the only people who could afford it were the rich and powerful.

In recent years, however, this image of Civil Aviation has undergone a change and aviation is now viewed in a different light - as an essential link not only for international travel and trade but also for providing connectivity to different parts of the country. Aviation is, by its very nature, a critical part of the infrastructure of the country and has important ramifications for the development of tourism and trade, the opening up of inaccessible areas of the country and for providing stimulus to business activity and economic growth.

Until less than a decade ago, all aspects of aviation were firmly controlled by the Government. In the early fifties, all airlines operating in the country were merged into either Indian Airlines or AirIndia and, by virtue of the Air Corporations Act, 1953; this monopoly was perpetuated for the next forty years. The Directorate General of Civil Aviation controlled every aspect of flying including granting flying licenses, pilots, certifying aircrafts for flight and issuing all rules and procedures governing Indian airports and airspace. Finally, the Airports Authority of India was entrusted with the responsibility of managing all national and international air ports and administering every aspect of air transport operation through the Air Traffic Control. With the opening up of the Indian economy in the early Nineties, aviation saw some important changes. Most importantly, the Air Corporation Act was repealed to end the monopoly of the public sector and private airlines were reintroduced.

Objectives of Civil Aviation Ministry

- a) To ensure aviation safety, security
- b) Effective regulation of air transport in the country in the liberalized environment
- c) Safe, efficient, reliable and widespread quality air transport services are provided at reasonable prices
- d) Flexibility to adapt to changing needs and circumstances
- e) To provide all players a level-playing field
- f) Encourage Private participation
- g) Encourage Trade, tourism and overall economic activity and growth
- h) Security of civil aviation operations is ensured through appropriate systems, policies, and practices

Lecture-32

STAGES OF DEVELOPMENT

Introduction

An airport system plan is a representation of the aviation facilities required to meet the immediate and future needs of a metropolitan area, region, state, or country. The system plan presents the recommendations for the general location and characteristics of new airports and heliports and the nature of expansion for existing ones to meet forecasts of aggregate demand. It identifies the aviation role of existing and recommended new airports and facilities. It includes the timing and estimated costs of development and relates airport system planning to the policy and objectives of the relevant jurisdiction. Its overall purpose is to determine the extent, type, nature, location, and timing of airport development needed to establish a viable, balanced, and integrated system of airports. It also provides the basis for detailed airport planning such as that contained in the airport master plan.

The airport system plan provides both broad and specific policies, plans, and programs required to establish a viable and integrated system of airports to meet the needs of the region. The objectives of the system plan include:

1. The orderly and timely development of a system of airports adequate to meet present and future aviation needs and to promote the desired pattern of regional growth relative to industrial, employment, social, environmental, and recreational goals.
2. The development of aviation to meet its role in a balanced and multimodal transportation system to foster the overall goals of the area as reflected in the transportation system plan and comprehensive development plan.
3. The protection and enhancement of the environment through the location and expansion of aviation facilities in a manner which avoids ecological and environmental impairment.
4. The provision of the framework within which specific airport programs may be developed consistent with the short- and long-range airport system requirements.
5. The implementation of land-use and airspace plans which optimize these resources in an often constrained environment.
6. The development of long-range fiscal plans and the establishment of priorities for airport financing within the governmental budgeting process.

7. The establishment of the mechanism for the implementation of the system plan through the normal political framework, including the necessary coordination between governmental agencies, the involvement of both public and private aviation and nonaviation interests, and compatibility with the content, standards, and criteria of existing legislation. The airport system planning process must be consistent with state, regional, or national goals for transportation, land use, and the environment.

The elements in a typical airport system planning process include the following:

1. Exploration of issues that impact aviation in the study area
2. Inventory of the current system
3. Identification of air transportation needs
4. Forecast of system demand
5. Consideration of alternative airport systems
6. Definition of airport roles and policy strategies
7. Recommendation of system changes, funding strategies, and airport development
8. Preparation of an implementation plan

Although the process involves many varied elements, the final product will result in the identification, preservation, and enhancement of the aviation system to meet current and future demand. The ultimate result of the process will be the establishment of a viable, balanced, and integrated system of airports.

Airport Classification

Airports are presently classified in the following manner:

1. International Airports:
2. Custom Airports:
3. Model Airports:
4. Other Domestic Airports:
5. Civil Enclaves in Defence Airport:

Lecture-33

SITE SELECTION

Introduction

The emphasis in airport planning is normally on the expansion and improvement of existing airports. However if an existing airport cannot be expanded to meet the future demand or the need for a new airport is identified in an airport system plan, a process to select a new airport site may be required.

- ✓ Identification
- ✓ Screening
- ✓ Operational capability
- ✓ Capacity potential
- ✓ Ground access
- ✓ Development costs
- ✓ Environmental consequences
- ✓ Compatibility with area-wide planning
- ✓ Selection

THE AIRPORT MASTER PLAN

An airport master plan is a concept of the ultimate development of a specific airport. The term development includes the entire airport area, both for aviation and nonaviation uses, and the use of land adjacent to the airport. It presents the development concept graphically and contains the data and rationale upon which the plan is based. Master plans are prepared to support expansion and modernization of existing airports and guide the development of new airports.

The overall objective of the airport master plan is to provide guidelines for future development which will satisfy aviation demand in a financially feasible manner and be compatible with the environment, community development, and other modes of transportation.

More specifically it is a guide for

1. Developing the physical facilities of an airport
2. Developing land on and adjacent to the airport
3. Determining the environmental effects of airport construction and operations

4. Establishing access requirements
5. Establishing the technical, economic and financial feasibility of proposed developments through a thorough investigation of alternative concepts
6. Establishing a schedule of priorities and phasing for the improvements proposed in the plan
7. Establishing an achievable financial plan to support the implementation schedule
8. Establishing a continuing planning process which will monitor conditions and adjust plan recommendations as circumstances warrant

Guidelines for completing an airport master plan are described by ICAO and in the United States by. A master plan report is typically organized as follows:

- ✓ Master plan vision, goals, and objectives
- ✓ Inventory of existing conditions
- ✓ Forecast of aviation demand
- ✓ Demand/capacity analysis and facility requirements
- ✓ Alternatives development
- ✓ Preferred development plan
- ✓ Implementation plan
- ✓ Environmental overview
- ✓ Airport plans package
- ✓ Stakeholder and public involvement

Lecture-34

OBSTRUCTION AND ZONING LAWS

IMAGINARY SURFACES

In order to determine whether an object is an obstruction to air navigation, several imaginary surfaces are established with relation to the airport and to each end of a runway. The size of the imaginary surfaces depends on the category of each runway (e.g., utility or transport) and on the type of approach planned for that end of the runway (e.g., visual, nonprecision instrument, or precision instrument).

The principal imaginary surfaces are shown in Fig. 6-25. They are described as follows:

- 1. *Primary surface.*** The primary surface is a surface longitudinally centered on a runway. When the runway is paved, the primary surface extends 200 ft beyond each end of the runway. When the runway is unpaved, the primary surface coincides with each end of the runway. The elevation of the primary surface is the same as the elevation of the nearest point on the runway centerline.
- 2. *Horizontal surface.*** The horizontal surface is a horizontal plane 150 ft above the established airport elevation, the perimeter of which is constructed by swinging arcs of specified radii from the center of each end of the primary surface of each runway and connecting each arcs by lines tangent to those arcs.
- 3. *Conical surface.*** The conical surface is a surface extending outward and upward from the periphery of the horizontal surface at a slope of 20 horizontal to 1 vertical for a horizontal distance of 4000 ft.
- 4. *Approach surface.*** The approach surface is a surface longitudinally centered on the extended runway centerline and extending outward and upward from each end of a runway at a designated slope based upon the type of available or planned approach to the runway.
- 5. *Transitional surface.*** Transitional surfaces extend outward and upward at right angles to the runway centerline plus the runway centerline extended at a slope of 7 to 1 from the sides of the primary surface up to the horizontal surface and from the sides of the approach surfaces. The width of the transitional surface provided from each edge of the approach surface is 5000 ft.

Lecture-35

AIRCRAFT CHARACTERISTICS

Introduction

One of the great challenges for airport planning and design is creating facilities that accommodate a very wide variety of aircraft. Aircraft vary widely in terms of their physical dimensions and performance characteristics, whether they be operated for commercial air service, cargo, or general aviation activities.

There are a large number of specifications for which aircraft may be categorized. Depending on the portion of the area of the airport, certain aircraft specifications become more critical. For example, aircraft weight is important for determining the thickness and strengths of the runway, taxiway, and apron pavements, and affects the takeoff and landing runway length requirements at an airport, which in turn to a large extent influences planning of the entire airport property.

The wingspan and the fuselage length influence the size of parking aprons, which in turn influences the configuration of the terminal buildings. Wingspan and turning radii dictate width of runways and taxiways, the distances between these traffic ways, and affects the required turning radius on pavement curves. An aircraft's passenger capacity has an important bearing on facilities within and adjacent to the terminal building.

Since the initial success of the Wright Flyer in 1903, fixed-wing aircraft have gone through more than 100 years of design enhancements, resulting in vastly improved performance, including the ability to fly at greater speeds and higher altitudes over larger ranges with more revenue generating carrying capacity (known as payload) at greater operating efficiencies. These improvements are primarily the results of the implementation of new technologies into aircraft specifications, ranging from materials from which the airframes are built, to the engines that power the aircraft. Of great challenge to airport planning and design, historically has been to adapt the airport environment to accommodate changes in aircraft physical and performance specifications. For example:

- The introduction of “cabin-class” aircraft, such as the Douglas DC-3, in the mid-1930s resulted in the need for airports to construct longer, paved runways from the shorter grass strips that previously existed.

- The introduction of aircraft equipped with turbofan and turbojet engines in the late 1950s added requirements for longer and stronger runways, facilities to mitigate jet-blast, and policies to reduce the impact of aircraft noise at and around the airport.
- The introduction of “jumbo-jet” or “heavy” aircraft, such as the Boeing-747, in the late 1960s added new requirements for runway specifications, as well as terminal area design requirements for accommodating large volumes of passengers and cargo.
- The proliferation of regional jet aircraft, introduced because of more efficient engine technologies, resulted in the need for airports to modify many terminal areas that had accommodated larger jets or smaller turbo-prop aircraft.

Most recently, the introduction of the world’s largest passenger aircraft, the Airbus A-380, as well as the smallest of certified general aviation jet aircraft, continues to affect design specifications of airport airfield and terminal areas.

Table below provides a summary of some of the important aircraft characteristics of some of the aircraft that make up the world’s commercial airline fleet. Many regional airlines use smaller aircraft with less than 50 seats, while the world’s major airlines use very large aircraft, with potential configurations for more than 800 seats.

| Manufacturer | Aircraft | Wing-span in m | Tail Height in m | Length in m | CMG in m | Wheel-base in m | MGW Outer to Outer in m | MTOW in kg | V_{REF} / Approach Speed |
|---------------------|-----------------|-----------------------|-------------------------|--------------------|-----------------|------------------------|--------------------------------|-------------------|---|
| Airbus | A-300 | 44.83 | 16.72 | 53.61 | 22.86 | 18.6 | 11 | 165000 | 137 |
| Airbus | A-300 -600 | (44.84) | (16.7) | (54.1) | (22.87) | (18.6) | (10.96) | (170500) | 137 |
| Airbus | A-310 | (43.9) | (15.87) | (46.66) | (19.49) | (15.22) | (10.96) | (164000) | 139 |
| Airbus | A-318 | (34.1) | (12.89) | (31.45) | (12.91) | (10.25) | (8.95) | (68000) | 121 |
| Airbus | A-318 Sharklet | (35.8) | (12.89) | (31.45) | (12.91) | (10.25) | (8.95) | (68000) | 121 |
| Airbus | A-319 | (34.1) | (12.11) | (33.84) | (13.7) | (11.04) | (8.95) | (75500) | 138 |
| Airbus | A-320 | (34.1) | (12.08) | (37.57) | (15.3) | (12.64) | (8.95) | (78000) | 136 |
| Boeing | 707-320B | (44.4) | (12.8) | (46.6) | (20.85) | | (8.02) | (151319) | 128 |
| Boeing | 707-200 | (28.40) | (9.08) | (37.80) | (17.00) | (17.62) | (5.90) | (54,885) | 139 |

* Under revision

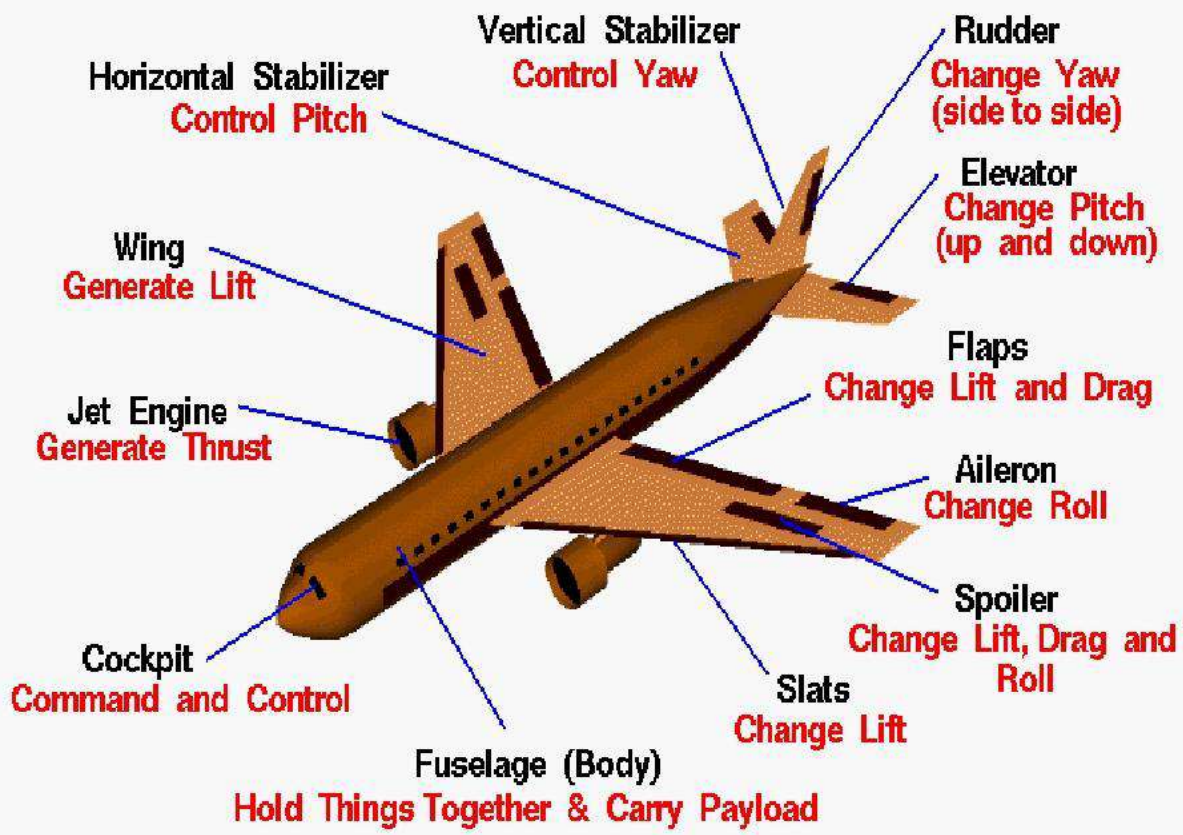

Lecture-36

ELEMENTS OF RUNWAY

Introduction

A runway is a rectangular area on the airport surface prepared for the takeoff and landing of aircraft. An airport may have one runway or several runways which are sited, oriented, and configured in a manner to provide for the safe and efficient use of the airport under a variety of conditions. Several of the factors which affect the location, orientation, and number of runways at an airport include local weather conditions, particularly wind distribution and visibility, the topography of the airport and surrounding area, the type and amount of air traffic to be serviced at the airport, aircraft performance requirements, and aircraft noise.

Runway Configurations

The term “runway configuration” refers to the number and relative orientations of one or more runways on an airfield. Many runway configurations exist. Most configurations are combinations of several basic configurations. The basic configurations are

- (1) single runways,
- (2) parallel runways,
- (3) intersecting runways, and
- (4) open-V runways.

Single Runway

It has been estimated that the hourly capacity of a single runway in **VFR** (visual flight rules) conditions is somewhere between 50 and 100 operations per hour, while in **IFR** (instrument flight rules) conditions this capacity is reduced to 50 to 70 operations per hour, depending on the composition of the aircraft mix and navigational aids available.

Parallel Runways

The capacities of parallel runway systems depend on the number of runways and on the spacing between the runways. Two, three, and four parallel runways are common. The spacing between parallel runways varies widely. For the purpose of this discussion, the spacing is classified as close, intermediate, and far, depending on the centreline separation between two parallel runways. Close parallel runways are spaced from a minimum of 700 ft (for air carrier airports) to less than 2500 ft. In IFR conditions an operation of one runway is dependent on the operation of

other runway. Intermediate parallel runways are spaced between 2500 ft to less than 4300 ft. In IFR conditions an arrival on one runway is independent of a departure on the other runway. Far parallel runways are spaced at least 4300 ft apart. If the terminal buildings are placed between parallel runways, runways are always spaced far enough apart to allow room for the buildings, the adjoining apron, and the appropriate taxiways. When there are four parallel runways, each pair is spaced close, but the pairs are spaced far apart to provide space for terminal buildings.

In VFR conditions, close parallel runways allow simultaneous arrivals and departures, that is, arrivals may occur on one runway while departures are occurring on the other runway. Aircraft operating on the runways must have wingspans less than 171 ft for centerline spacing at the minimum of 700 ft. The hourly capacity of a pair of parallel runways in VFR conditions varies greatly from 60 to 200 operations per hour depending on the aircraft mix and the manner in which arrivals and departures are processed on these runways. Similarly, in IFR conditions the hourly capacity of a pair of closely spaced parallel runways ranges from 50 to 60 operations per hour, of a pair of intermediate parallel runways from 60 to 75 operations per hour, and for a pair of far parallel runways from 100 to 125 operations per hour.

Intersecting Runways

Many airports have two or more runways in different directions crossing each other. These are referred to as intersecting runways. Intersecting runways are necessary when relatively strong winds occur from more than one direction, resulting in excessive crosswinds when only one runway is provided. When the winds are strong, only one runway of a pair of intersecting runways can be used, reducing the capacity of the airfield substantially. If the winds are relatively light, both runways can be used simultaneously. The capacity of two intersecting runways depends on the location of the intersection (i.e., midway or near the ends), the manner in which the runways are operated for takeoffs and landings, referred to as the runway use strategy, and the aircraft mix. The farther the intersection is from the takeoff end of the runway and the landing threshold, the lower is the capacity. The highest capacity is achieved when the intersection is close to the takeoff and landing threshold.

Open-V Runways

Runways in different directions which do not intersect are referred to as open-V runways. Like intersecting runways, open-V runways revert to a single runway when winds are strong from one direction. When the winds are light, both runways may be used simultaneously. The strategy which yields the highest capacity is when operations are away from the V and this is referred to as a diverging pattern. In VFR the hourly capacity for this strategy ranges from 60 to 180 operations per hour, and in IFR the corresponding capacity is from 50 to 80 operations per hour. When operations are toward the V it is referred to as a converging pattern and the capacity is reduced to 50 to 100 operations per hour in VFR and to between 50 and 60 operations per hour in IFR.

Combinations of Runway Configurations

From the standpoint of capacity and air traffic control, a single-direction runway configuration is most desirable. All other things being equal, this configuration will yield the highest capacity compared with other configurations. For air traffic control the routing of aircraft in a single direction is less complex than routing in multiple directions. Comparing the divergent configurations, the open-V runway pattern is more desirable than an intersecting runway configuration. In the open-V configuration an operating strategy that routes aircraft away from the V will yield higher capacities than if the operations are reversed. If intersecting runways cannot be avoided, every effort should be made to place the intersections of both runways as close as possible to their thresholds and to operate the aircraft away from the intersection rather than toward the intersection.

Lecture-37

ORIENTATION AND CONFIGURATION

Introduction

The orientation of a runway is defined by the direction, relative to magnetic north, of the operations performed by aircraft on the runway. Typically, but not always, runways are oriented in such a manner that they may be used in either direction. It is less preferred to orient a runway in such a way that operating in one direction is precluded, normally due to nearby obstacles.

In addition to obstacle clearance considerations, which will be discussed later in this chapter, runways are typically oriented based on the area's wind conditions. As such, an analysis of wind is essential for planning runways. As a general rule, the primary runway at an airport should be oriented as closely as practicable in the direction of the prevailing winds. When landing and taking off, aircraft are able to maneuver on a runway as long as the wind component at right angles to the direction of travel, the crosswind component, is not excessive.

The FAA recommends that runways should be oriented so that aircraft may be landed at least 95 percent of the time with allowable crosswind components not exceeding specified limits based upon the airport reference code associated with the critical aircraft that has the shortest wingspan or slowest approach speed. When the wind coverage is less than 95 percent a crosswind runway is recommended.

The allowable crosswind is 10.5 kn (12 mi/h) for Airport Reference Codes A-I and B-I, 13 kn (15 mi/h) for Airport Reference Codes A-II and B-II, 16 kn (18.5 mi/h) for Airport Reference Codes A-III, B-III, C-I, C-II, C-III and C-IV, and 20 knots (23 mph) for Airport Reference Codes A-IV through D-VI [5].

ICAO also specifies that runways should be oriented so that aircraft may be landed at least 95 percent of the time with crosswind components of 20 kn (23 mph) for runway lengths of 1500 m more, 13 kn (15 mi/h) for runway lengths between 1200 and 1500 m, and 10 kn (11.5 mi/h) for runway lengths less than 1200 m.

Once the maximum permissible crosswind component is selected, the most desirable direction of runways for wind coverage can be determined by examination of the average wind characteristics at the airport under the following conditions:

1. The entire wind coverage regardless of visibility or cloud ceiling
2. Wind conditions when the ceiling is at least 1000 ft and the visibility is at least 3 mi
3. Wind conditions when ceiling is between 200 and 1000 ft and/or the visibility is between . and 3 mi.

The first condition represents the entire range of visibility, from excellent to very poor, and is termed the all weather condition. The next condition represents the range of good visibility conditions not requiring the use of instruments for landing, termed visual meteorological condition (VMC). The last condition represents various degrees of poor visibility requiring the use of instruments for landing, termed instrument meteorological conditions (IMC). The 95 percent criterion suggested by the FAA and ICAO is applicable to all conditions of weather; nevertheless it is still useful to examine the data in parts whenever this is possible.

In the United States, weather records can be obtained from the Environmental Data and Information Service of the National Climatic Center at the National Oceanic and Atmospheric Administration located in Ashville, N.C., or from various locations found on the Internet.

Weather data are collected from weather stations throughout the United States on an hourly basis and recorded for analysis. The data collected include ceiling, visibility, wind speed, wind direction, storms, barometric pressure, the amount and type of liquid and frozen precipitation, temperature, and relative humidity. A report illustrating the tabulation and representation of some of the data of use in airport studies was prepared for the FAA. The weather records contain the percentage of time certain combinations of ceiling and visibility occur (e.g., ceiling, 500 to 900 ft; visibility, 3 to 6 mi), and the percentage of time winds of specified velocity ranges occur from different directions (e.g., from NNE, 4 to 7 mi/h). The directions are referenced to true north.

The Wind Rose

The appropriate orientation of the runway or runways at an airport can be determined through graphical vector analysis using a wind rose. A standard wind rose consists of a series of concentric circles cut by radial lines using polar coordinate graph paper. The radial lines are drawn to the scale of the wind magnitude such that the area between each pair of successive lines is centered on the wind direction.

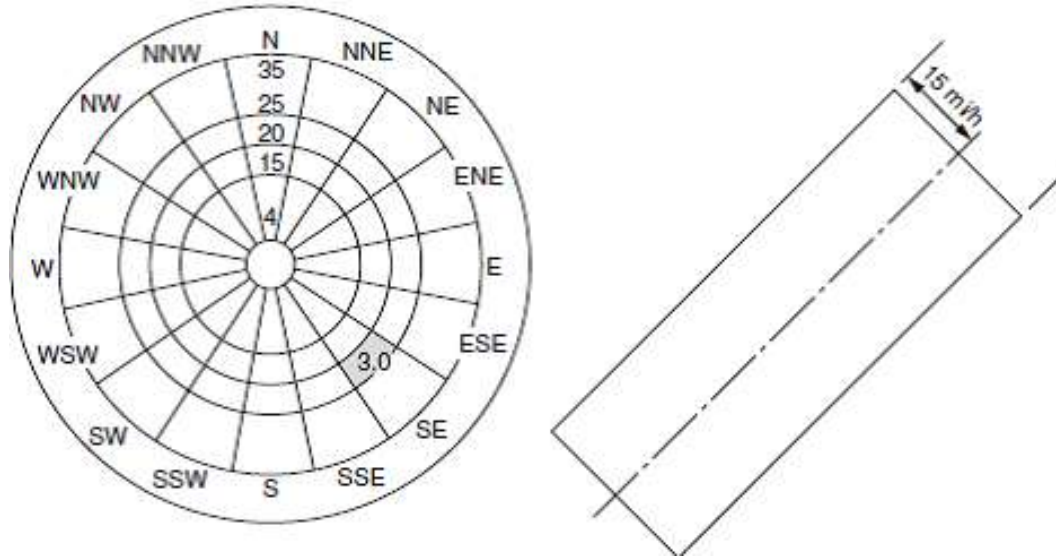

FIGURE: Wind rose coordinate system and template.

The shaded area indicates that the wind comes from the southeast (SE) with a magnitude between 20 and 25 mi/h. A template is also drawn to the same radial scale representing the crosswind component limits. A template drawn with crosswind component limits of 15 mi/h is shown on the right side of Fig. above. On this template three equally spaced parallel lines have been plotted. The middle line represents the runway center line, and the distance between the middle line and each outside line is, to scale, the allowable crosswind component (in this case, 15 mi/h). The template is placed over the wind rose in such a manner that the center line on the template passes through the center of the wind rose.

By overlaying the template on the wind rose and rotating the centreline of the template through the origin of the wind rose one may determine the percentage of time a runway in the direction of the centerline of the template can be used such that the crosswind component does not exceed 15 mi/h. Optimum runway directions can be determined from this wind rose by the use of the template, typically made on a transparent strip of material. With the center of the wind rose as a pivot point, the template is rotated until the sum of the percentages included between the outer lines is a maximum. If a wind vector from a segment lies outside either outer line on the template for the given direction of the runway, that wind vector must have a crosswind component which exceeds the allowable crosswind component plotted on the template. When one of the outer lines on the template divides a segment of wind direction, the fractional part is estimated visually to the nearest 0.1 percent. This procedure is consistent with the accuracy of the wind data and

assumes that the wind percentage within the sector is uniformly distributed within that sector. In practice, it is usually easier to add the percentages contained in the sectors outside of the two outer parallel lines and subtract these from 100 percent to find the percentage of wind coverage.

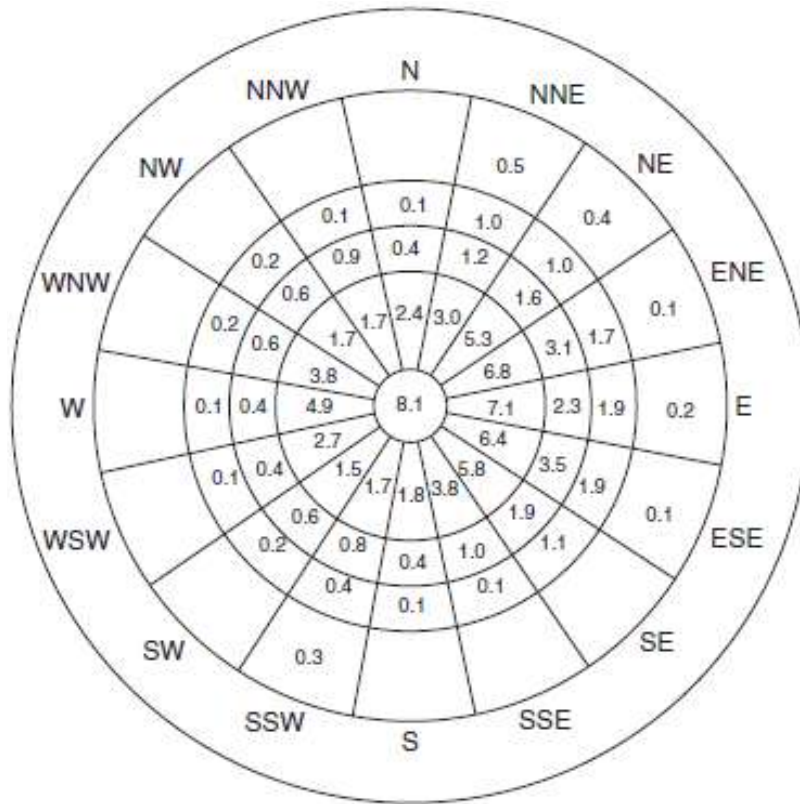

FIGURE: Wind data in wind rose format.

Lecture-38

BASIC RUNWAY LENGTH AND CORRECTIONS

Introduction

Length of runway decided taking following assumptions:

- Airport altitude at sea level
- Temperature at airport is standard (15⁰C)
- Runway is level in longitudinal direction
- No wind is blowing on runway
- No wind is blowing enroute to destination
- Aircraft is loaded to its full capacity
- Enroute temperature standard

The basic runway length is determined from the performance characteristics of aircraft using airport. The following cases are usually considered

Normal landing case

Normal takeoff case

Engine failure case

For jet engine aircraft all three cases are considered but for piston engine aircraft first and third case are usually considered. The longest runway length is finally adopted.

The landing case require that aircraft should come to stop within 60% of the landing distance. The full strength pavement is provided for entire landing distance.

The normal takeoff requires a clear way which is an area beyond the runway and is alignment with the centre line of the runway. The width of the clear way is not less than 150m (500 ft) and is kept free from obstruction. The clearway ground area any object should not protrude a plane upward at a slope of 1.25% from the runway end.

Engine failure case may require either a clearway or a stop way or both. Stopway is defined as the area beyond runway and centrally located in alignment with the centreline of the runway. It is used for decelerating the aircraft to stop during aborted takeoff. The strength of the stopway should be sufficient to carry the weight of the aircraft without causing any structural damage. If engine fail at a speed less than the designated engine failure speed, the pilot decelerate the

aircraft and use the stopway. If however engine fails at a speed higher than the designated speed, there is no other option to pilot take-off. The pilot may later take turn and make a landing. For piston engine aircrafts full strength pavement is provided for entire takeoff distance and the accelerated stop distance.

Correction for elevation, temperature and gradient

Airports are constructed in different elevation different atmospheric temperature and gradient, in contrast to the assumption made for basic runway length. Therefore correction required for changes in each components.

Correction in elevation

All other things being equal, the higher the field elevation of the airport, results the less dense the atmosphere, requiring longer runway lengths for the aircraft to get to the appropriate groundspeed to achieve sufficient lift for takeoff. For airports at elevation above sea level, the design runway length is 300 ft plus 0.03 ft for every foot above sea level. ICAO recommends the basic runway length should increase at rate of 7% per 100 m rise in elevation over MSL.

Correction in temperature

With rise of reference temperature same effect is there as that of elevation. The airport reference temperature defined as monthly mean of average daily temperature (T_a) for the hottest month of the year plus one third the difference of this temperature and monthly mean of the maximum daily temperature (T_w) for same month of the year.

$$\text{Reference Temperature} = T_a + (T_w - T_a)/3$$

ICAO recommends the basic runway length after have been corrected for elevation, should further increase at the rate of 1% for every 1⁰C increase of reference temperature.

If both correction increases more than 35% ICAO recommended specific site study should be conducted.

Correction for gradient

Steeper gradient require greater consumption of energy and longer length of runway to attain the desired speed. ICAO does not recommend any correction. FAA recommend after correction for elevation and temperature a further increase in runway length at rate of 20% for every 1 percent effective gradient.

Effective gradient is defined taking maximum difference between elevation between lowest point and highest point in the runway divided by length of the runway.

Surface Wind

Wind speed and direction at an airport also have a significance on runway length requirements. Simply, the greater the headwind the shorter the runway length required, and the greater the tailwind the longer the runway required. Further, the presence of crosswinds will also increase the amount of runway required for takeoff and landing. From the perspective of the planner, it is often estimated that for every 5 km of headwind, required runway length is reduced by approximately 3 percent and for every 7 km of tailwind, runway length requirements increase by approximately 7 percent. For airport planning purposes runway lengths are often designed assuming calm wind conditions.

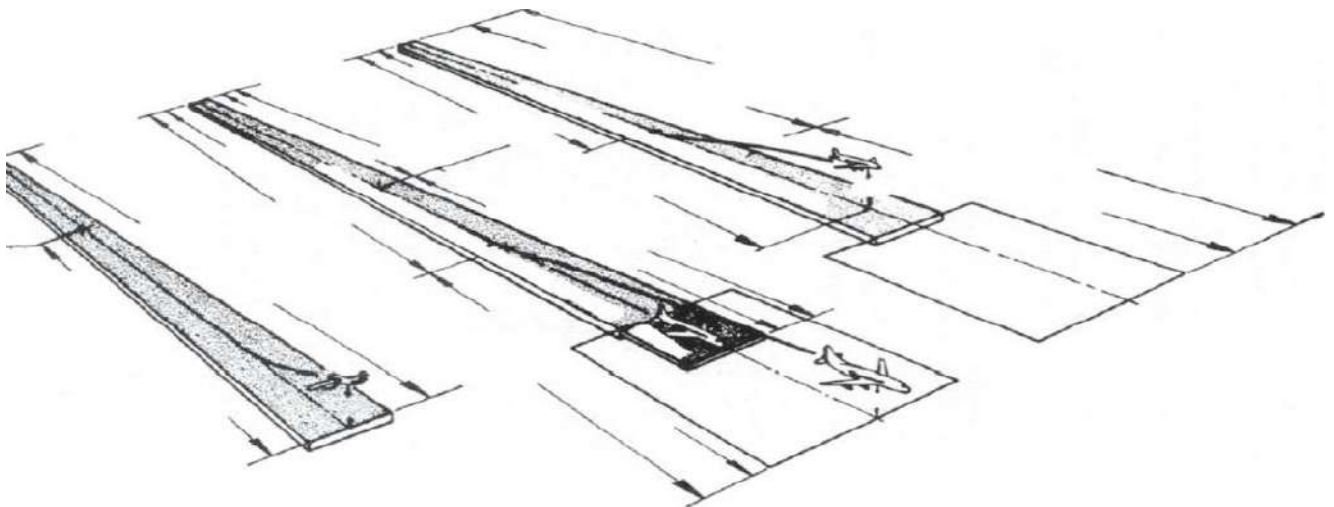

Lecture-39

GEOMETRIC ELEMENTS DESIGN

Taxiways and Taxi lanes

Taxiways are defined paths on the airfield surface which are established for the taxiing of aircraft and are intended to provide a linkage between one part of the airfield and another. Basically it established the connection between runway, terminal building and hanger. The term “dual parallel taxiways” refers to two taxiways parallel to each other on which airplanes can taxi in opposite directions. An apron taxiway is a taxiway located usually on the periphery of an apron intended to provide a through taxi route across the apron. A taxi lane is a portion of the aircraft parking area used for access between the taxiways and the aircraft parking positions. ICAO defines an aircraft stand taxi lane as a portion of the apron intended to provide access to the aircraft stands only.

In order to provide a margin of safety in the airport operating areas, the traffic ways must be separated sufficiently from each other and from adjacent obstructions. Minimum separations between the centerlines of taxiways, between the centerlines of taxiways and taxi lanes, and between taxiways and taxi lanes and objects are specified in order that aircraft may safely maneuver on the airfield.

Taxiway and Taxilane Separation Requirements

FAA Separation Criteria

The separation criteria adopted by the FAA are predicated upon the wingtips of the aircraft for which the taxiway and taxilane system have been designed and provide a minimum wingtip clearance on these facilities. The required separation between taxiways, between a taxiway and a taxilane, or between a taxiway and a fixed or movable object requires a minimum wingtip clearance of 0.2 times the wingspan of the most demanding aircraft in the airplane design group plus 10 ft. This clearance provides a minimum taxiway centerline to a parallel taxiway centerline or taxilane centerline separation of 1.2 times the wingspan of the most demanding aircraft plus 10 ft, and between a taxiway centerline and a fixed or movable object of 0.7 times the wingspan of the most demanding aircraft plus 10 ft. The taxilane centerline to a parallel taxilane centerline or fixed or movable object separation in the terminal area is predicated on a wingtip clearance of

approximately half of that required for an apron taxiway. This reduction in clearance is based on the consideration that taxiing speed is low in this area, taxiing is precise, and special guidance techniques and devices are provided. This requires a wingtip clearance or wingtip-to-object clearance of 0.1 times the wingspan of the most demanding aircraft plus 10 ft.

Sight Distance and Longitudinal Profile

As in the case of runways, the number of changes in longitudinal profile for taxiways is limited by sight distance and minimum distance between vertical curves. The FAA does not specify line of sight requirements for taxiways other than those discussed earlier related to runway and taxiway intersections. However, the sight distance along a runway from an intersecting taxiway needs to be sufficient to allow a taxiing aircraft to enter or cross the runway safely. The FAA specifies that from any point on the taxiway centerline the difference in elevation between that point and the corresponding point on a parallel runway, taxiway, or apron edge is 1.5 percent of the shortest distance between the points. ICAO requires that the surface of the taxiway should be seen for a distance of 150 m from a point 1.5 m above the taxiway for aerodrome code letter A runways, for a distance of 200 m from a point 2 m above the taxiway for aerodrome code letter B runways, and for a distance of 300 m from a point 3 m above the taxiway for aerodrome code letter C, D, or E runways. In regard to longitudinal profile of taxiways, the ICAO does not specify the minimum distance between the points of intersection of vertical curves. The FAA specifies that the minimum distance for both utility and transport category airports should be not less than the product of 100 ft multiplied by the sum of the absolute percentage values of change in slope.

Exit Taxiway Geometry

The function of exit taxiways, or runway turnoffs as they are sometimes called, is to minimize runway occupancy by landing aircraft. Exit taxiways can be placed at right angles to the runway or some other angle to the runway. When the angle is on the order of 30°, the term high-speed exit is often used to denote that it is designed for higher speeds than other exit taxiway configurations. In this chapter, specific dimensions for high-speed exit, right-angle exit (low-speed) taxiways are presented.

Aircraft paths in the test approximated a spiral. A compound curve is relatively easy to establish in the field and begins to approach the shape of a spiral, thus the reason for suggesting a compound curve. The following pertinent conclusions were reached as a result of the tests [13]:

1. Transport category and military aircraft can safely and comfortably turn off runways at speeds on the order of 60 to 65 mi/h on wet and dry pavements.
2. The most significant factor affecting the turning radius is speed, not the total angle of turn or passenger comfort.
3. Passenger comfort was not critical in any of the turning movements.
4. The computed lateral forces developed in the tests were substantially below the maximum lateral forces for which the landing gear was designed.
5. Insofar as the shape of the taxiway is concerned, a slightly widened entrance gradually tapering to the normal width of taxiway is preferred. The widened entrance gives the pilot more latitude in using the exit taxiway.
6. Total angles of turn of 30° to 45° can be negotiated satisfactorily. The smaller angle seems to be preferable because the length of the curved path is reduced, sight distance is improved, and less concentration is required on the part of the pilots.
7. The relation of turning radius versus speed expressed by the formula below will yield a smooth, comfortable turn on a wet or dry pavement when f is made equal to 0.13.
8. The curve expressed by the equation for R_2 should be preceded by a larger radius curve R_1 at exit speeds of 50 to 60 mi/h. The larger radius curve is necessary to provide a gradual transition from a straight tangent direction section to a curved path section. If the transition curve is not provided tire wear on large jet transports can be excessive.
9. Sufficient distance must be provided to comfortably decelerate an aircraft after it leaves the runway. It is suggested that for the present this distance be based on an average rate of deceleration of 3.3 ft/s^2 . This applies only to transport category aircraft. Until more experience is gained with this type of operation the stopping distance should be measured from the edge of the runway.

Location of Exit Taxiways

The location of exit taxiways depends on the mix of aircraft, the approach and touchdown speeds, the point of touchdown, the exit speed, the rate of deceleration, which in turn depends on the condition of the pavement surface, that is, dry or wet, and the number of exits. While the rules for flying transport aircraft are relatively precise, a certain amount of variability among pilots is bound to occur especially in respect to braking force applied on the runway and the distance from runway threshold to touchdown. The rapidity and the manner in which air traffic control can process arrivals is an extremely important factor in establishing the location of exit taxiways. The location of exit taxiways is also influenced by the location of the runways relative to the terminal area.

Holding Aprons

Holding aprons, holding pads, run-up pads, or holding bays as they are sometimes called, are placed adjacent to the ends of runways. The areas are used as storage areas for aircraft prior to takeoff. They are designed so that one aircraft can bypass another whenever this is necessary. For piston-engine aircraft the holding apron is an area where the aircraft instrument and engine operation can be checked prior to takeoff. The holding apron also provides for a trailing aircraft to bypass a leading aircraft in case the takeoff clearance of the latter must be delayed for one reason or another, or if it experiences some malfunction. There are many configurations of holding aprons. The important design criteria are to provide adequate space for aircraft to maneuver easily onto the runway irrespective of the position of adjacent aircraft on the holding apron and to provide sufficient room for an aircraft to bypass parked aircraft on the holding apron. The recommendations for the minimum separation between aircraft on holding aprons are the same as those specified for the taxiway object-free area.

Holding pads must be designed for the largest aircraft which will use the pad. The holding pad should be located so that all aircraft using the pad will be located outside both the runway and taxiway object-free area and in a position so as not to interfere with critical ILS signals.

Lecture-40

AIRPORT LAYOUTS AND TERMINAL BUILDING

Terminal building

The terminal area is the major interface between the airfield and the rest of the airport. It includes the facilities for passenger and baggage processing, cargo handling, and airport maintenance, operations, and administration activities. The passenger processing system is discussed at length in this chapter. Baggage processing, cargo handling, and apron requirements are also discussed relative to the terminal system.

The Passenger Terminal System

The passenger terminal system is the major connection between the ground access system and the aircraft. The purpose of this system is to provide the interface between the passenger airport access mode, to process the passenger for origination, termination, or continuation of an air transportation trip, and convey the passenger and baggage to and from the aircraft.

Components of the System

The passenger terminal system is composed of three major components. These components and the activities that occur within them are as follows:

1. The access interface where the passenger transfers from the access mode of travel to the passenger processing component. Circulation, parking, and curbside loading and unloading of passengers are the activities that take place within this component.
2. The processing component where the passenger is processed in preparation for starting, ending, or continuation of an air transportation trip. The primary activities that take place within this component are ticketing, baggage check-in, baggage claim, seat assignment, federal inspection services, and security.
3. The flight interface where the passenger transfers from the processing component to the aircraft. The activities that occur here include assembly, conveyance to and from the aircraft, and aircraft loading and unloading.

A number of facilities are provided to perform the functions of the passenger terminal system. These facilities are indicated for each of the components identified above.

The Access Interface

This component consists of the terminal curbs, parking facilities, and connecting roadways that enable originating and terminating passengers, visitors, and baggage to enter and exit the terminal. It includes the following facilities:

1. The enplaning and deplaning curb frontage which provide the public with loading and unloading for vehicular access to and from the terminal building
2. The automobile parking facilities providing short-term and long-term parking spaces for passengers and visitors, and facilities for rental cars, public transit, taxis, and limousine services
3. The vehicular roadways providing access to the terminal curbs, parking spaces, and the public street and highway system
4. The designated pedestrian walkways for crossing roads including tunnels, bridges, and automated devices which provide access between the parking facilities and the terminal building
5. The service roads and fire lanes which provide access to various facilities in the terminal and to other airport facilities, such as air freight, fuel truck stands, and maintenance.

The ground access system at an airport is a complex system of roadways, parking facilities, and terminal access curb fronts. This complexity is illustrated in Fig. 10-1 which shows the various ground access system facilities and directional flows at Greater Pittsburgh International Airport.

The Processing System

The terminal is used to process passengers and baggage for the interface with aircraft and the ground transportation modes. It includes the following facilities:

1. The airline ticket counters and offices used for ticket transactions, baggage check-in, flight information, and administrative personnel and facilities
2. The terminal services space which consists of the public and nonpublic areas such as concessions, amenities for passengers and visitors, truck service docks, food preparation areas, and food and miscellaneous storage
3. The lobby for circulation and passenger and visitor waiting
4. Public circulation space for the general circulation of passengers and visitors consisting of such areas as stairways, escalators, elevators, and corridors
5. The outbound baggage space which is a nonpublic area for sorting and processing baggage for departing flights

6. The intraline and interline baggage space used for processing baggage transferred from one flight to another on the same or different airlines
7. The inbound baggage space which is used for receiving baggage from an arriving flight, and for delivering baggage to be claimed by the arriving passenger
8. Airport administration and service areas used for airport management, operations, and maintenance facilities
9. The federal inspection service facilities which are the areas for processing passengers arriving on international flights, as well as performing agricultural inspections, and security functions.

Lecture-41

AIRPORT MAKING AND LIGHTING-I

Introduction

Visual aids assist the pilot on approach to an airport, as well as navigating around an airfield and are essential elements of airport infrastructure. As such, these facilities require proper planning and precise design.

These facilities may be divided into three categories: lighting, marking, and signage. Lighting is further categorized as either approach lighting or surface lighting. Specific lighting systems described in this chapter include

1. Approach lighting
2. Runway threshold lighting
3. Runway edge lighting
4. Runway centerline and touchdown zone lights
5. Runway approach slope indicators
6. Taxiway edge and centerline lighting

The proper placement of these systems is described in this chapter but no attempt has been made to describe in detail the hardware or its installation. Airfield marking and signage includes

1. Runway and taxiway pavement markings
2. Runway and taxiway guidance sign systems

Airfield lighting, marking, and signage facilities provide the following functions:

1. Ground to air visual information required during landing
2. The visual requirements for takeoff and landing
3. The visual guidance for taxiing

The Requirements for Visual Aids

Since the earliest days of flying, pilots have used ground references for navigation when approaching an airport, just as officers on ships at sea have used landmarks on shore when approaching a harbor. Pilots need visual aids in good weather as well as in bad weather and during the day as well as at night.

In the daytime there is adequate light from the sun, so artificial lighting is not usually required but it is necessary to have adequate contrast in the field of view and to have a suitable pattern of brightness so that the important features of the airport can be identified and oriented with respect to the position of the aircraft in space. These requirements are almost automatically met during the day when the weather is clear.

The runway for conventional aircraft always appears as a long narrow strip with straight sides and is free of obstacles. It can therefore be easily identified from a distance or by flying over the field. Therefore, the perspective view of the runway and other identifying reference landmarks are used by pilots as visual aids for orientation when they are approaching the airport to land. Experience has demonstrated that the horizon, the runway edges, the runway threshold, and the centreline of the runway are the most important elements for pilots to see.

In order to enhance the visual information during the day, the runway is painted with standard marking patterns. The key elements in these patterns are the threshold, the centerline, the edges, plus multiple parallel lines to increase the perspective and to define the plane of the surface.

During the day when visibility is poor and at night, the visual information is reduced by a significant amount over the clear weather daytime scene. It is therefore essential to provide visual aids which will be as meaningful to pilots as possible.

The Airport Beacon

Beacons are lighted to mark an airport. They are designed to produce a narrow horizontal and vertical beam of high-intensity light which is rotated about a vertical axis so as to produce approximately 12 flashes per minute for civil airports and 18 flashes per minute for military airports. The flashes with a clearly visible duration of at least 0.15 s are arranged in a white-green sequence for land airports and a white yellow sequence for landing areas on water. Military airports use a double white flash followed by a longer green or yellow flash to

differentiate them from civil airfields. The beacons are mounted on top of the control tower or similar high structure in the immediate vicinity of the airport.

Obstruction Lighting

Obstructions are identified by fixed, flashing, or rotating red lights or beacons. All structures that constitute a hazard to aircraft in flight or during landing or takeoff are marked by obstruction lights having a horizontally uniform intensity duration and a vertical distribution design to give maximum range at the lower angles (1.5° to 8°) from which a colliding approach would most likely come.

The Aircraft Landing Operation

An aircraft approaching a runway in a landing operation may be visualized as a sequence of operations involving a transient body suspended in a three-dimensional grid that is approaching a fixed two-dimensional grid. While in the air, the aircraft can be considered as a point mass in a three-dimensional orthogonal coordinate system in which it may have translation along three coordinate directions and rotation about three axes. If the three coordinate axes are aligned horizontal, vertical, and parallel to the end of the runway, the directions of motion can be described as lateral, vertical, and forward. The rotations are normally called pitch, yaw, and roll, for the horizontal, vertical, and parallel axes, respectively. During a landing operation, pilots must control and coordinate all six degrees of freedom of the aircraft so as to bring the aircraft into coincidence with the desired approach or reference path to the touchdown point on the runway. In order to do this, pilots need translation information regarding the aircraft's alignment, height, and distance, rotation information regarding pitch, yaw, and roll, and information concerning the rate of descent and the rate of closure with the desired path.

Alignment Guidance

Pilots must know where their aircraft is with respect to lateral displacement from the centerline of the runway. Most runways are from 75 to 200 ft wide and from 3000 to 12,000 ft long. Thus any runway is a long narrow ribbon when first seen from several thousand feet above. The predominant alignment guidance comes from longitudinal lines that constitute the centerline and edges of the runway. All techniques, such as painting, lighting, or surface treatment that develop contrast and emphasize these linear elements are helpful in providing alignment information.

Height Information

The estimation of the height above ground from visual cues is one of the most difficult judgments for pilots. It is simply not possible to provide good height information from an approach lighting system. Consequently the best source of height information is the instrumentation in the aircraft. However, use of these instruments often requires the availability of precision ground or satellite based navigation technologies.

Approach Lighting

Approach lighting systems (ALS) are designed specifically to provide guidance for aircraft approaching a particular runway under night time or other low-visibility conditions. While under night time conditions it may be possible to view approach lighting systems from several miles away, under other low-visibility conditions, such as fog, even the most intense ALS systems may only be visible from as little as 2500 ft from the runway threshold.

Studies of the visibility in fog have shown that for a visual range of 2000 to 2500 ft it would be desirable to have as much as 200,000 candelas (cd) available in the outermost approach lights where the slant range is relatively long. Under these same conditions the optimum intensity of the approach lights near the threshold should be on the order of 100 to 500 cd. A transition in the intensity of the light that is directed toward the pilot is highly desirable in order to provide the best visibility at the greatest possible range and to avoid glare and the loss of contrast sensitivity and visual acuity at short range.

System Configurations

The configurations which have been adopted are the Calvert system shown in Fig. 'a' which has been widely used in Europe and other parts of the world, the ICAO category II and category III system shown in Fig. 'b', and the four system configurations which have been adopted by the FAA in the United States. The FAA publishes criteria for the establishment of the approach lighting systems and other navigation facilities at airports. Approach lights are normally mounted on frangible pedestals of varying height to improve the perspective of the pilot in approaching a runway.

MALS system.

At smaller airports where precision approaches are not required, a medium ALS with sequential flashers (MALSF) or with sequenced flashers (MALS) is adequate. The system is only 1400 ft long compared to a length of 2400 ft for a precision approach system. It is therefore much more economical, an important factor at small airports. The runway alignment indicator lights and these are only provided in the outermost 400 ft of the 1400-ft system to improve pilot recognition of the runway approach in areas where there are distracting lights in the vicinity of the airport. The MALS system does not have the runway alignment indicator lights or the sequential flashers. At international airports in the United States, the 2400-ft ALSs are often extended to a distance of 3000 ft to conform to international specifications.

Sequenced-flashing high-intensity lights are available for airport use and are installed as supplements to the standard approach lighting system at those airports where very low visibilities occur frequently.

These lights operate from the stored energy in a capacitor which is discharged through the lamp in approximately 5 ms and may develop as much as 30 million cd of light. They are mounted in the same pedestals as the light bars. The lights are sequence-fired, beginning with the unit farthest from the runway. The complete cycle is repeated every 2s. This results in a brilliant ball of light continuously moving toward the runway.

Since the very bright light can interfere with the eye adaptation of the pilot, condenser discharge lamps are usually omitted in the 1000 ft of the approach lighting system nearest the runway.

Visual Approach Slope Aids

Visual approach slope aids are lighting systems designed to provide a measure of vertical guidance to aircraft approaching a particular runway. The principle of these aids is to provide color-based identification to the pilot indicating their variation from a desired altitude and descent rate while on approach. The two most common visual approach slope aids are the visual approach slope indicator (VASI), and the precision approach path indicator (PAPI).

Visual Approach Slope Indicator

The visual approach slope indicator (VASI) is a system of lights which acts as an aid in defining the desired glide path in relatively good weather conditions. VASI lighting intensities are designed to be visible from 3 to 5 mi during the day and up to 20 mi at night. There are a number of different VASI configurations depending on the desired visual range, the type of aircraft, and

whether large wide bodied aircraft will be using the runway. Each group of lights transverse to the direction of the runway is referred to as a *bar*. The downwind bar is typically located between 125 and 800 ft from the runway threshold, each subsequent bar is located between 500 and 1000 ft from the previous bar. A bar is made up of one, two, or three light units, referred to as *boxes*. The basic VASI-2 system, is a two-bar system consisting of four boxes. The bar that is nearest to the runway threshold is referred to as the *downwind bar*, and the bar that is farthest from the runway threshold is referred to as the *upwind bar*. If pilots are on the proper glide path, the downwind bar appears white and the upwind bar appears red; if pilots are too low, both bars appear red; and if they are too high both bars appear white.

In order to accommodate large wide bodied aircraft where the height of the eye of the pilot is much greater than in smaller jets, a third upwind bar is added. For wide bodied aircraft the middle bar becomes the downwind bar and the third bar is the upwind bar. In other words, pilots of large wide bodied aircraft ignore the bar closest to the runway threshold and use the other two bars for visual reference..

The more common systems in use in the United States are the VASI-2, VASI-4, VASI-12, and VASI-16. VASI systems are particularly useful on runways that do not have an instrument landing system or for aircraft not equipped to use an instrument landing system.

Precision Approach Path Indicator

The FAA presently prefers the use of another type of visual approach indicator called the *precision approach path indicator* (PAPI) [20]. This system gives more precise indications to the pilot of the approach path of the aircraft and utilizes only one bar as opposed to the minimum of two required by the VASI system. The system consists of a unit with four lights on either side of the approach runway.

Threshold Lighting

During the final approach for landing, pilots must make a decision to complete the landing or “execute a missed approach.” The identification of the threshold is a major factor in pilot decisions to land or not to land. For this reason, the region near the threshold is given special lighting consideration. The threshold is identified at large airports by a complete line of green lights extending across the entire width of the runway, and at small airports by four green lights on each side of the threshold. The lights on either side of the runway threshold may be elevated.

Threshold lights in the direction of landing are green but in the opposite direction these lights are red to indicate the end of the runway.

Runway Lighting

After crossing the threshold, pilots must complete a touchdown and roll out on the runway. The runway visual aids for this phase of landing are designed to give pilots information on alignment, lateral displacement, roll, and distance. The lights are arranged to form a visual pattern that pilots can easily interpret.

At first, night landings were made by floodlighting the general area. Various types of lighting devices were used, including automobile headlights, arc lights, and search lights. Boundary lights were added to outline the field and to mark hazards such as ditches and fences. Gradually, preferred landing directions were developed, and special lights were used to indicate these directions. Floodlighting was then restricted to the preferred landing directions, and runway edge lights were added along the landing strips. As experience was developed, the runway edge lights were adopted as visual aids on a runway. This was followed by the use of runway center line and touchdown zone lights for operations in very poor visibility. FAA Advisory Circular 150/5340-30C provides guidance for the design and installation of runway and taxiway lighting systems.

Runway Edge Lights

Runway edge lighting systems outline the edge of runways during night time and reduced visibility conditions. Runway edge lights are classified by intensity, high intensity (HIRL), medium intensity (MIRL), and low intensity (LIRL). LIRLs are typically installed on visual runways and at rural airports. MIRLs are typically installed on visual runways at larger airports and on non-precision instrument runways, HIRLs are installed on precision-instrument runways. Elevated runway lights are mounted on frangible fittings and project no more than 30 in above the surface on which they are installed. They are located along the edge of the runway not more than 10 ft from the edge of the full-strength pavement surface. The longitudinal spacing is not more than 200 ft. Runway edge lights are white, except that the last 2000 ft of an instrument runway in the direction of aircraft operations these lights are yellow to indicate a caution zone.

Runway Center line and Touchdown Zone Lights

As an aircraft traverses over the approach lights, pilots are looking at relatively bright light sources on the extended runway center line. Over the runway threshold, pilots continue to look along the center line, but the principal source of guidance, namely, the runway edge lights, has

moved far to each side in their peripheral vision. The result is that the central area appears excessively black, and pilots are virtually flying blind, except for the peripheral reference information, and any reflection of the runway pavement from the aircraft's landing lights. Attempts to eliminate this "black hole" by increasing the intensity of runway edge lights have proven ineffective. In order to reduce the black hole effect and provide adequate guidance during very poor visibility conditions, runway center line and touchdown zone lights are typically installed in the pavement.

Runway End Identifier Lights

Runway end identifier lights (REIL) are installed at airports where there are no approach lights to provide pilots with positive visual identification of the approach end of the runway. The system consists of a pair of synchronized white flashing lights located on each side of the runway threshold and is intended for use when there is adequate visibility.

Lecture-42

AIRPORT MAKING AND LIGHTING-II

Taxiway Lighting

Either after a landing or on the way to takeoff, pilots must maneuver the aircraft on the ground on a system of taxiways to and from the terminal and hangar areas. Taxiway lighting systems are provided for taxiing at night and also during the day when visibility is very poor, particularly at commercial service airports. The following overall guidance should be applied in determining the lighting, marking, and signing visual aid requirements for taxiways:

- In order to avoid confusion with runways, taxiways must be clearly identified.
- Runway exits need to be readily identified. This is particularly true for high-speed runway exits so that pilots can be able to locate these exits 1200 to 1500 ft before the turnoff point.
- Adequate visual guidance along the taxiway must be provided.
- Specific taxiways must be readily identified.
- The intersections between taxiways, the intersections between runways and taxiways, and runway-taxiway crossings need to be clearly marked.
- The complete taxiway route from the runway to the apron and from the apron to the runway should be easily identified. There are two primary types of lights used for the designation of taxiways. One type delineates the edges of taxiways and the other type delineates the center line of the taxiway.

Taxiway Edge Lights

Taxiway edge lights are elevated blue colored bidirectional lights usually located at intervals of not more than 200 ft on either side of the taxiway. The exact spacing is influenced by the physical layout of the taxiways. Straight sections of taxiways generally require edge light spacing in 200-ft intervals, or at least three lights equally spaced for taxiway straight line sections less than 200 ft in length.

Closer spacing is required on curves. Light fixtures are located not more than 10 ft from the edge of full strength pavement surfaces. Taxiway centerline lights are in-pavement bidirectional lights placed in equal intervals over taxiway centerline markings. Taxiway centreline lights are

green, except in areas where the taxiway intersects with a runway, where the green and yellow lights are placed alternatively.

Research and experience have demonstrated that guidance from centerline lights is superior to that from edge lights, particularly in low visibility conditions.

For normal exits, the centerline lights are terminated at the edge of the runway. At taxiway intersections the lights continue across the intersection. For long-radius high-speed exit taxiways, the taxiway lights are extended onto the runway from a point 200 ft back from the point of curvature (PC) of the taxiway to the point of tangency of the central curve of the taxiway. Within these limits the spacing of lights is 50 ft. These lights are offset 2 ft from the runway centerline lights and are gradually brought into alignment with the centerline of the taxiway. Where the taxiways intersect with runways and aircraft are required to hold short of the runway, several yellow lights spaced at 5-ft intervals are placed transversely across the taxiway.

Runway Guard Lights

Runway guard lights (RGLs) are in-pavement lights located on taxiways at intersections of runways to alert pilots and operators of airfield ground vehicles that they are about to enter onto an active runway. RGLs are located across the width of the taxiway, approximately 2 ft from the entrance to a runway, spaced at approximately 10-ft intervals,

Runway Stop Bar

Similar to runway guard lights, runway stop bar lights are in-pavement lights on taxiways at intersections with runways. As opposed to RGLs that provide warning to pilots approaching a runway, runway stop bar lights are designed to act as “stop” lights, directing aircraft and vehicles on the taxiway not to enter the runway environment. Runway stop bar lights are activated with red illuminations during periods of runway occupancy or other instances where entrance from the taxiway to the runway is prohibited. In-pavement runway stop bar lighting is typically installed in conjunction with elevated runway guard lights located outside the width of the pavement.

Runway and Taxiway Marking

In order to aid pilots in guiding the aircraft on runways and taxiways, pavements are marked with lines and numbers. These markings are of benefit primarily during the day and dusk. At night, lights are used to guide pilots in landing and maneuvering at the airport. White is used for all markings on runways and yellow is used on taxiways and aprons.

Runways

The FAA has grouped runways for marking purposes into three classes:

- (1) Visual, or “basic” runways,
- (2) Nonprecision instrument runways, and
- (3) Precision instrument runways.

The visual runway is a runway with no straight-in instrument approach procedure and is intended solely for the operation of aircraft using visual approach procedures. The nonprecision instrument runway is one having an existing instrument approach procedure utilizing air navigation facilities with only horizontal guidance (typically VOR or GPS-based RNAV approaches without vertical guidance) for which a straight-in nonprecision approach procedure has been approved. A precision instrument runway is one having an existing instrument approach procedure utilizing a precision instrument landing system or approved GPS-based RNAV (area navigation) or RNP (required navigation performance) precision approach. Runways that have a published approach based solely on GPS-based technologies are known as GPS runways.

Runway markings include runway designators, center lines, threshold markings, aiming points, touchdown zone markings, and side stripes. Depending on the length and class of runway and the type of aircraft operations intended for use on the runway, all or some of the above markings are required.

Runway Designators

The end of each runway is marked with a number, known as a runway designator, which indicates the approximate magnetic azimuth (clockwise from magnetic north) of the runway in the direction of operations. The marking is given to the nearest 10° with the last digit omitted. Thus a runway in the direction of an azimuth of 163° would be marked as runway 16 and this runway would be in the approximate direction of south-south-east. Therefore, the east end of an

east-west runway would be marked 27 (for 270° azimuth) and the west end of an east-west runway would be marked 9 (for a 90° azimuth). If there are two parallel runways in the east-west direction, for example, these runways would be given the designation 9L-27R and 9R-27L to indicate the direction of each runway and their position (L for left and R for right) relative to each other in the direction of aircraft operations. If a third parallel runway existed in this situation it has traditionally been given the designation 9C-27C to indicate its direction and position relative (C for center) to the other runways in the direction of aircraft operations.

Runway Threshold Markings

Runway threshold markings identify to the pilot the beginning of the runway that is safe and available for landing. Runway threshold markings begin 20 ft from the runway threshold itself. Runway threshold markings consist of two series of white stripes, each stripe 150 ft in length and 5.75 ft in width, separated about the centerline of the runway. On each side of the runway centerline, a number of threshold marking stripes are placed, For example, for a 100-ft runway, eight stripes are required, in two groups of four are placed about the centerline. Stripes within each set are separated by 5.75 ft. Each set of stripes is separated by 11.5 ft about the runway centerline.

Centerline Markings

Runway centerline markings are white, located on the centerline of the runway, and consist of a line of uniformly spaced stripes and gaps. The stripes are 120 ft long and the gaps are 80 ft long. Adjustments to the lengths of stripes and gaps, where necessary to accommodate runway length, are made near the runway midpoint. The minimum width of stripes is 12 in for visual runways, 18 in for nonprecision instrument runways, and 36 in for precision instrument runways. The purpose of the runway centerline markings is to indicate to the pilot the center of the runway and to provide alignment guidance on landing and takeoff.

Aiming Points

Aiming points are placed on runways of at least 4000 ft in length to provide enhanced visual guidance for landing aircraft. Aiming point markings consist of two bold stripes, 150 ft long, 30

ft wide, spaced 72 ft apart symmetrically about the runway centerline, and beginning 1020 ft from the threshold.

Touchdown Zone Markings

Runway touchdown zone markings are white and consist of groups of one, two, and three rectangular bars symmetrically arranged in pairs about the runway centerline. These markings begin 500 ft from the runway threshold. The bars are 75 ft long, 6 ft wide, with 5 ft spaces between the bars, and are longitudinally spaced at distances of 500 ft along the runway. The inner stripes are placed 36 ft on either side of the runway centerline. For runways less than 150 ft in width, the width and spacing of stripes may be proportionally reduced. Where touchdown zone markings are installed on both runway ends on shorter runways, those pairs of markings which would extend to within 900 ft of the runway midpoint are eliminated.

Side Stripes

Runway side stripes consist of continuous white lines along each side of the runway to provide contrast with the surrounding terrain or to delineate the edges of the full strength pavement. The maximum distance between the outer edges of these markings is 200 ft and these markings have a minimum width of 3 ft for precision instrument runways and are at least as wide as the width of the centerline stripes on other runways.

Displaced Threshold Markings

At some airports it is desirable or necessary to “displace” the runway threshold on a permanent basis. A displaced threshold is one which has been moved a certain distance from the end of the runway. Most often this is necessary to clear obstructions in the flight path on landing. The displacement reduces the length of the runway available for landings, but takeoffs can use the entire length of the runway.

These markings consist of arrows and arrow heads to identify the displaced threshold and a threshold bar to identify the beginning of the runway threshold itself. Displaced threshold arrows are 120 ft in length, separated longitudinally by 80 ft for the length of the displaced threshold. Arrow heads are 45 ft in length, placed 5 ft from the threshold bar. The threshold bar is 5 ft in width and extends the width of the runway at the threshold.

Blast Pad Markings

In order to prevent erosion of the soil, many airports provide a paved *blast pad* 150 to 200 ft in length adjacent to the runway end. Similarly, some airport runways have a *stopway* which is only designed to support aircraft during rare aborted takeoffs or landing overruns and is not designed as a full strength pavement. Since these paved areas are not designed to support aircraft and yet may have the appearance of being so designed, markings are required to indicate this.

Centerline and Edge Markings

The centerline of the taxiway is marked with a single continuous 6-in yellow line. On taxiway curves, the taxiway centerline marking continues from the straight portion of the taxiway at a constant distance from the outside edge of the curve. At taxiway intersections which are designed for aircraft to travel straight through the intersection, the centerline markings continue straight through the intersection. At the intersection of a taxiway with a runway end, the centerline stripe of the taxiway terminates at the edge of the runway.

Taxiway Hold Markings

For taxiway intersections where there is an operational need to hold aircraft, a dashed yellow holding line is placed perpendicular to and across the centerline of both taxiways. When a taxiway intersects a runway or a taxiway enters an instrument landing system critical area, a holding line is placed across the taxiway. The holding line for a taxiway intersecting a runway consists of two solid lines of yellow stripes and two broken lines of yellow stripes placed perpendicular to the centerline of the taxiway and across the width of the taxiway. The solid lines are always placed on the side where the aircraft is to hold. The holding line for an instrument landing system critical area consists of two solid lines placed perpendicular to the taxiway centerline and across the width of the taxiway joined with three sets of two solid lines symmetrical about and parallel to the taxiway center line.

Taxiway Shoulders

In some areas on the airfield, the edges of taxiways may not be well defined due to their adjacency to other paved areas such as aprons and holding bays. In these areas, it is prudent to mark the edges of taxiways with shoulder markings. Taxiway shoulder markings are yellow in

colour, and are often painted on top of a green background. The shoulder markings consist of 3-ft-long yellow stripes placed perpendicular to the taxiway edge stripes. On straight sections of the taxiway, the marks are placed at a maximum spacing of 100 ft. On curves, the marks are placed on a maximum of 50 ft apart between the curve tangents.

Enhanced Taxiway Markings

Beginning in 2008, all airports serving commercial air carriers are required to mark certain critical areas of the airfield with enhanced taxiway markings. These markings are designed to provide additional guidance and warning to pilots of runway intersections.

Enhanced markings consist primarily of yellow-painted lines, using paint mixtures with imbedded glass beads to enhance visibility. In addition, yellow markings must be marked on top of a darkened black background.

Taxiway centerlines are enhanced for 150 ft from the runway hold-short markings. The centerline enhancements include dashed yellow lines 9 ft in length, separated longitudinally by 3 ft. These yellow lines are placed 6 in from each end of the existing centerline.

Closed Runway and Taxiway Markings

When runways or taxiways are permanently or temporarily closed to aircraft, yellow crosses are placed on these trafficways. For permanently closed runways, the threshold, runway designation, and touchdown markings are obliterated and crosses are placed at each end and at 1000 ft intervals. For temporarily closed runways, the runway markings are not obliterated, the crosses are usually of a temporary type and are only placed at the runway ends. For permanently closed taxiways, a cross is placed on the closed taxiway at each entrance to the taxiway. For temporarily closed taxiways barricades with orange and white markings are normally erected at the entrances.

Lecture-43

INSTRUMENTAL LANDING SYSTEMS AND AIR NAVIGATION AIDS

Aids to navigation, known as NAVAIDS, can be broadly classified into two groups, ground-based systems and satellite-based systems. Each system is complimented by systems installed in the cockpit.

Ground-Based Systems

Non directional Beacon

The oldest active ground-based navigational aid is the nondirectional beacon (NDB). The NDB emits radio frequency signals on frequencies between 400 and 1020 Hz modulation. NDBs are typically mounted on a pole approximately 35 ft tall. They may be located on or off airport property, at least 100 ft clear of metal buildings, power lines, or metal fences. While the NDB is quickly being phased out in the United States, it is still a very common piece of navigational equipment in other parts of the world, particularly in developing nations. Figure 3-8 provides an illustration of an NDB.

Aircraft navigate using the NDB by referencing an automatic direction finder (ADF) located on the aircraft's panel. The ADF simply points toward the location of the NDB. Figure 3-9 illustrates an ADF system.

Very High Frequency Omnidirectional Radio

The advances in radio and electronics during and after World War II led to the installation of the very high frequency omnidirectional (VOR) radio stations. These stations are located on the ground and send out radio signals in all directions. Each signal can be considered as a course or a route, referred to as a radial that can be followed by a aircraft. In terms of 1° intervals, there are 360 courses or routes that are radiated from a VOR station, from 0° pointing toward magnetic north increasing to 359° in a clockwise direction. The VOR transmitter station is a small square building topped with what appears to be a white derby hat. It broadcasts on a frequency just above that of FM radio stations. The very high frequencies it uses are virtually free of static. The system of VOR stations establish the network of airways and jet routes and are also essential to area navigation. The range of a VOR station varies but is usually less than 200 nm. A typical VOR beacon is illustrated in Fig. 3-10.

Aircraft equipped with a VOR receiver in the cockpit have a dial for tuning in the desired VOR frequency. A pilot can select the VOR radial or route he wishes to follow to the VOR station. In the cockpit there is also an omnibearing selector (OBS) which indicates the heading of the aircraft relative to the direction of the desired radial and whether the aircraft is to the right or left of the radial. An illustration of an OBS is provided in Fig. 3-11.

Distance Measuring Equipment

Distance measuring equipment (DME) has traditionally been installed at VOR stations in the United States. The DME shows the pilot the slant distance between the aircraft and a particular VOR station. Since it is the air distance in nautical miles that is measured, the receiving equipment in an aircraft flying at 35,000 ft directly over the DME station would read 5.8 nm.

An en route air navigation aid which best suited the tactical needs of the military was developed by the Navy in the early 1950s. This aid is known as TACAN, which stands for tactical air navigation. This aid combines azimuth and distance measuring into one unit instead of two and is operated in the ultra-high-frequency band. As a compromise between civilian and military requirements, the FAA replaced the DME portion of its VOR facilities with the distance measuring components of TACAN. These stations are known as VORTAC stations. If a station has full TACAN equipment, both azimuth and distance measuring equipment, and also VOR, it is designated as VORTAC.

NDB and VOR systems are often located on airport airfields. The location of these systems on airport, known as TVORs, are significant to airport planners and designers, as the location of other facilities, such as large buildings, particularly constructed of metal, may adversely affect the performance of the navaid.

As illustrated in Fig. 3-12, TVORs should be located at least 500 ft from any runways and 250 ft from any taxiways. Any structures or trees should be located at least 1000 ft from the TVOR antenna. There should also be a clearance angle of at least 2.5° for any structures and 2.0° for any trees beyond 1000 ft, as illustrated in Fig. 3-13.

Airport traffic control

Air traffic control facilities provide the basis for communication with aircraft and the relay and clearance of flight plans for air traffic. There are three basic types of facilities: air route traffic control centre, airport traffic control tower and flight service station. The first attempt to set up rules for air traffic control was made by the International Commission for Air Navigation (ICAN), which was under the direction of the League of Nations. The procedures which the commission promulgated in July of 1922 were adopted by 14 countries. Although the United States was not a member of the League of Nations, and therefore did not officially adopt the rules, many of the procedures established by ICAN were used in the promulgation of air traffic procedures in the United States as well as in most regions of the world. Construction and operation of the airways system in the United States prior to 1926 were controlled by the military and by the Post Office Department. The formal entry of the federal government into the regulation of air traffic came with the passage of the Air Commerce Act of 1926 (Public Law 64-254). This act directed the Bureau of Air Commerce to establish, maintain, and operate lighted civil airways. At the present time the Federal Aviation Administration maintains and operates the airways system of the United States.

Air route traffic control centre (ARTCC)

There are several domestic air route traffic control centres that control the movement of aircraft along the airways. Each centre has control of a definite geographical area and is concerned primarily with the control of aircraft. At the boundary limit of the control area of the centre, aircraft is released either to an adjacent centre or to an airport control tower. Nowadays most of the aircraft separation is maintained by radar. Each ARTCC is broken down into sectors in order to increase efficiency of the personnel in the centre. Each sector are smaller geographical areas, air traffic is monitored in each sector by remote radar unit at the geographical location. In the process aircraft flight plan is transferred between the sectors within an air route traffic control centre and between the air traffic control centre when crossing the ARTCC boundary.

Airport traffic control tower

Airport control towers are the facilities that supervise, direct and monitor traffic within the airport area. The control tower provides a traffic control function for aircraft arriving or departing from an airport for 5 to 20km radius.

Some control tower have approach control facilities and associated airport surveillance radar (ASR) which guide aircraft to the airport from a number of specific positions, called “fixes” within approximately 40 km of airport. Aircraft are brought to this position by ARTCCs. It is often at these fixes; aircraft are held or “stacked” for landing during periods of heavy traffic.

Flight service station (FSS)

FSS which are nowadays fully automated, are located long the airways and at airports. Their main functions are

- Relay traffic control messages between en route aircraft and air route traffic control centre.
- Brief pilots, before flight and in flight, on weather, navigational aids, airports that are out of commission, and changes in procedure and new facilities.
- Disseminate weather information.
- Monitor navigation aids.

Bibliography

Chandra, S. (2008). *Railway engineering*. Oxford University Press, Inc..

Khanna, S. K., & Arora, M. G. (1971). *Airport Planning and Design*. Mom Chand.