

## LAND SURVEY-1

## LECTURE 1

### Introduction:

- Surveying is defined as taking a general view of, by observation and measurement determining the boundaries, size, position, quantity, condition, value etc. of land, estates, building, farms mines etc. and finally presenting the survey data in a suitable form . This covers the work of the valuation surveyor, the quantity surveyor, the building surveyor, the mining surveyor and so forth, as well as the land surveyor.
- Another school of thought define surveying as the act of making measurement of the relative position of natural and manmade features on earth s surface and the presentation of this information either graphically or numerically.

### The process of surveying is therefore in three stages namely:

#### (i) Taking a general view

This part of the definition is important as it indicates the need to obtain an overall picture of what is required before any type of survey work is undertaken. In land surveying, this is achieved during the reconnaissance study.

#### (ii) Observation and Measurement

This part of the definition denotes the next stage of any survey, which in land surveying constitutes the measurement to determine the relative position and sizes of natural and artificial features on the land.

#### (iii) Presentation of Data:

The data collected in any survey must be presented in a form which allows the information to be clearly interpreted and understood by others. This presentation may take the form of written report, bills of quantities, datasheets, drawings and in land surveying maps and plan showing the features on the land.

### Types of Surveying

On the basis of whether the curvature of the earth is taken into account or not, surveying can be divided into two main categories:

**Plane surveying:** is the type of surveying where the mean surface of the earth is considered as a plane. All angles are considered to be plane angles. For small areas less than 250 km<sup>2</sup> plane surveying can safely be used. For most engineering projects such as canal, railway, highway, building, pipeline, etc constructions, this type of surveying is used. It is worth noting that the difference between an arc distance of 18.5 km and the subtended chord lying in the earth s surface is 7mm. Also the sum of the angles of a plane triangle and the sum of the angles in a spherical triangle differ by 1 second for a triangle on the earth s surface having an area of 196 km<sup>2</sup>.

**Geodetic surveying:** is that branch of surveying, which takes into account the true shape of the earth (spheroid).

## **Classification of surveying**

### **Introduction**

For easy understanding of surveying and the various components of the subject, we need a deep understanding of the various ways of classifying it.

### **Objective**

To enable the students have understanding of the various ways of classifying surveying  
Classification Of Surveying

Surveying is classified based on various criteria including the instruments used, purpose, the area surveyed and the method used.

Classification on the Basis of Instruments Used.

Based on the instrument used; surveys can be classified into;

- i) Chain tape surveys
- ii) Compass surveys
- iii) Plane table surveys
- iv) Theodolite surveys

Classification based on the surface and the area

surveyed i) Land survey

Land surveys are done for objects on the surface of the earth. It can be subdivided into:

- (a) Topographic survey: This is for depicting the (hills, valleys, mountains, rivers, etc) and manmade features (roads, houses, settlements ) on the surface of the earth.
- (b) Cadastral survey is used to determining property boundaries including those of fields, houses, plots of land, etc.
- (c) Engineering survey is used to acquire the required data for the planning, design and Execution of engineering projects like roads, bridges, canals, dams, railways, buildings, etc.

(d) City surveys: The surveys involving the construction and development of towns including roads, drainage, water supply, sewage street network, etc, are generally referred to as city survey.

(2) Marine or Hydrographic Survey: Those are surveys of large water bodies for navigation, tidal monitoring, the construction of harbours etc.

(3) Astronomical Survey:

Astronomical survey uses the observations of the heavenly bodies (sun, moon, stars etc) to fix the absolute locations of places on the surface of the earth.

## LECTURE 2

### CLASSIFICATION ON THE BASIS OF PURPOSE

i) Engineering survey

ii) Control Survey:

Control survey uses geodetic methods to establish widely spaced vertical and horizontal control points.

iii) Geological Survey

Geological survey is used to determine the structure and arrangement of rock strata.

Generally, it enables to know the composition of the earth.

iv) Military or Defence Survey is carried out to map places of military and strategic importance

iv) Archeological survey is carried out to discover and map ancient/relies of antiquity. Classification Based On Instrument Used

i. Chain/Tape Survey: This is the simple method of taking the linear measurement using a chain or tape with no angular measurements made.

ii. Compass Survey: Here horizontal angular measurements are made using magnetic compass with the linear measurements made using the chain or tape.

iii. Plane table survey: This is a quick survey carried out in the field with the measurements and drawings made at the same time using a plane table.

iv. Leveling

This is the measurement and mapping of the relative heights of points on the earth's surface showing them in maps, plane and charts as vertical sections or with conventional symbols.

Vi. Theodolite Survey:

Theodolite survey takes vertical and horizontal angles in order to establish controls

### CLASSIFICATION BASED ON THE METHOD USED 1. Triangulation Survey

In order to make the survey, manageable, the area to be surveyed is first covered with series of triangles. Lines are first run round the perimeter of the plot, then the details

fixed in relation to the established lines. This process is called triangulation. The triangle is preferred as it is the only shape that can completely cover an irregularly shaped area with minimum space left.

ii. Traverse survey:

If the bearing and distance of a place of a known point is known: it is possible to establish the position of that point on the ground. From this point, the bearing and distances of other surrounding points may be established. In the process, positions of points linked with lines linking them emerge. The traversing is the process of establishing these lines, is called traversing, while the connecting lines joining two points on the ground. Joining two while bearing and distance is known as traverse. A traverse station is each of the points of the traverse, while the traverse leg is the straight line between consecutive stations. Traverses may either be open or closed.

**1. Closed Traverse :**

When a series of connected lines forms a closed circuit, i.e. when the finishing point coincides with the starting point of a survey, it is called as a closed traverse , here ABCDEA represents a closed traverse. (Fig 2.1 (a))

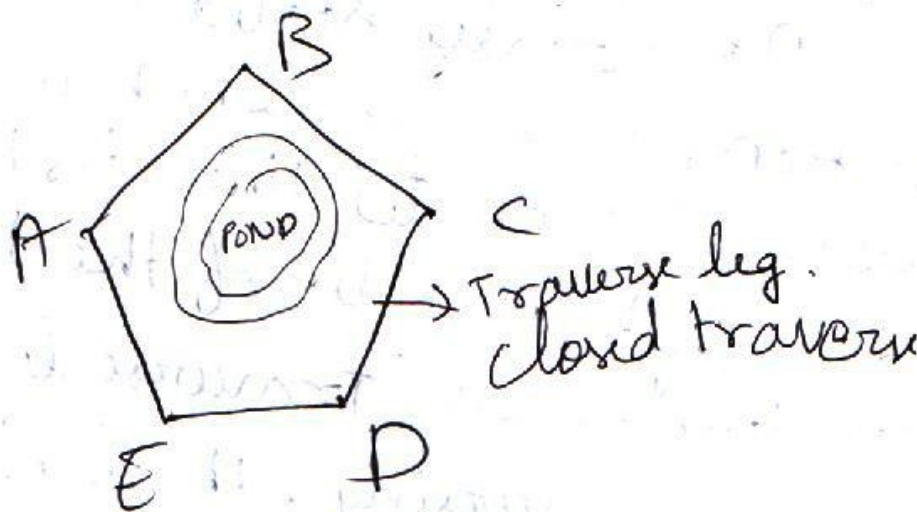

Fig 2.1 (a) Closed traverse is suitable for the survey of boundaries of ponds, forests etc.

**2. Open Traverse :**

When a sequence of connected lines extends along a general direction and does not return to the starting point, it is known as open traverse or (unclosed traverse). Here ABCDE represents an open traverse. Fig 2.2 (b)

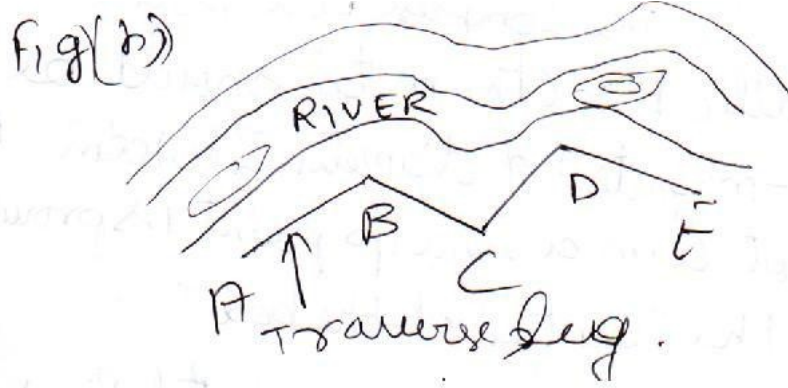

Fig 2.2 (b) Open traverse is suitable for the survey of roads, rivers etc.

## LECTURE 3

### CLASSIFICATION OF SURVEYORS

Surveying is made up of various specializations known as sectors or classes as shown below:

#### 1. General Practice Surveyors:

- Surveyors under this class are mostly concerned with valuation and investment. Valuation surveyors deal with property markets, land and property values, valuation procedures and property law. Investment surveyors help investors to get the best possible return from property.
- They handle a selection of properties for purchase or sale by pension funds, insurance companies, charities and other major investors. They also specialize in housing policy advice, housing development and management.

#### 2. Planning and Development Surveyors

- They are concerned with preparing planning applications and negotiating with local authorities planners to obtain planning permission.

#### 3. Building Surveyors

- Their work involves advising on the construction, maintenance, repair of all types of residential and commercial property.
- The analysis of building defects is an important part of a building surveyors discipline.

#### 4. The Quantity Surveyors

- They evaluate project cost and advice on alternative proposals. They also





ensure that each element of a project agrees with the cost plan allowance and that the overall project remains within budget.

#### **5. Rural Practice Surveyors:**

- Surveyors in rural practice advice land owners, farmers and others with interests in the country side.
- They are responsible for the management of country estates and farms, the planning and execution of development schemes for agriculture, forestation, recreation, sales of properties and live stock.

#### **6. Mineral Surveyors**

- They plan the development and future of mineral workings. They work with local authorities and the land owners on planning applications and appeals, mining laws and working rights, mining subsidence and damage, the environmental effects of land and deep underground mines.

#### **7. Land surveyors:**



- They measure land and its physical features accurately and record them in the form of a map or plan for the purpose of planning new building and by local authorities in managing roads, housing estates, and other facilities.
- They also undertake the positioning and monitoring for construction works.

## LECTURE 4 BRANCHES OF SURVEYING

### 1. Aerial Surveying

- Aerial surveys are undertaken by using photographs taken with special cameras mounted in an aircraft viewed in pairs. The photographs produce three-dimensional images of ground features from which maps or numerical data can be produced usually with the aid of stereo plotting machines and computers.



### 2. Hydrographic Surveying (Hydro-Survey)



- Hydro survey is undertaken to gather information in the marine environment such as mapping out the coast lines and sea bed in order to produce navigational charts.



- It is also used for off shore oil exploration and production, design, construction and maintenance of harbours, inland water routes, river and sea defence, pollution control and ocean studies.



### 3. Geodetic Survey:

- In geodetic survey, large areas of the earth surface are involved usually on national basis where survey stations are precisely located large distances apart. Account is taken of the curvature of the earth, hence it involves advanced

mathematical theory and precise measurements are required to be made.

- Geodetic survey stations can be used to map out entire continent, measure the size and shape of the earth or in carrying out scientific studies such as determination of the Earth's magnetic field and direction of continental drifts.

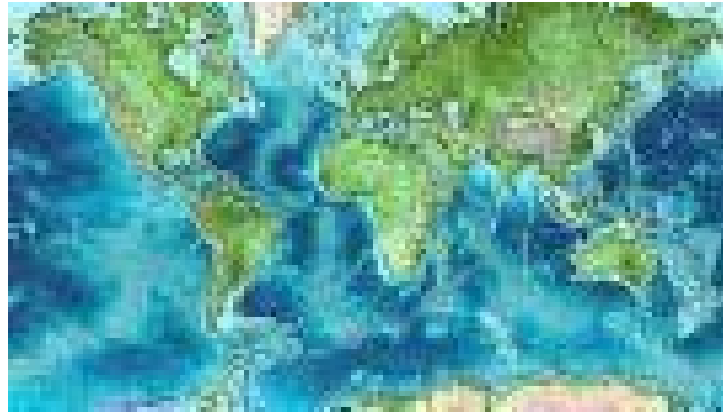

#### **4. Plane Surveying**

- In plane surveying relatively small areas are involved and the area under consideration is taken to be a horizontal plane. It is divided into three branches.
  - Cadastral surveying
  - Topographical surveying
  - Engineering surveying

#### **5. Cadastral surveying**

- These are surveys undertaken to define and record the boundary of properties, legislative area and even countries.
- It may be almost entirely topographical where features define boundaries with the topographical details appearing on ordinance survey maps.
- In the other hand, markers define boundaries, corner or line points and little account may be taken of the topographical features.

## 6. Topographical Survey

- These are surveys where the physical features on the earth are measured and maps/plans prepared to show their relative positions both horizontally and vertically.

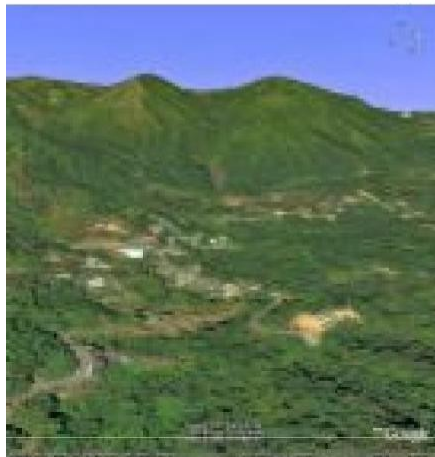

- The relative positions and shape of natural and man –made features over an area are established usually for the purpose of producing a map of the area or for establishing geographical information system.

## 8. Engineering Survey

- These are surveys undertaken to provide special information for construction of Civil Engineering and building projects.
- The survey supply details for a particular engineering schemes and could include setting out of the work on the ground and dimensional control on such schemes.



## LECTURE 5

### **Reconnaissance:**

- This is an exhaustive preliminary survey of the land to be surveyed. It may be either ground reconnaissance or aerial reconnaissance survey.
- Reconnaissance is made on arrival to site during which an overall picture or view of the area is obtained. The most suitable position of stations is selected, the purpose of the survey and the accuracy required will be drawn, and finally the method of observation will be established.

### **Objectives of reconnaissance**

1. To ascertain the possibility of building or constructing route or track through the area.
2. To choose the best one or more routes and record on a map
3. To estimate probable cost and draft a report.

The basic principles and process surveying

Introduction

So far , we have discussed the meaning, object and major classifications of surveying. Now let us move further to discuss the basic principles and process of surveying.

objectives.

- To enable students understand the basic principles of surveying.
- To expose the students to the process of surveying.

## LECTURE 6

### BASIC PRINCIPLES IN SURVEYING

#### PRINCIPLE OF WORKING FROM WHOLE TO PART

- It is a fundamental rule to always work from the whole to the part. This implies a precise control surveying as the first consideration followed by subsidiary detail surveying.
- This surveying principle involves laying down an overall system of stations whose positions are fixed to a fairly high degree of accuracy as control, and then the survey of details between the control points may be added on the frame by less elaborate methods.
- Once the overall size has been determined, the smaller areas can be surveyed in the knowledge that they must (and will if care is taken) put into the confines of the main overall frame.
- Errors which may inevitably arise are then contained within the framework of the control points and can be adjusted to it.

Surveying is based on simple fundamental principles which should be taken

into consideration to enable one get good results.

(a) Working from the whole to the part is achieved by covering the area to be surveyed with a number of spaced out control point called primary control points whose pointing have been determined with a high level of precision using sophisticated equipments. Based on these points as theoretic, a number of large triangles are drawn. Secondary control points are then established to fill the gaps with lesser precision than the primary control points. At a more detailed and less precise level, tertiary control points at closer intervals are finally established to fill in the smaller gaps. The main purpose of surveying from the whole to the part is to localize the errors as working the other way round would magnify the errors and introduce distortions in the survey. In partial terms, this principle involve covering the area to be surveyed with large triangles. These are further divided into smaller triangles and the process continues until the area has been sufficiently covered with small triangles to a level that allows detailed surveys to be made in a local level. Error is in the whole operation as the vertices of the large triangles are fixed using higher precision instruments.

(b) Using measurements from two control parts to fix other points. Given two points whose length and bearings have been accurately determined, a line can be drawn to join them hence surveying has control reference points. The locations of various other points and the lines joining them can be fixed by measurements made from these two points and the lines joining them. For an example, if A and B are the control points, the following operations can be performed to fix other points.

- i) Using points A and B as the centers, ascribe arcs and fix (where they intersect).
- ii) Draw a perpendicular from D along AB to a point C.



iii) To locate C, measure distance AB and use your protractor to equally measure angle ABC.

iv) To locate C the interior angles of triangle ABC can be measured. The lengths of the sides AC and BC can be calculated by solving the triangle.

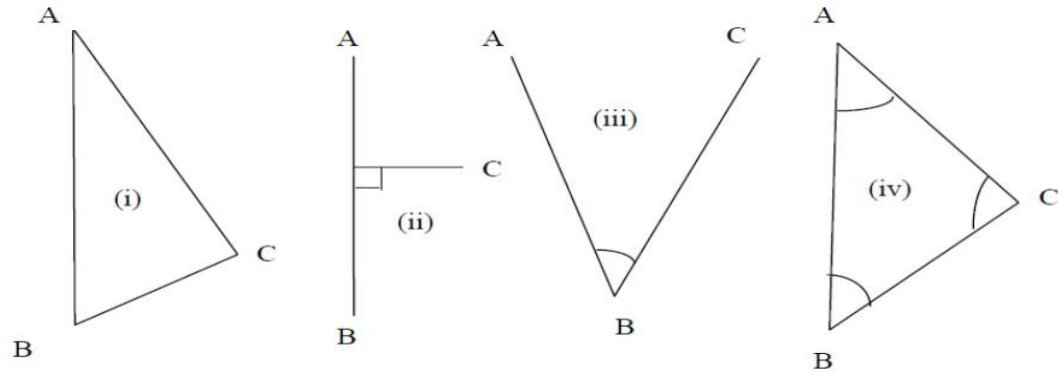

Fig. 6.1: Fixing the third points using two points

The process of surveying:

The survey process passes through 3 main phases – the reconnaissance, field work and measurements, and, the office work.

(a) Reconnaissance survey

This is a pre-field work and measurement phase. It requires taking an overall inspection of the area to be surveyed to obtain a general picture before commencement of any serious survey. Walking through the site enables one to understand the terrain and helps in determining the survey method to be adopted, and the scale to be used. The initial information obtained in this stage helps in the successful planning and execution of the survey.

(b) Field work and measurement:

This is the actual measurements in the field and the recordings in the field notebook. To get the best results in the field, the surveyor must be acquainted with the functions of the equipments and take good care of them.

(c) Office work: This is the post field work stage in which data collected and recordings in the field notebooks are decoded and used to prepare the charts, planes and maps for presentation to the clients and the target audience.

## LECTURE 7

### IMPORTANCE OF SCIENTIFIC HONESTY

- Honesty is essential in booking notes in the field and when plotting and computations in the office. There is nothing to be gained from cooking the survey or altering dimensions so that points will tie-in on the drawing. It is utterly unprofessional to betray such trust at each stage of the survey.
- This applies to the assistants equally as it does to the surveyor in charge. Assistants must also listen carefully to all instructions and carry them out to the later without questions.

### CHECK ON MEASUREMENTS

- The second principle is that; all survey work must be checked in such a way that an error will be apparent before the survey is completed.
- Concentration and care are necessary in order to ensure that all necessary measures are taken to the required standard of accuracy and that nothing is omitted. Hence they must be maintained in the field at all times.
- Surveyor on site should be checking the correctness of his own work and that of others which is based on his information.
- Check should be constantly arranged on all measurements wherever possible. Check measurements should be conducted to supplement errors on field. Pegs can be moved, sight rails altered etc.
- Survey records and computations such as field notes, level books, field books, setting out record books etc must be kept clean and complete with clear notes and diagrams so that the survey data can be clearly understood by others. Untidy and anonymous figures in the field books should be avoided.
- Like field work, computations should be carefully planned and carried out in a systemic manner and all field data should be properly prepared before calculations start. Where possible, standardized tables and forms should be used to simplify calculations. If the result of a computation has not been checked, it is considered unreliable and for this reason, frequent checks should be applied to every calculation procedure.
- As a check, the distances between stations are measured as they are plotted, to see that there is correspondence with the measured horizontal distance. Failure to match indicates an error in plotting or during the survey.
- If checks are not done on observations, expensive mistake may occur. It is always preferable to take a few more dimensions on site to ensure that the survey will resolve itself at the plotting stage.

## **ACCURACY AND PRECISION**

These terms are used frequently in engineering surveying both by manufacturers when quoting specifications for their equipments and on site by surveyors to describe results obtained from field work.

- Accuracy allows a certain amount of tolerance (either plus or minus) in a measurement, while;
- Precision demands exact measurement. Since there is no such things as an absolutely exact measurement, a set of observations that are closely grouped together having small deviations from the sample mean will have a small standard error and are said to be precise.

## **ECONOMY OF ACCURACY AND ITS INFLUENCE ON CHOICE OF EQUIPMENTS**

- Survey work is usually described as being to a certain standard of accuracy which in turn is suited to the work in hand. Bearing in mind the purpose for which the survey is being made, it is better to achieve a high degree of accuracy than to aim for precision (exactness) which if it were to be altered would depend not only on the instrument used but also on the care taken by the operator to ensure that his work was free from mistake.
- Always remember that, the greater the effort and time needed both in the field and in the office, the more expensive survey will be for the client. The standard accuracy attained in the field must be in keeping with the size of the ultimate drawings.
- The equipment selected should be appropriate to the test in hand. An important factor when selecting equipment is that the various instruments should produce roughly the same order of precision. A steel chain best at an accuracy of 1/500 to 1/1000 would be of little use for work requiring an accuracy of 1/1000. Similarly, the theodolite reading to one second would be pointless where a reading to one minute is sufficient.
- Having selected the equipment necessary, the work should be thoroughly checked and if found wanting should be adjusted, repaired or replaced or have allowance calculated for its deficiencies. This task will be less tedious if field equipment is regularly maintained.

## **Horizontal Distance Measurement**

One of the basic measurements in surveying is the determination of the distance between two points on the earth's surface for use in fixing position, set out and in scaling. Usually spatial distance is measured. In plane surveying, the distances measured are reduced to their equivalent horizontal distance either by the procedures used to make the

Under revision

measurement or by applying numerical corrections for the slope distance (spatial distance). The method to be employed in measuring distance depends on the required accuracy of the measurement, and this in turn depends on purpose for which the measurement is intended.

*Pacing:* – where approximate results are satisfactory, distance can be obtained by pacing (the number of paces can be counted by tally or pedometer registry attached to one leg). Average pace length has to be known by pacing a known distance several times and taking the average. It is used in reconnaissance surveys & in small scale mapping

*Odometer of a vehicle:* - based on diameter of tires (no of revolutions X wheel diameter); this method gives a fairly reliable result provided a check is done periodically on a known length. During each measurement a constant tyre pressure has to be maintained.

*Tachometry:* -distance can be measured indirectly by optical surveying instruments like theodolite. The method is quite rapid and sufficiently accurate for many types of surveying operations .

*Taping (chaining):* - this method involves direct measurement of distances with a tape or chain. Steel tapes are most commonly used .It is available in lengths varying from 15m to 100m. Formerly on surveys of ordinary precision, lengths of lines were measured with chains.

*Electronic Distance Measurement (EDM):* - are indirect distance measuring instruments that work using the invariant velocity of light or electromagnetic waves in vacuum. They have high degree of accuracy and are effectively used for long distances for modern surveying operations.

## LECTURE 8

### CHAIN SURVEYING

This is the simplest and oldest form of land surveying of an area using linear measurements only. It can be defined as the process of taking direct measurement, although not necessarily with a chain.

### EQUIPMENTS USED IN CHAIN SURVEYING

These equipments can be divided into three, namely

- (i) Those used for linear measurement. (Chain, steel band, linear tape)
- (ii) Those used for slope angle measurement and for measuring right angle (Eg. Abney level, clinometer, cross staff, optical squares)
- (iii) Other items (Ranging rods or poles, arrows, pegs etc).

#### 1. Chain:-

The chain is usually made of steel wire, and consists of long links joined by shorter links. It is designed for hard usage, and is sufficiently accurate for measuring the chain lines and offsets of small surveys.



Chains are made up of links which measure 200mm from centre to centre of each middle connecting ring and surveying brass handles are fitted at each end. Tally markers made of plastic or brass are attached at every whole metre position or at each tenth link. To avoid confusion in reading, chains are marked similarly from both end (E.g. Tally for 2m and 18m is the same) so that measurements may be commenced with either end of the chain

There are three different types of chains used in taking measurement namely:

#### i. Engineers chain



ii. Gunter s chain



iii Steel bands

**2 Steel Bands:**



This may be 30m, 50m or 100m long and 13mm wide. It has handles similar to those on the chain and is wound on a steel cross. It is more accurate but less robust than the chain. The operating tension and temperature for which it was graduated should be indicated on the band.

**3 Tapes:**

Tapes are used where greater accuracy of measurements are required, such as the setting out of buildings and roads. They are 15m or 30m long marked in metres, centimeter and millimeters. Tapes are classified into three types;



**i. Linen or Linen with steel wire woven into the fabric;**

These tapes are liable to stretch in use and should be frequently tested for length. They should never be used on work for which great accuracy is required.

**ii. Fibre Glass Tapes:** These are much stronger than lines and will not stretch in use.

**iii. Steel tapes:** These are much more accurate, and are usually used for setting out buildings and structural steel works. Steel tapes are available in various lengths up to 100m (20m and 30m being the most common) encased in steel or plastic boxes with a recessed winding lever or mounted on open frames with a folding winding lever.

**4. Arrows:**



Arrow consists of a piece of steel wire about 0.5m long, and are used for marking temporary stations. A piece of coloured cloth, white or red ribbon is usually attached or tied to the end of the arrow to be clearly seen on the field.

## 5. Pegs



Pegs are made of wood 50mm x 50mm and some convenient length. They are used for points which are required to be permanently marked, such as intersection points of survey lines. Pegs are driven with a mallet and nails are set in the tops.

## 6. Ranging Rod:



These are poles of circular section 2m, 2.5m or 3m long, painted with characteristic red and white bands which are usually 0.5m long and tipped with a pointed steel shoe to enable them to be driven into the ground. They are used in the measurement of lines with the tape, and for marking any points which need to be seen.

## 7. Optical Square:

This instrument is used for setting out lines at right angle to main chain line. It is used where greater accuracy is required. There are two types of optical square, one using two mirrors and the other a prism.





- The mirror method is constructed based on the fact that a ray of light is reflected from a mirror at the same angle as that at which it strikes the mirror.
- The prism square method is a simplified form of optical square consisting of a single prism. It is used in the same way as the mirror square, but is rather more accurate.

### 8 Cross Staff:



This consists of two pairs of vanes set at right angle to each other with a wide and narrow slit in each vane. The instrument is mounted upon a pole, so that when it is set up it is at normal eye level. It is also used for setting out lines at right angle to the main chain line.

### 9. Clinometer

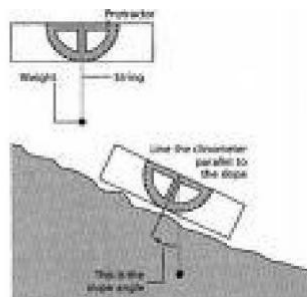

This instrument is used for measuring angles of ground slopes (slope angle). They are of several form, the common form is the **WATKING S CLINOMETER**, which consist of a small disc of about 60mm diameter. A weighted ring inside the disc can be made to hang free and by sighting across this graduated ring angle of slopes can be read off. It is less accurate than abney level.

## 9 Abney Level



This instrument is generally used to obtaine roughly the slope angle of the ground. It consists of a rectangular, telescopic tube (without lenses) about 125mm long with a graduated arc attached. A small bubble is fixed to the vernier arm, once the image of the bubble is seen reflected in the eyepiece the angle of the line of sight can be read off with the aid of the reading glass.

## LECTURE 9

### NECESSARY PRECAUTIONS IN USING CHAIN SURVEYING INSTRUMENTS

1. After use in wet weather, chains should be cleaned, and steel tapes should be dried and wiped with an oily rag.
2. A piece of colored cloth should be tied to arrow (or ribbon – attached) to enable them to be seen clearly on the field.
3. Ranging rods should be erected as vertical as possible at the exact station point.
4. The operating tension and temperature for which steel bands/tapes are graduated should be indicated.
5. Linen tapes should be frequently tested for length (standardized) and always after repairs.
6. Always keep tapes reeled up when not in use.

### GENERAL PROCEDURE IN MAKING A CHAIN SURVEY

1. **Reconnaissance:** Walk over the area to be surveyed and note the general layout, the position of features and the shape of the area.
2. **Choice of Stations:** Decide upon the framework to be used and drive in the station pegs to mark the stations selected.
3. **Station Marking:** Station marks, where possible should be tied - in to a permanent objects so that they may be easily replaced if moved or easily found during the survey. In soft ground wooden pegs may be used while rails may be used on roads or hard surfaces.
4. **Witnessing:** This consists of making a sketch of the immediate area around the station showing existing permanent features, the position of the stations and its description and designation. Measurements are then made from at least three surrounding features to the station point and recorded on the sketch.  
The aim of witnessing is to re-locate a station again at much later date even by others after a long interval.
5. **Offsetting:-** Offsets are usually taken perpendicular to chain lines in order to dodge obstacles on the chain line.
6. **Sketching** the layout on the last page of the chain book, together with the date and the name of the surveyor, the longest line of the survey is usually taken as the base line and is measured first.

## CRITERIA FOR SELECTING A SURVEY LINES/OFFSETS

During reconnaissance, the following points must be borne in mind as the criteria to provide the best arrangement of survey lines,

- a. **Few survey lines:** the number of survey lines should be kept to a minimum but must be sufficient for the survey to be plotted and checked.
- b. **Long base line:** A long line should be positioned right across the site to form a base on which to build the triangles.
- c. **Well conditioned triangle with angles greater than 30° and not exceeding 150°:** It is preferable that the arcs used for plotting should intersect as close as 90° in order to provide sharp definition of the stations point.
- d. **Check lines:** Every part of the survey should be provided with check lines that are positioned in such a way that they can be used for off- setting too, in order to save any unnecessary duplication of lines.
- e. Obstacles such as steep slopes and rough ground should be avoided as far as possible.
- f. **Short offsets to survey lines (close feature preferably 2m) should be selected:** So that measuring operated by one person can be used instead of tape which needs two people.
- g. Stations should be positioned on the extension of a check line or triangle. Such points can be plotted without the need for intersecting arcs.

Ranging:

Ranging involves placing ranging poles along the route to be measures so as to get a straight line. The poles are used to mark the stations and in between the stations.

## LECTURE 10

### ERRORS IN SURVEYING

- Surveying is a process that involves observations and measurements with a wide range of electronic, optical and mechanical equipment some of which are very sophisticated.
- Despite the best equipments and methods used, it is still impossible to take observations that are completely free of small variations caused by errors which must be guided against or their effects corrected.

### TYPES OF ERRORS

#### 1. Gross Errors

- These are referred to mistakes or blunders by either the surveyor or his assistants due to carelessness or incompetence.
- On construction sites, mistakes are frequently made by in – experienced Engineers or surveyors who are unfamiliar with the equipment and method they are using.
- These types of errors include miscounting the number of tapes length, wrong booking, sighting wrong target, measuring anticlockwise reading, turning instruments incorrectly, displacement of arrows or station marks etc.
- Gross errors can occur at any stage of survey when observing, booking, computing or plotting and they would have a damaging effect on the results if left uncorrected.
- Gross errors can be eliminated only by careful methods of observing booking and constantly checking both operations.

#### 2. Systematic or Cumulative Errors

- These errors are cumulative in effect and are caused by badly adjusted instrument and the physical condition at the time of measurement must be considered in this respect. Expansion of steel, frequently changes in electromagnetic distance (EDM) measuring instrument, etc are just some of these errors.
- Systematic errors have the same magnitude and sign in a series of measurements that are repeated under the same condition, thus contributing negatively or positively to the reading hence, makes the readings shorter or longer.

- This type of error can be eliminated from a measurement using corrections (e.g. effect of tension and temperature on steel tape).
- Another method of removing systematic errors is to calibrate the observing equipment and quantify the error allowing corrections to be made to further observations.
- Observational procedures by re-measuring the quantity with an entirely different method using different instrument can also be used to eliminate the effect of systematic errors.

### **3. Random or Compensating Errors**

- Although every precaution may be taken certain unavoidable errors always exist in any measurement caused usually by human limitation in reading/handling of instruments.
- Random errors cannot be removed from observation but methods can be adopted to ensure that they are kept within acceptable limits.
- In order to analyze random errors or variable, statistical principles must be used and in surveying their effects may be reduced by increasing the number of observations and finding their mean. It is therefore important to assume those random variables are normally distributed.

## LECTURE 11

### Corrections to Linear Measurement and their Application: -

The following corrections are to be applied to the linear measurements with a chain or a tape where such accuracy is required.

- (i) Pull correction,
- (ii) Temperature correction
- (iii) Standard length correction
- (iv) Sag correction
- (v) Slope correction
- (vi) Mean sea level correction.

#### Pull Correction: -

A chain or tape of nominal length  $L$  having cross sectional area of the link or that of a tape, as the case may be, equal to  $A$  and standardized under a pull  $P_s$  is employed to measure a length at a pull  $P_f$ . If Young's modulus of elasticity of the material is  $E$  the extension of its length is  $= \frac{(P_f - P_s)L}{AE}$ .

The recorded length is less than the actual by this extension. The error is here, -ve, the actual length is obtained by adding the extension to  $L$ . the correction is +ve. If  $P_f$  is less than  $P_s$  the error will be +ve and correction -ve.

#### Temperature Correction: -

A chain or a tape of nominal length  $L$  standardized at temperature  $T_s$  and having cross sectional area,  $A$  is employed to measured length at temperature  $T_f$ ,  $\alpha$  being the coefficient of linear expansion of the material of the chain or tape per unit rise of temperature, the extension  $= \alpha(T_f - T_s)L$ .

If  $T_f$  is more than  $T_s$ , recorded length is less than the actual by the amount of extension. The error is -ve and the correction to the length  $L$  is +ve by the amount of extension. If the field temperature  $T_f$  is less than  $T_s$  the error is +ve and the corrections is -ve.

### Sag Correction :-

In case of suspended measurement across a span L the chain or tape sag to take the form of curve known as catenary.

$$(wl) \quad \frac{W}{24P^2} \quad \frac{IC_{sa}}{24P^2} \quad l_1 =$$

Where w= weight of the tape per metre length

W= Total weight of the tape

P=pull applied (in N)

$l_1$  = The length of tape suspended between two supports

$l$  = length of the tape =  $n l_1$  (in m)

Sag correction is always negative.



## LECTURE 12

### TRIANGULATION

Because, at one time, it was easier to measure angles than it was distance, triangulation was the preferred method of establishing the position of control points.

Many countries used triangulation as the basis of their national mapping system. The procedure was generally to establish primary triangulation networks, with triangles having sides ranging from 30 to 50 km in length. The primary trig points were fixed at the corners of these triangles and the sum of the measured angles was correct to  $\pm 3$ . These points were usually established on the tops of mountains to afford long, uninterrupted sight lines. The primary network was then densified with points at closer intervals connected into the primary triangles. This secondary network had sides of 10–20 km with a reduction in observational accuracy. Finally, a third order net, adjusted to the secondary control, was established at 3–5-km intervals and fourth-order points fixed by intersection. Figure 12.2 illustrates such a triangulation system established by the Ordnance Survey of Great Britain and used as control for the production of national maps. The base line and check base line would be measured by invar tapes in catenary and connected into the triangulation by angular extension procedures. This approach is classical triangulation, which is now obsolete. The more modern approach would be to measure the base lines with EDM equipment and to include many more measured lines in the network, to afford greater control of scale error. Although the areas involved in construction are relatively small compared with national surveys (resulting in the term microtriangulation) the accuracy required in establishing the control surveys is frequently of a very high order, e.g. long tunnels or dam deformation measurements.

Fig. 12.1

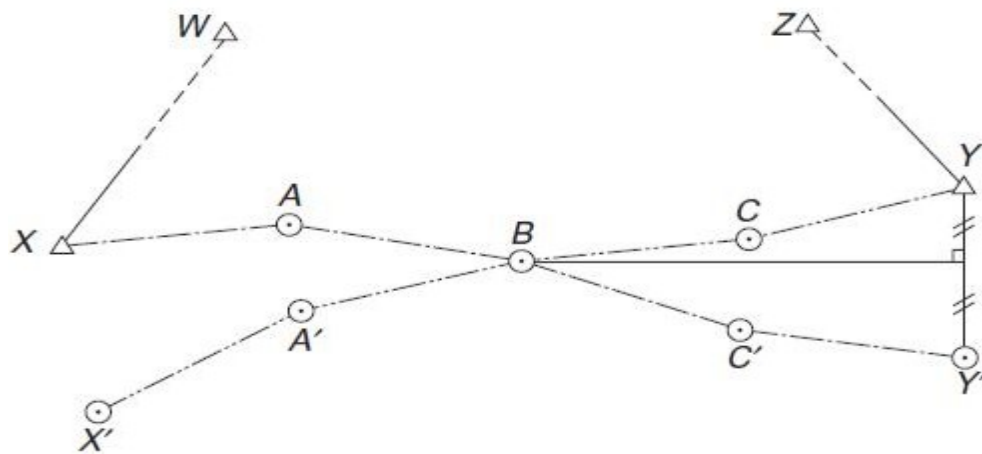

Fig. 12.1

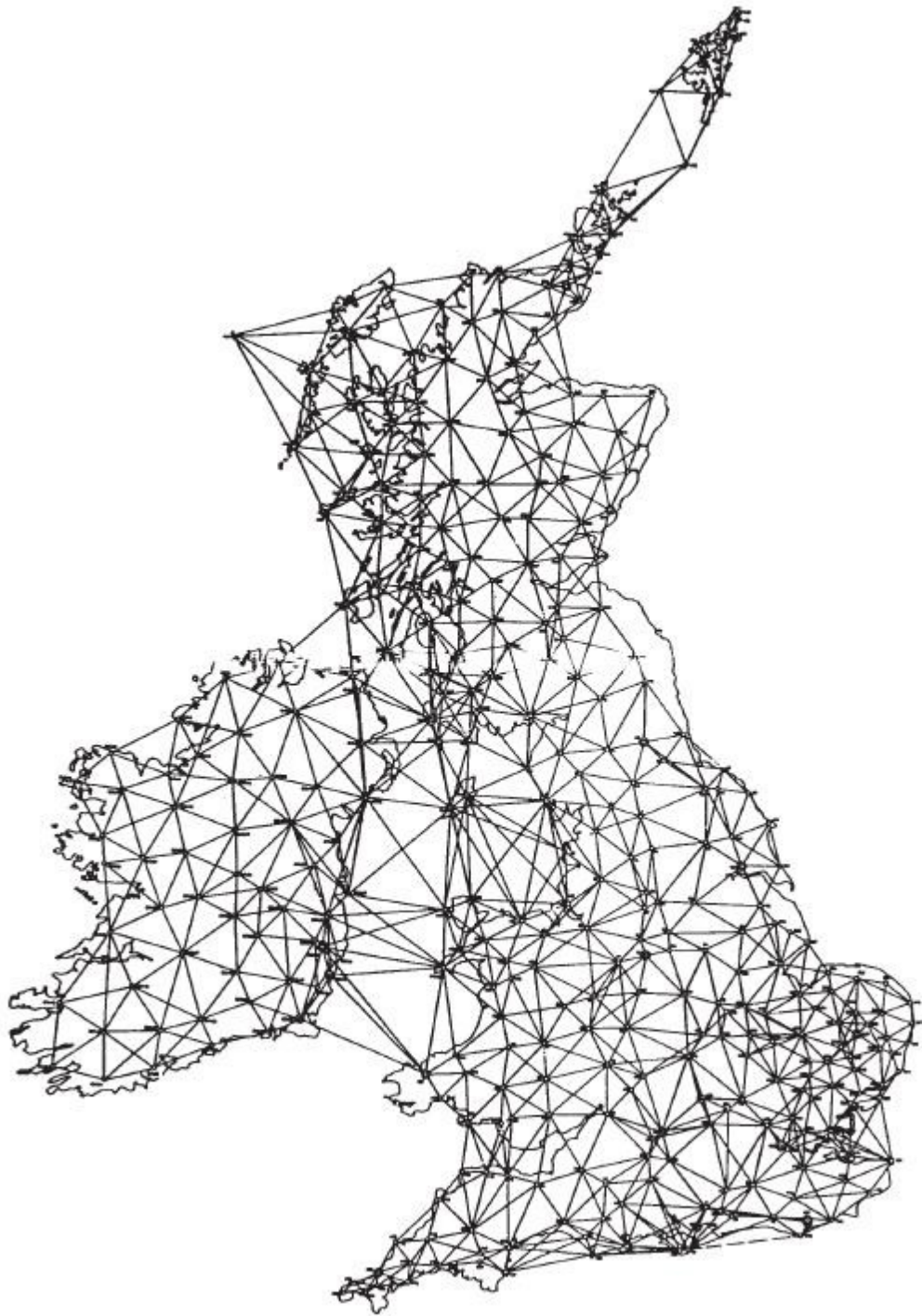

Figure 12.2

The principles of the method are illustrated by the typical basic figures shown in *Figure 12.3*. If all the angles are measured, then the scale of the network is obtained by the measurement of one side only, i.e. the base line. Any error, therefore, in the measurement of the base line will result in scale error throughout the network. Thus, in order to control this error, check base lines should be measured at intervals. The scale

error is defined as the difference between the measured and computed check base. Using the base line and adjusted angles the remaining sides of the triangles may be found and subsequently the coordinates of the control stations. Triangulation is best suited to open, hilly country, affording long sights well clear of intervening terrain. In urban areas, roof-top triangulation is used, in which the control stations are situated on the roofs of accessible buildings.

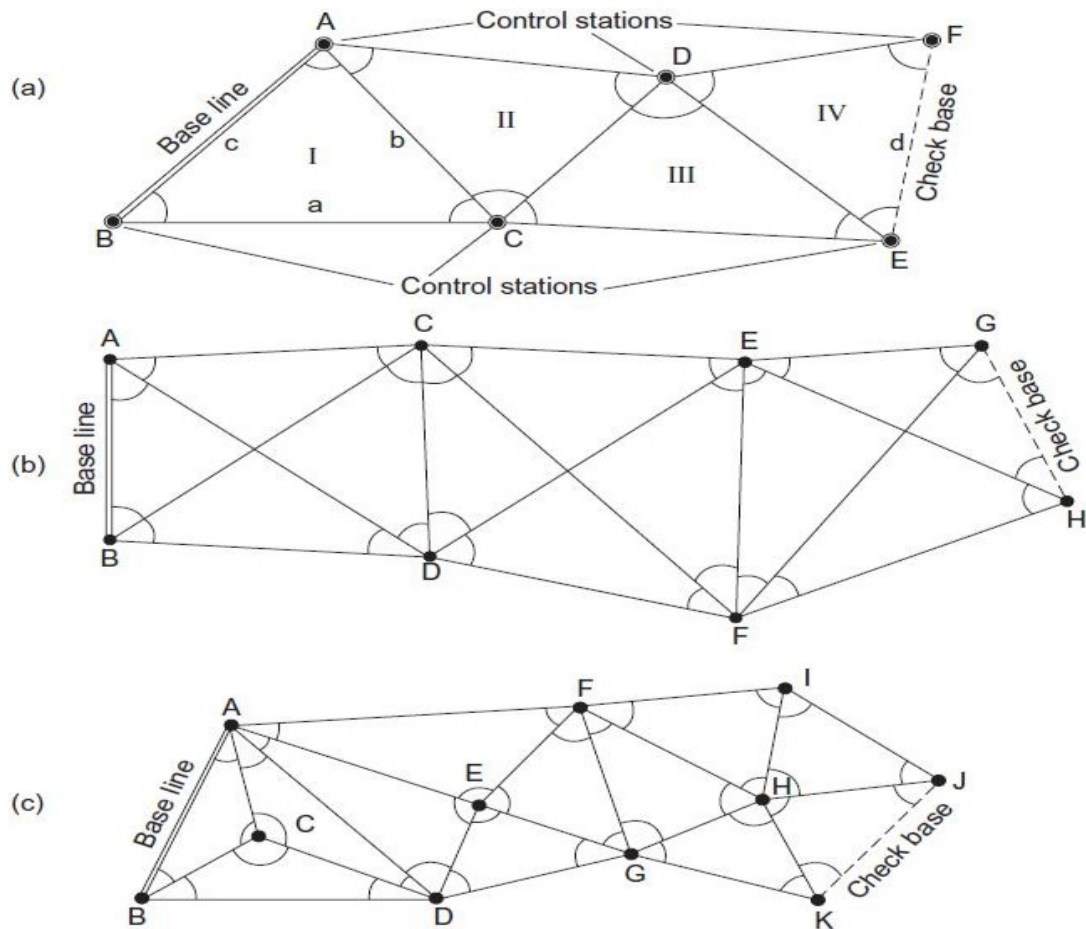

Fig. 12.3 (a) Chain of simple triangles, (b) braced quadrilaterals and (c) polygons with central points.

## LECTURE 13

### **General procedure:**

- (1) Reconnaissance of the area, to ensure the best possible positions for stations and base lines.
- (2) Construction of the stations.
- (3) Consideration of the type of target and instrument to be used and also the method of observation.  
All of these depend on the precision required and the length of sights involved.
- (4) Observation of angles and base-line measurements.
- (5) Computation: base line reduction, station and figural adjustment, coordinates of stations by direct methods.

A general introduction to triangulation has been presented, aspects of which will now be dealt with in detail.

(1) Reconnaissance is the most important aspect of any well-designed surveying project. Its main function is to ensure the best positions for the survey stations commensurate with well-conditioned figures, ease of access to the stations and economy of observation. A careful study of all existing maps or plans of the area is essential. The best position for the survey stations can be drawn on the plan and the overall shape of the network studied. While chains of single triangles are the most economic to observe, braced quadrilaterals provide many more conditions of adjustment and are at their strongest when square shaped. Using the contours of the plan, profiles between stations can be plotted to ensure intervisibility. Stereo-pairs of aerial photographs, giving a three-dimensional view of the terrain, are useful in this respect. Whilst every attempt should be made to ensure that there are no angles less than  $25^\circ$ , if a small angle cannot be avoided it should be situated opposite a side which does not enter into the scale computation. When the paper triangulation is complete, the area should then be visited and the site of every station carefully investigated. With the aid of binoculars, intervisibility between stations should be checked and ground-grazing rays avoided. Since the advent of EDM, base-line sitting is not so critical. Soil conditions should be studied to ensure that the ground is satisfactory for the construction of long-term survey stations. Finally, whilst the strength of the network is a function of its shape, the purpose of the survey stations should not be forgotten and their position located accordingly.

(2) Stations must be constructed for long-term stability. A complete referencing of the station should then be carried out in order to ensure its location at a future date.

(3) As already stated, the type of target used will depend on the length of sight involved and the accuracy required for highly precise networks, the observations may be carried out at night when refraction is minimal. In such a case, signal lamps would be the only type of target to use. For short sights it may be possible to use the precise targets shown in *Figure 13.1*. Whatever form the target takes, the essential considerations are that it should be capable of being accurately centred over the survey point and afford the necessary size and shape for accurate bisection at the observation distances used.

(4) In triangulation the method of directions would inevitably be used and the horizon closed. An appropriate number of sets would be taken on each face. The base line and

check base would most certainly be measured by EDM, with all the necessary corrections made to ensure high accuracy.

(5) Since the use of computers is now well established, there is no reason why a least squares adjustment using the standard variation of coordinates method should not be carried out. Alternatively the angles may be balanced by simpler, less rigorous methods known as equal shifts. On completion, the sides may be computed using the sine rule and finally the coordinates of each survey point obtained. If the survey is to be connected to the national mapping system of the country, then all the baseline measurements must be reduced to MSL and multiplied by the local scale factor. As many of the national survey points as possible should be included in the scheme.

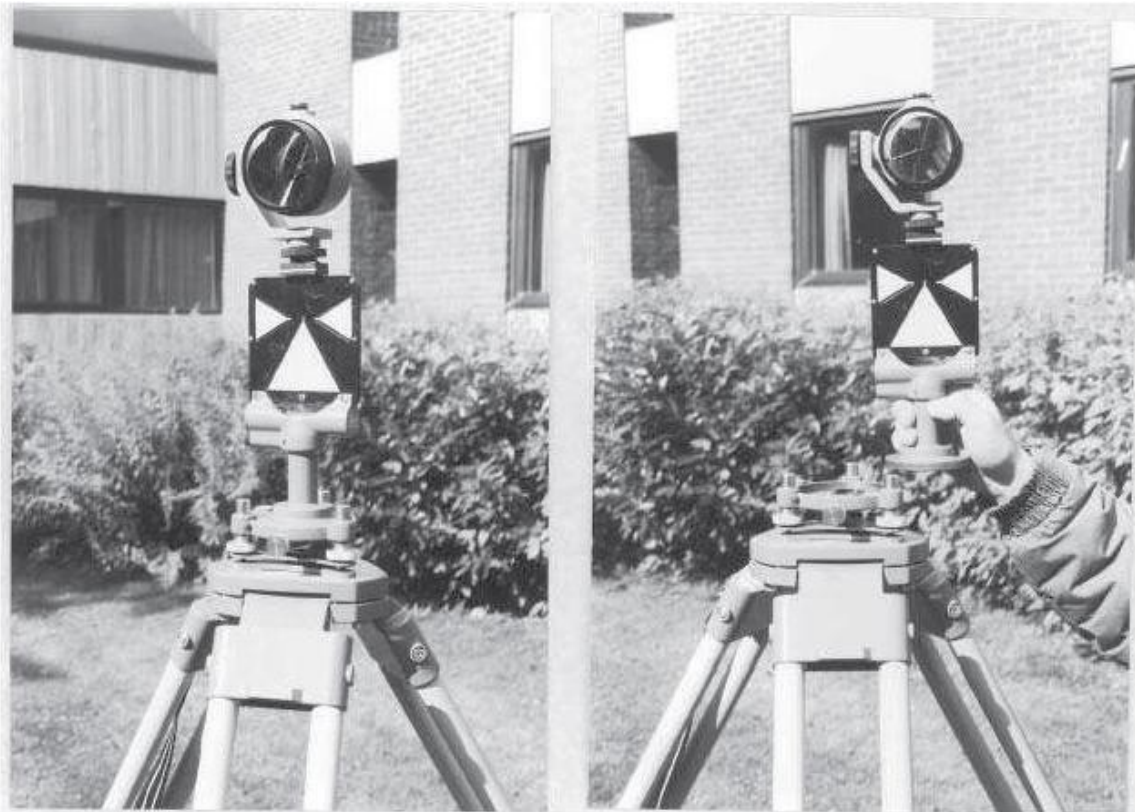

*Figure 13.1.* Interchangeable target and tribrach

## LECTURE 14

### **Overcoming obstacles during chaining:**

Agor (1993) classified the various types of obstacles encountered in the course of chaining into three

- Obstacles which obstruct ranging but not chaining
- Obstacles which obstruct chaining but not ranging
- Obstacle which obstruct both ranging and chaining

### **Obstacles that obstruct ranging but not chaining**

Such a problem arises when a rising ground or a jungle area interrupts the chain line. Here the end stations are not intervisible.

There may be two cases :-

#### **Case I :**

The end stations may be visible from some intermediate points on the rising ground. In this case, reciprocal ranging is resorted to and the chaining is done by the stepping method.

#### **Case II :**

The end stations are not visible from intermediate points when a jungle area comes across the chain line. In this case the obstacle may be crossed over using a random line as explained below :

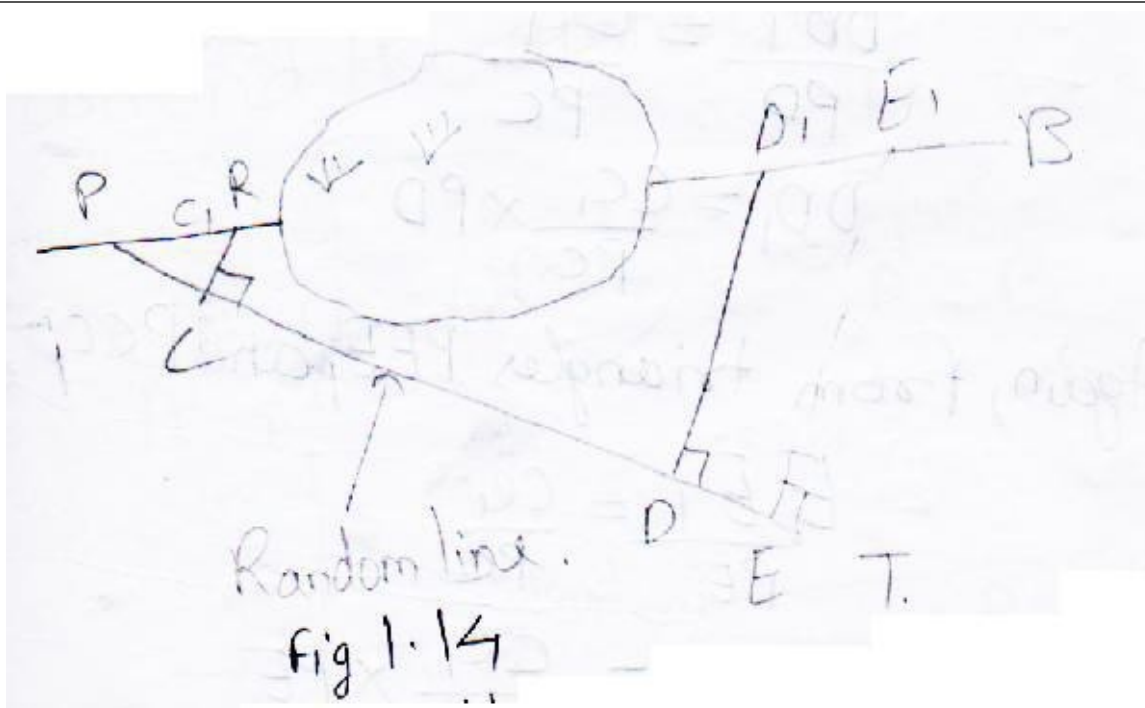

Fig 14.1 (1.14)

Let AB be the actual chain line which can be ranged and extended because of interruption by a jungle. Let the chain line be extended up to R. A point P is selected on the chain line and a random line PT is taken in a suitable direction. Points C, D and E are selected on the random line and perpendiculars are projected from them. The perpendicular at C meets the chain line at C1.

Theoretically, the perpendiculars at 'D' and 'E' will meet the chain line at D1 and E1. Now the distances PC, PD, PE and CC1 are measured (Fig 14.1(1.14)) from triangles PDD1 and PCC1.

$$\frac{DD_1}{PD} = \frac{CC_1}{PC}$$

$$DD_1 = \frac{CC_1}{PC} \times PD \quad (1)$$

Again, from triangles PEE1 and PCC1 –

$$\frac{EE_1}{PE} = \frac{CC_1}{PC}$$

$$EE_1 = \frac{CC}{PC_1} \times PE \quad (2)$$

From (1) and (2), the lengths DD<sub>1</sub> and EE<sub>1</sub> are calculated. These calculated distances are measured along the perpendiculars at 'D' and 'E'. Points D<sub>1</sub> and E<sub>1</sub> should lie in the chain line AB, which can be extended accordingly.

$$\text{Distance } PE_1 = \sqrt{PE^2 + EE_1^2}$$

### Obstacles which obstruct chaining but not ranging:

Water bodies like lakes, ponds and rivers are typical examples of obstacles in this category. It is possible to chain around these obstacles by using the following methods.

i. By constructing rectangles: Chaining had reached A and encountered an obstacle. To get to B, mark A and B with an arrow. Set of perpendiculars AC and BD high enough to clear the obstacles. Join and measure DC which now equals AB. This allows chaining to continue from B.

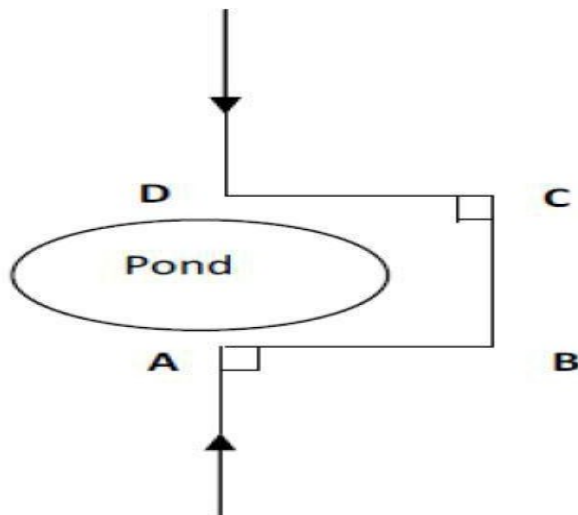

ii. By constructing similar triangles:

To continue chaining from B, fix a point C away from the obstacle. Range a pole at D to align with AC hence AC = CD. In line with BC range another point E in line with BC. Hence BC = CE.

Measure ED which equals AB hence chaining can continue from B.



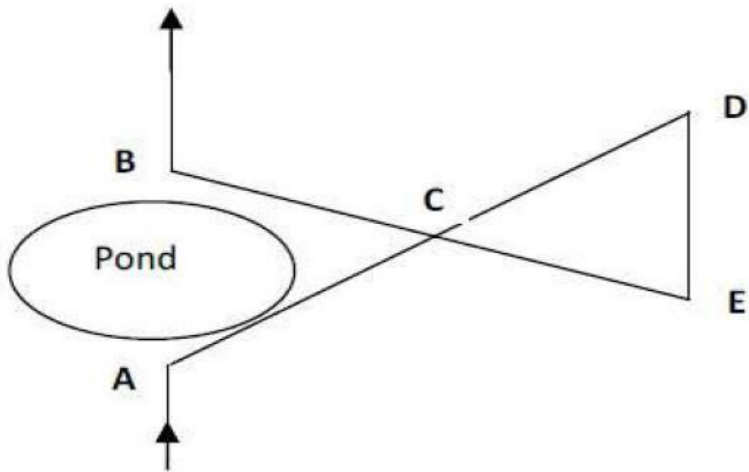

Obstacle which obstruct both ranging and chaining

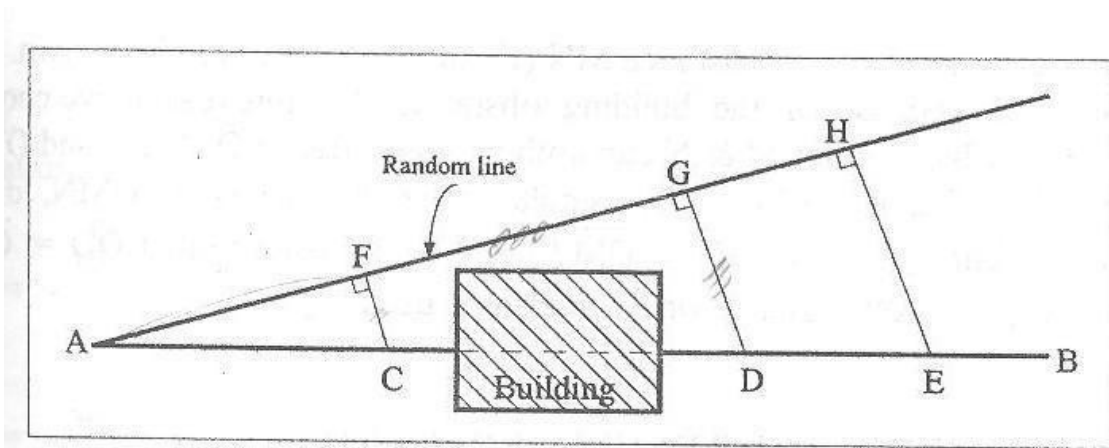

$$GD = (FC \times GA) / FA$$

$$HE = (FC \times HA) / FA$$

## LECTURE 15 COMPASS SURVEYING

### Introduction:

Another type of survey instrument that forms the subject of this section is the compass. Here, we will explain the meaning, types of compass survey and also introduce and discuss the concept of bearing.

### Objectives

- To introduce the students to the meaning and types of compass survey
- To enable students understand the concept of bearing.

### Meaning and types of compass survey

In compass survey, the direction of the survey line is measured by the use of a magnetic compass while the lengths are by chaining or taping. Where the area to be surveyed is comparatively large, the compass survey is preferred, whereas if the area is small in extent and a high degree of accuracy is desired, then chain survey is adopted. However, where the compass survey is used, care must be taken to make sure that magnetic disturbances are not present. The two major primary types of survey compass are: the prismatic compass and surveyors compass



Compass surveys are mainly used for the rapid filling of the detail in larger surveys and for explanatory works. It does not provide a very accurate determination of the bearing of a line as the compass needle aligns itself to the earth's magnetic field which does not provide a constant reference point.

## LECTURE 16

### THE PRISMATIC COMPASS



This is an instrument used for the measurement of magnetic bearings. It is small and portable usually carried on the hand. This Prismatic Compass is one of the two main kinds of magnetic compasses included in the collection for the purpose of measuring magnetic bearings, with the other being the Surveyor's Compass. The main difference between the two instruments is that the surveyor's compass is usually larger and more accurate instrument, and is generally used on a stand or tripod.

- The prismatic compass on the other hand is often a small instrument which is held in the hand for observing, and is therefore employed on the rougher classes of work. The graduations on this prismatic compass are situated on a light aluminum ring fastened to the needle, and the zero of the graduations coincides with the south point of the needle. The graduations therefore remain stationary with the needle, and the index turns with the sighting vanes. Since the circle is read at the observer's (rather than the target's) end, the graduations run clockwise from the south end of the needle ( $0^{\circ}$  to  $360^{\circ}$ ), whereas in the surveyor's compass, the graduations run anti-clockwise from north.
- The prismatic attachment consists of a  $45^{\circ}$  reflecting prism with the eye and reading faces made slightly convex so as to magnify the image of the graduations. The prism is carried on a mounting which can be moved up and down between slides fixed on the outside of the case.
  - The purpose of this up-and-down movement is to provide an adjustment for focusing. The image of the graduations is seen through a small circular aperture in the prism mounting, and immediately above this aperture is a small V cut on

top of the mounting, over which the vertical wire in the front vane may be viewed. Using the V cut, the vertical wire and the station whose bearing is required are viewed in one line, the bearing is directly read off the graduated arc at the point immediately underneath the vertical wire.

- The mirror located in front of the forward vane slides up and down the vane, and is hinged to fold flat over it or to rest inclined at any angle with it. This mirror is used for solar observations, or for viewing any very high object, and is not a normal fitting to a compass. The two circular discs in front of the back vane are dark glasses which can be swung in front of the vane when solar observations are being taken.

## COMPONENTS OF A PRISMATIC COMPASS

Prismatic compass consists of a non-magnetic metal case with a glass top and contain the following:

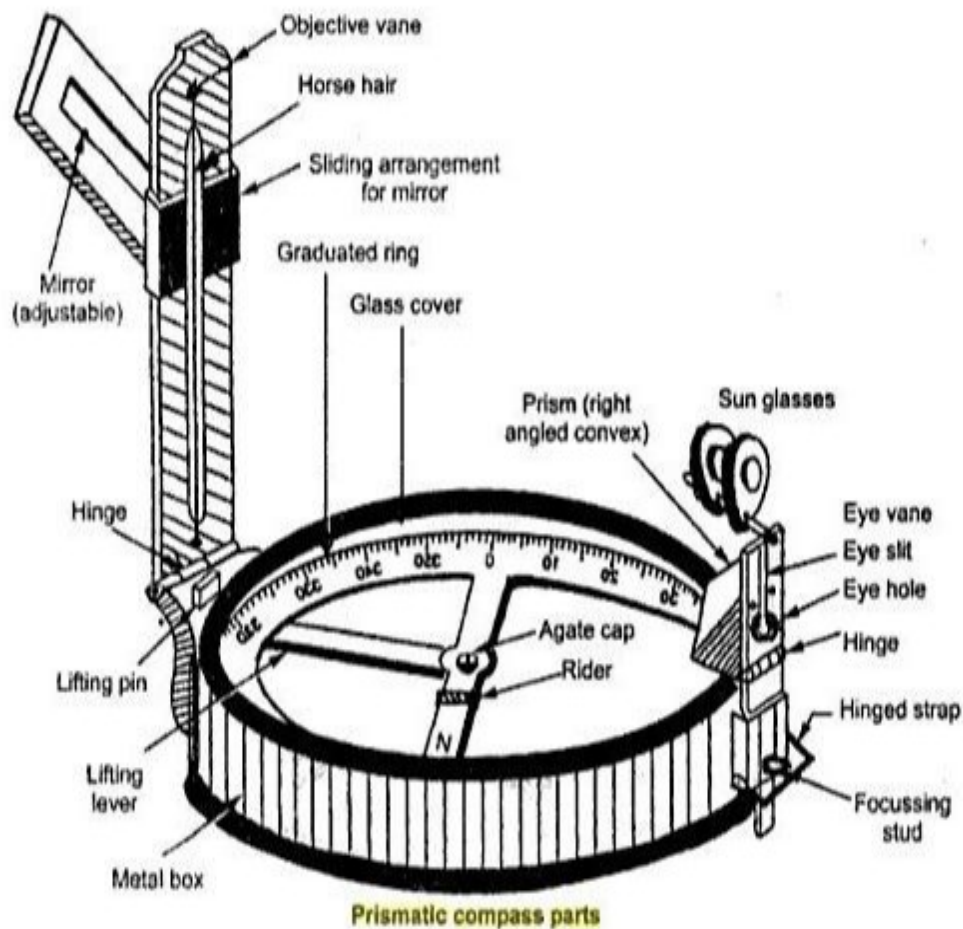

Elements of prismatic compass

- **Cylindrical metal box:** Cylindrical metal box is having diameter of 8 to 12 cm. It protects the compass and forms entire casing or body of the compass. It protects the compass from dust, rain etc.

- **Pivot:** pivot is provided at the center of the compass and supports freely suspended magnetic needle over it.
- **lifting pin and lifting lever:** a lifting pin is provided just below the sight vane. When the sight vane is folded, it presses the lifting pin. The lifting pin with the help of lifting lever then lifts the magnetic needle out of pivot point to prevent damage to the pivot head.
- **Magnetic needle:** Magnetic needle is the heart of the instrument. This needle measures angle of a line from magnetic meridian as the needle always remains pointed towards north south pole at two ends of the needle when freely suspended on any support.
- **Graduated circle or ring:** This is an aluminum graduated ring marked with 0° to 360° to measures all possible bearings of lines, and attached with the magnetic needle. The ring is graduated to half a degree.
- **Prism :** prism is used to read graduations on ring and to take exact reading by compass. It is placed exactly opposite to object vane. The prism hole is protected by prism cap to protect it from dust and moisture.
- **Object vane:** object vane is diametrically opposite to the prism and eye vane. The object vane is carrying a horse hair or black thin wire to sight object in line with eye sight.
- **Eye vane:** Eye vane is a fine slit provided with the eye hole at bottom to bisect the object from slit.
- **Glass cover:** its covers the instrument box from the top such that needle and graduated ring is seen from the top.
- **Sun glasses:** These are used when some luminous objects are to be bisected.
- **Reflecting mirror:** It is used to get image of an object located above or below the instrument level while bisection. It is placed on the object vane.
- **Spring brake or brake pin:** to damp the oscillation of the needle before taking a reading and to bring it to rest quickly, the light spring brake attached to the box is brought in contact with the edge of the ring by gently pressing inward the brake pin

## LECTURE 17

### Temporary adjustment of prismatic compass

- The following procedure should be adopted after fixing the prismatic compass on the tripod for measuring the bearing of a line.
- **Centering:** Centering is the operation in which compass is kept exactly over the station from where the bearing is to be determined. The Centering is checked by dropping a small pebble from the underside of the compass. If the pebble falls on the top of the peg then the Centering is correct, if not then the Centering is corrected by adjusting the legs of the tripod.
- **Levelling:** Levelling of the compass is done with the aim to freely swing the graduated circular ring of the prismatic compass. The ball and socket arrangement on the tripod will help to achieve a proper level of the compass. This can be checked by rolling round pencil on glass cover.
- **Focusing:** the prism is moved up or down in its slide till the graduations on the aluminium ring are seen clear, sharp and perfect focus. The position of the prism will depend upon the vision of the observer.

### OPERATION PROCEDURE

- Remove the corner and open out the prism and window, holding the compass as level as possible.
- Then focus the prism by raising or lowering its case until the divisions appear sharp and clear. If necessary with the needle on to its pivot.
- Holding the compass box with the thumb under the prism and the forefinger near the stud, sight through the objector station lowering the eye to read the required bearing as soon as the needle comes to rest naturally.
- The bearing read will be a forward bearing and normally a "whole circle" bearing clockwise angle between  $0^{\circ}$  to  $360^{\circ}$ .

## LECTURE 18

### VARIATION IN DECLINATION

The position of the magnetic poles is not fixed and the North magnetic pole tends to wander more than the south causing alterations in the positions of the isogonic lines from time to time. The angle of declination at any point is therefore not constant subject to the following variations;

**1. Secular Variation:**

This causes the largest variation in magnetic declination. It is a slow continuous swing with a cycle of about 400 to 500 years. Because of this large movement, the date, the declination and the approximate rate of annual change should be given for any magnetic orientation of survey.

**2. Diurnal Variation:**

This is a swing of the compass needle about its mean daily position.

**3. Periodic Variation:**

This is a minor variation of the magnetic meridian during the week, a lunar month, year, eleven years, etc.

**4. Irregular Variation:** These are caused by magnetic storms which can produce sudden variations of the magnetic meridian.

### Magnetic Bearing

The magnetic bearing of a survey line is the angle between the direction of the line and the direction of the magnetic meridian at the beginning of the line.

### Magnetic Meridian

- The magnetic meridian at any place is the direction obtained by observing the position of a freely supported magnetized needle when it comes to rest uninfluenced by local attracting forces.
- Magnetic meridians run roughly north –south and follow the varying trend of the earth's magnetic field. The direction of a magnetic meridian does not coincide with the true or geographical meridian which gives the direction of the true North pole except in certain places.

### Angle of Declination:

It is defined as the angle between the direction of the magnetic meridian and the true meridian at any point.

## LECTURE 19

### Surveyor's Compass:

Similar to the prismatic compass but with few modifications, the surveyor's compass is an old form of compass used by surveyors. It is used to determine the magnetic bearing of a given line and is usually used in connection with the chain or compass survey.



### Bearing

The bearing is the angular direction measured clockwise starting from North with reference to the observer. The reference North may be true or magnetic. While the true bearing is the angular direction measured in a place with the direction of true or geographical north; the magnetic bearing is the angle which it makes with the direction of Magnetic North measured in the clockwise direction.



## LECTURE 20

### Back and Fore bearing:

#### Introduction:

In this section, we will examine the back and fore bearing; and the steps to be taken when traversing with compass survey.

Back and fore bearing

Fore bearing is the compass bearing of a place taken from a station to the other in the direction that the survey is being carried out. The back bearing in the other hand is the bearing in the opposite direction i.e. the bearing taken backwards from the next station to its preceding station that the fore bearing was taken. The difference between BB and FB is always 180°.

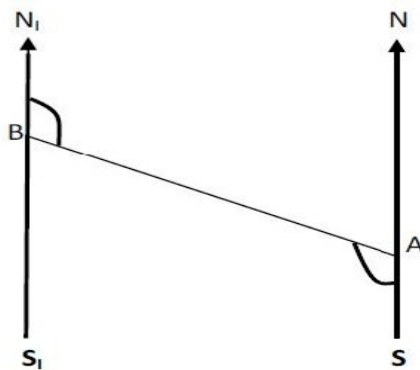

Back and fore bearing

If B is sighted from an observer at A, and the NS and N<sub>1</sub>S<sub>1</sub> are the magnetic NS lines, then Forward bearing (FB) =  $\angle N A S + \angle S A B$

Back bearing BA =  $\angle N_1 B A$

$\therefore$  Back Bearing BA = Forward Bearing AB - 180°

If the observer relocates to B and observes B, then forward bearing (FB) BA =  $\angle N_1 B A$  and back bearing (AB) =  $\angle N A S + \angle S A B$ . Hence, we can conclude that Forward Bearing =  $\angle N_1 B A + 180^\circ$ . As a general rule, if the Fore Bearing is less than 180°, add 180° to get the Back Bearing, and if the Fore Bearing is greater than 180°, then subtract 180° to get the Back Bearing.

## LECTURE 21

### Traversing and plotting with the compass survey:

Traversing with the compass involves taking the bearing along a series of connecting straight lines and in the same time measuring the distances with the tape. The compass is read at each point and a back bearing is equally taken to serve as a check. This continues until the traverse closes.

Choosing a suitable scale, the traverse is then plotted taking into consideration the general shape of the area.

### Observing Bearing of Line

- Consider a line AB of which the magnetic bearing is to be taken.
- By fixing the ranging rod at station B we get the magnetic bearing of needle wrt north pole.
- The enlarged portion gives actual pattern of graduations marked on ring. Designation of bearing

• The bearing are designated in the following two system:-

- 1) Whole Circle Bearing System.(W.C.B)
- 2) Quadrantal Bearing System.(Q.B)

### Whole circle bearing system (W.C.B.)

- The bearing of a line measured with respect to magnetic meridian in clockwise direction is called magnetic bearing and its value varies between  $0^{\circ}$  to  $360^{\circ}$ .
- The quadrant start from north and progress in a clockwise direction as the first quadrant is  $0^{\circ}$  to  $90^{\circ}$  in clockwise direction , 2nd  $90^{\circ}$  to  $180^{\circ}$  , 3rd  $180^{\circ}$  to  $270^{\circ}$ , and up to  $360^{\circ}$  is 4th one.

### Quadrantal bearing system(Q.B.)

- In this system, the bearing of survey lines are measured wrt to north line or south line whichever is the nearest to the given survey line and either in clockwise direction or in anti clockwise direction.

### Reduced bearing (R.B)

- When the whole circle bearing is converted into Quadrantal bearing , it is termed as REDUCED BEARING .
- Thus , the reduced bearing is similar to the Quadrantal bearing.

- Its values lies between  $0^{\circ}$  to  $90^{\circ}$ , but the quadrant should be mentioned for proper designation.

The following table should be remembered for conversion of WCB to RB.

W.C.B OF ANY LINE	QUADRANT IN WHICH IT LIES	RULES FOR CONVERSION	QUADRANT
0 TO 90	I	$RB = WCB$	N-E
90 TO 180	II	$RB = 180 - WCB$	S-E
180 TO 270	III	$RB = WCB - 180^{\circ}$	S-W
270 TO 360	IV	$RB = 360^{\circ} - WCB$	N-W

## LECTURE 22

### Error in compass survey (Local attraction & observational error):

- ▣ Local attraction is the influence that prevents magnetic needle pointing to magnetic north pole
- ▣ Unavoidable substance that affect are
  - Magnetic ore
  - Underground iron pipes
  - High voltage transmission line
  - Electric pole etc.
- ▣ Influence caused by avoidable magnetic substance doesn't come under local attraction such as instrument, watch wrist, key etc
- ▣ Detection of Local attraction
  - By observing the both bearings of line (F.B. & B.B.) and noting the difference (180° in case of W.C.B. & equal magnitude in case of R.B.)
  - We confirm the local attraction only if the difference is not due to observational errors.
- ▣ If detected, that has to be eliminated
- ▣ Two methods of elimination
  - First method
  - Second
- ▣ method First method
  - Difference of B.B. & F.B. of each line of traverse is checked to note if they differ by correctly or not.
  - The one having correct difference means that bearing measured in those stations are free from local attraction
  - Correction is accordingly applied to rest of station.
  - If none of the lines have correct difference between F.B. & B.B., the one with minimum error is balanced and repeat the similar procedure.
  - Diagram is good friend again to solve the numerical problem.

## LECTURE 23

### ▣ Second method

- Based on the fact that the interior angle measured on the affected station is right.
- All the interior angles are measured
- Check of interior angle – sum of interior angles =  $(2n-4)$  x right angle, where n is number of traverse side
- Errors are distributed and bearing of lines are calculated with the corrected angles from the lines with unaffected station.

### ▣ Checks in closed Traverse

- Errors in traverse is contributed by both angle and distance measurement
- Checks are available for angle measurement but
- There is no check for distance measurement
- For precise survey, distance is measured twice, reverse direction second time

### ▣ Checks for angular error are available

- Interior angle, sum of interior angles =  $(2n-4)$  x right angle, where n is number of traverse side
- Exterior angle, sum of exterior angles =  $(2n+4)$  x right angle, where n is number of traverse side

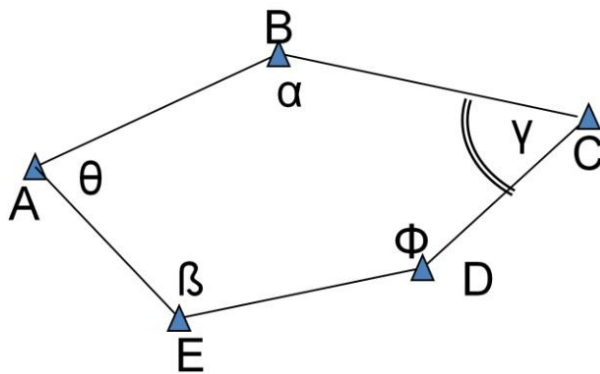

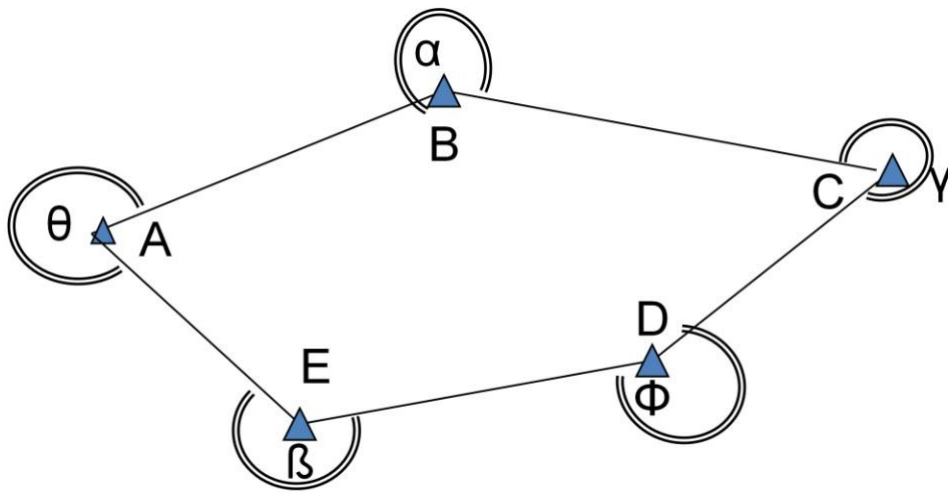

- Deflection angle – algebraic sum of the deflection angle should be 00 or 3600.
- Bearing – The fore bearing of the last line should be equal to its back bearing  $\pm 1800$  measured at the initial station.

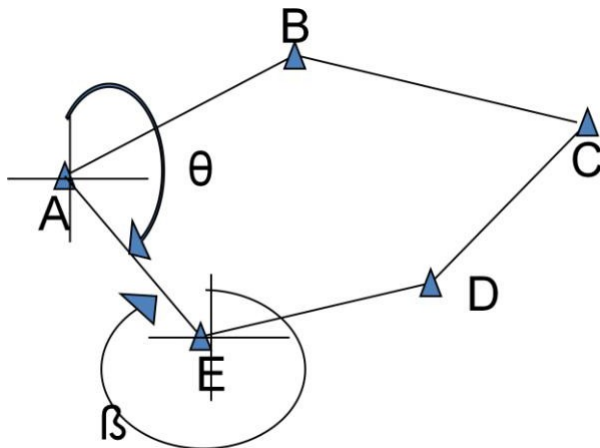

$\beta$  should be  $= \theta + 1800$

## LECTURE 24

### ▣ Checks in open traverse

- No direct check of angular measurement is available
- Indirect checks



Measure the bearing of line AD from A and bearing of DA from D

- ❖ Take the bearing to prominent points P & Q from consecutive station and check in plotting.

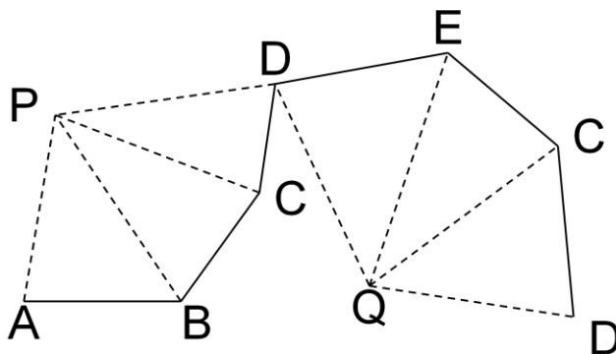
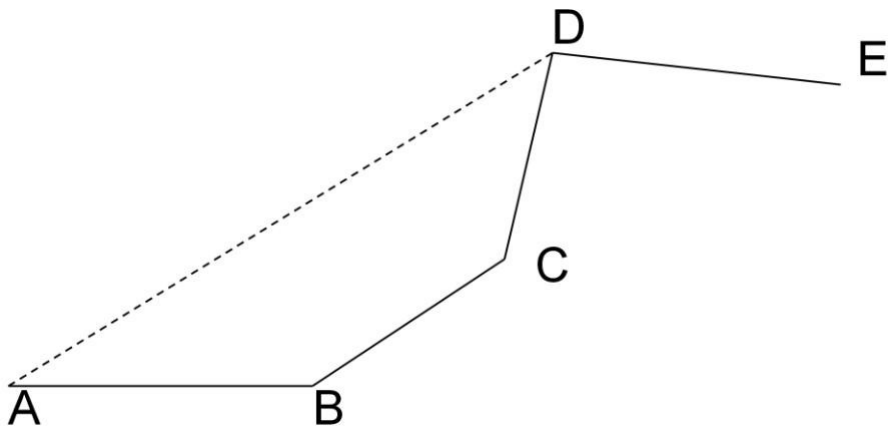

## Methods

### ➤ Compass rule (Bowditch)

- ❖ When both angle and distance are measured with same precision
- Transit rule
  - ❖ When angle are measured precisely than the length
- Graphical method

## Graphical rule

- Used for rough survey
- Graphical version of bowditch rule without numerical computation
- Geometric closure should be satisfied before this.

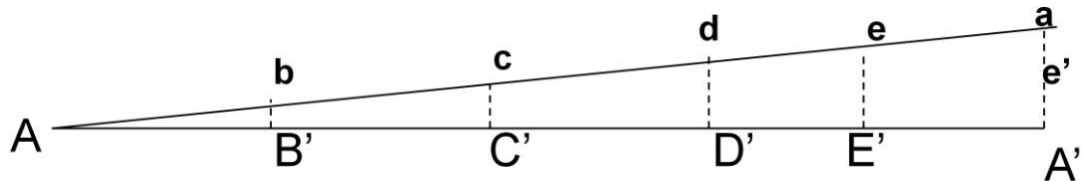
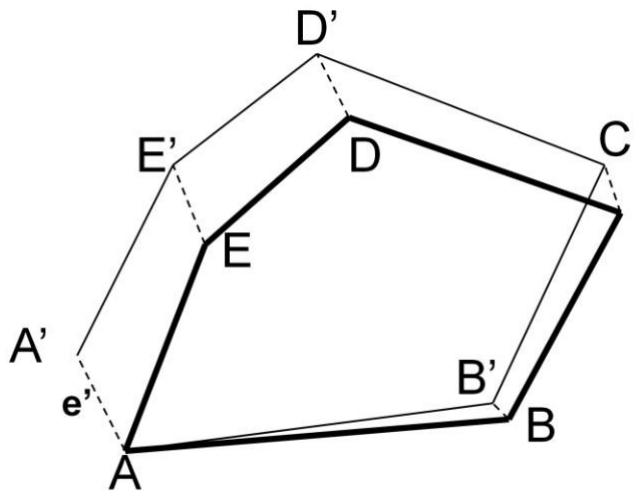





---

# LECTURE NOTE ON SURVEYING AND LEVELLING

---

4TH SEMESTER CIVIL ENGINEERING



**PREPARED BY SASWAT SUMAN SHARMA**

**DEPARTMENT OF CIVIL ENGINEERING**

## **Disclaimer**

This document does not claim any originality and cannot be used as a substitute for prescribed textbooks. The information presented here is merely a collection by the author for their respective teaching assignments. We would like to acknowledge various sources like freely available materials from internet from which the lecture note was prepared. The ownership of the information lies with the respective authors or institutions. Further, this document is not intended to be used for commercial purpose and the author is not accountable for any issues, legal or otherwise, arising out of use of this document. The author makes no representations or warranties with respect to the accuracy or completeness of the contents of this document and specifically disclaim any implied warranties of merchantability or fitness for a particular purpose.

## LECTURE 25

### LEVELLING

Levelling is the art of determining the elevation of given points above or below a datum line or establishing in given points of required height above or below the datum line. It evolves measurement in vertical plane.

Definition of basic terms used in levelling:

**Level surface:** Any surface parallel to the mean spheroid of the earth is called level surface and the line drawn on level surface is known as level line.

**Horizontal surface:** Any surface tangential to level surface at a given point is called - Horizontal surface at point. Hence horizontal line is at right angles to plumb line.

**Vertical surface:** It is the line connecting the point & centre of earth. Vertical & horizontal line is normal to each other.

**Datum:** The point or the surface with respect to which levels of other points or planes are calculated is called Datum or surface.

**Mean sea level (MSL):** Mean sea level is the average height of sea of all stages of tides. Any particular place is derived by averaging over a long period of 19 years. In India the mean sea level used is that at Karachi (Pakistan). In all important survey this is taken as datum.

**Reduced level:** Levels of various points are taken as heights above the datum surface are known as Reduced level.

**Bench mark:** Bench mark is a relatively permanent point of reference whose Elevation w.r.t some assumed datum is known. There are four types of bench mark

- G.T.S (Great trigonometry survey)
- Permanent bench mark
- Arbitrary bench mark.
- Temporary bench mark.

## **LEVELLING INSTRUMENTS:**

A level is an instrument giving horizontal line of sight & magnifying the reading far away from it. It consists of following 4 parts.

- v. Telescope to provide line of sight.
  
- vi. Level tube to make the line of sight horizontal.
  
- vii. The levelling head to bring the bubble in its centre of run.
  
- viii. A tripod to support instrument

## **TYPES OF LEVELS:**

- Dumpy level
- wye level
- Cooke's Reversible level
- Tilting level
- Auto level
- Cushing's level

## WORKING PRINCIPLE OF AUTO & DUMPY LEVEL:

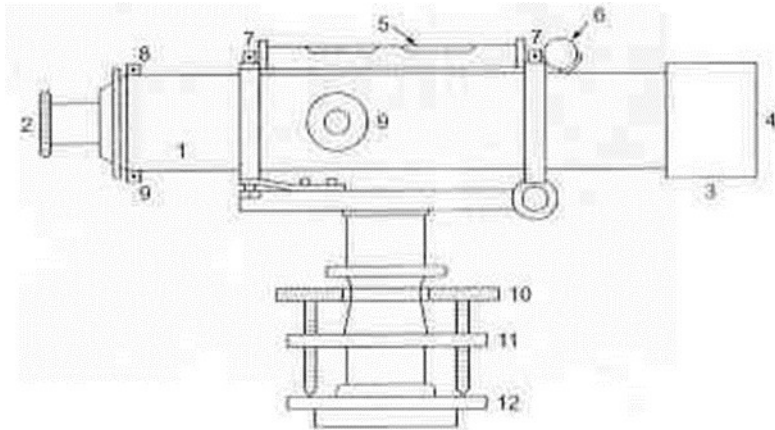

### PARTS OF FIGURE

- Telescope
- Eye piece
- Shade
- Objective end
- Longitudinal bubble
- Focusing screw
- Foot screws
- Upper parallel plate
- Diaphragm adjusting screws
- Bubble tube adjusting screw
- Transverse bubble tube
- Foot plate.

The dumpy level originally designed by Gravatt consists of a telescope tube firmly secured in two collars fixed by adjusting screws to the stage carried by the vertical spindle.

The modern form of dumpy level has the telescope tube & the vertical spindle cast as one piece & a long bubble tube is attached to the top of the telescope. This form is known as solid dumpy.

Levelling head generally consists of two parallel plates with either three- foot screws or four foot screws. The upper plate is known as tribrach. Lower part is known as trivet which can be screwed on to a tripod.

#### **The advantages of the dumpy level over the wye level:**

1. Simple construction with fewer movable parts
2. Fewer adjustments to be made
3. Longer life.

**Levelling staff:** A levelling staff is a straight rectangular rod having graduations. The foot of the staff representing 0 reading. During levelling staff is held vertical at the point and from level horizontal sight is taken.

Levelling staff may be divided into 2 groups

8. Self reading
9. Target staff.

#### **Parts of telescope:**

- iii) Objectives
- iv) Eye piece
- v) Diaphragm
- vi) Focusing device

### **Fundamental axis of a level:**

- (e) **Vertical axis:** It is the centre line of axis of notation of the level.
- (f) **Axis of level tube:** It is an imaginary line tangential to the longitudinal curve of the tube at its middle point. It is horizontal when the bubble is central.
- (g) **Axis of telescope:** It is the line joining the optical centre of the object glass & the centre of eye piece.
- (h) **Line of collimation or line of sight:** It is the line joining the intersection of cross hairs & optical centre of the object glass.

### **Temporary staff adjustment of a level:**

- v) Setting up
- vi) Levelling up
- vii) Focusing

**Setting up:** It is to set the tripod stand to a convenient height by bringing bubble to the centre of run through the movement of tripod legs radially.

**Levelling up:** To make the vertical axis truly vertical the levelling is made with the help of foot screws.

- (4) Loosen the clamp and turn the instrument until bubble axis is parallel to line joining any two screws.
- (5) Turn the two screws inward or outward equally till bubble is centered.
- (6) Turn the telescope through 90 degrees so that it lies over the third screw.

**Focusing:** For quantitative measurements it is essential that the image should always be formed in the fixed plane in the telescope where the cross hairs are situated

The operation of forming or bringing the clear image of the object in the pane of cross hairs is known as focusing

Complete focusing involves two steps

(iv) Focusing the eye piece

(v) Focusing the objective

Telescope in which the focusing is done by the external movement of either objective or eye piece is known as External focusing telescope.

Telescope in which the focusing is done by the internally with a negative lens is known as internal focusing telescope

Sensitiveness of a bubble tube: When the difference in elevation between any two points is determined from a single set up by back sighting on one point and fore sighting on the other. The error is due to non-parallelism. When the bubble is not in the centre of run and sensitivity is lost, due to the error of curvature and refraction which is eliminated if lengths of 2 sides are made equal.

Error due to Curvature: The horizontal line of sight does not remain straight but it slightly bends towards having concavity towards earth surface due to refraction.

$$C_c = d^2/2R$$

Error due to Refraction: As the line of sight is curved downwards towards the earth surface reading gets decreased. To make the objects appear higher than they really are, this correction is applied to staff readings,

$$C_R = 0.01121d^2$$

where d is in km.



## **TERMS USED IN LEVELLING:**

- (d) Station: Station is the point where levelling staff is held & not the point where level is kept.
- (e) Height of instrument: For any set up of the level the height of instrument is the elevation of the plane of sight respect to assumed datum. This also known as plane of collimation.
- (f) Back sight: It is sight taken on a level staff held at a point of known elevation with an intension of determining plane of collimation or sight.
- (g) Intermediate sight (I.S): Sight taken on after taking back sights before taking last sight from an instrument station is known as intermediate sight. The sight is also known as +ve sight (add)
- (h) Fore sight (F.S): This is the last reading taken from instrument just before shifting the instrument. This is also ve sight.
- (i) Change point (C.P): This is a point on which both fore sight & back sight are taken.
- (j) Reduced level: Reduced level of a point is the level of the point with respect to assumed datum.

## **TYPES OF LEVELLING**

- v) Simple levelling
- vi) Differential levelling
- vii) Fly levelling
- viii) Profile levelling
- ix) Cross-sectioning
- x) Reciprocal levelling

**Simple levelling:** It is the difference in levels of two near by points. It is obtained by simple levelling

**Differential levelling:** When the distance between two points is very large it may not be possible to take the readings from single setting of instruments. Each shifting facilitated by taking CP.

**Fly levelling:** It is to carry out levelling with respect to temporary bench mark in convenient direction taking number of CP

**Crosssectioning:** In many engineering projects to calculate earth work involved not only LS is involved but CS of ground is taken in regular intervals.

**Reciprocal levelling:** When it is not possible to balance FS and BS due to non-parallelism of line of collimation and axis of bubble tube and also due curvature and refraction this is used.

$$H = [(h_a - h_b) + (h'_a - h'_b)]/2$$

#### **PROFILE LEVELLING:**

This type of levelling is known as longitudinal section.

The reduced levels of various points at regular intervals are found along a line or a set of lines. Then the engineers draw the sectional view of the ground to get the profile. This type of levelling is commonly employed in deciding railways, highways, canal, sewage line routes.

After getting reduced level of various points along the line, profile of the ground is plotted on a drawing sheet. Normally vertical scale is much larger than the horizontal scale to clearly view the profile. Then when the engineers decide the formation level of the proposed project The decision is mainly based on balancing, cutting & filling so that the transport of earth is minimum. However, the proposed gradient of formation level should not be more than as permitted. After deciding the formation level & the gradient the difference between two consecutive points is known. If RL of first point is known RL of other points are calculated.

**STEPS TO TAKE OBSERVATION:**

5. Differential levelling is the method of direct levelling the object of which is. To determine Difference in elevations of two points regardless of horizontal position of point with respect to each Other, when points are apart it may be necessary to setup the instrument several times. This type of Levelling is also known as FLY LEVELLING .
6. Instrument level is setup at convenient positions near first point (say A).
7. Temporary adjustments should be done, (setting up, levelling up, elimination of a par- allot) are Performed.
8. First sight of B.M (point of known elevation) is taken and reading is entered in back Sight column.
9. If distance is large instrument is shifted, the instrument becomes turning point (or) changing point.
10. After setting up instrument at new position, performing temporary adjustment and Take back sight as turning point.
11. Thus, turning point will have both back sight and fore sight readings.
12. Link wise the process is repeated till last point (say B) is reached.
13. Readings are entered in a tabular form is given Below and Reduced levels are calculated either by height of instrument method (or) rise and fall method.

STATION POINT	BACK SIGHT	INTERMIDEATE SIGHT	FORESIGHT	HEIGHT OF INSTRUMENT	REDUCED LEVEL	REMARKS

ARITHMETIC CHECK:  $-\Sigma B.S - \Sigma F. S = \Sigma RISE - \Sigma FALL = LAST RL - FIRST R.L$



---

# LECTURE NOTE ON SURVEYING AND LEVELLING

---

4TH SEMESTER CIVIL ENGINEERING



**PREPARED BY SASWAT SUMAN SHARMA**

**DEPARTMENT OF CIVIL ENGINEERING**

## **Disclaimer**

This document does not claim any originality and cannot be used as a substitute for prescribed textbooks. The information presented here is merely a collection by the author for their respective teaching assignments. We would like to acknowledge various sources like freely available materials from internet from which the lecture note was prepared. The ownership of the information lies with the respective authors or institutions. Further, this document is not intended to be used for commercial purpose and the author is not accountable for any issues, legal or otherwise, arising out of use of this document. The author makes no representations or warranties with respect to the accuracy or completeness of the contents of this document and specifically disclaim any implied warranties of merchantability or fitness for a particular purpose.

## LECTURE 26

### THEODOLITE TRAVERSING

A theodolite is a precision instrument for measuring angles in the horizontal and vertical planes. Theodolites are used mainly for surveying applications, and have been adapted for specialized purposes.

The theodolite is a complex instrument used mainly for accurate measurement of horizontal and vertical angle up to 10" or 20" depending upon the least count of the instrument.

### USES OF THEODOLITE:

Following are the different purpose for which theodolite can be used-

- Measuring horizontal angle
- Measuring vertical angle
- Measuring deflection angle
- Measuring magnetic bearing
- Measuring the horizontal distance between two points
- Finding vertical height of an object
- Finding difference of elevation between various points
- Ranging of a line

### Types of Theodolite:

Theodolites may be broadly classified into two types-

vii) Transit theodolite

viii) Non- transit theodolite

ix) Vernier Theodolite

## DIFFERENT PARTS OF THEODOLITE:

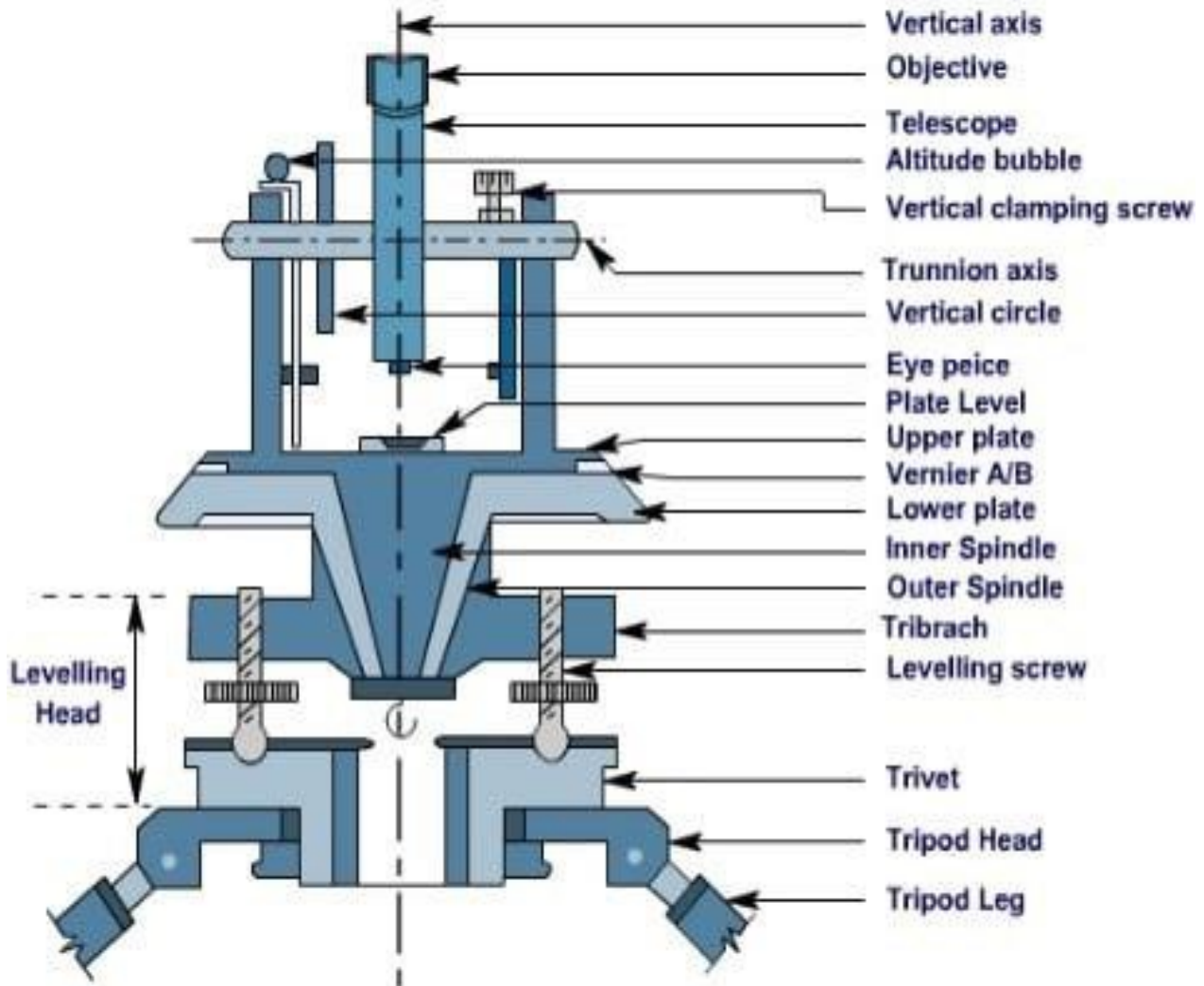

10. **Vertical Scale (or Vertical Circle):** The vertical circle is a full 360° scale. It is mounted within one of the standards with its centre co-linear with the trunnion axis. It is used to measure the angle between the line of sight (collimation axis) of the telescope and the horizontal. This is known as the vertical angle.

11. **Telescope:** It has the same features as in a level graticule with eyepiece and internal focussing for the telescope itself. The same precautions for focussing the eyepiece and eliminating parallax should be applied.

12. **Vertical Clamp and Tangent Screw:** In order to hold the telescope at a particular vertical angle a vertical clamp is provided. This is located on one of the standards and its release will allow free transiting of the telescope. When clamped, the telescope can be slowly transited using another fine adjustment screw known as the vertical tangent screw.

13. **Upper Plate:** The upper plate is the base on which the standards and vertical circle are placed. Rotation or transiting of the upper plate about a vertical (alidade) axis will also cause the entire standards/telescope assembly to rotate in an identical manner. For the instrument to be in correct adjustment it is therefore necessary that the upper plate must be perpendicular to the alidade axis and parallel to the trunnion axis. Also, before the instrument is used, the upper plate must be "levelled". This is achieved by adjustment of three-foot screws and observing a precise tube bubble. This bubble is known as the plate bubble and is placed on the upper plate.
14. **The Lower Plate:** The lower plate is the base of the whole instrument. It houses the foot screws and the bearing for the vertical axis. It is rigidly attached to the tripod mounting assembly and does not move.
15. **Horizontal Scale:** The horizontal circle is a full  $360^\circ$  scale. It is often placed between the upper and lower plates with its centre co-linear with the vertical axis. It is capable of full independent rotation about the trunnion axis so that any particular direction may be arbitrarily set to read zero. It is used to define the horizontal direction in which the telescope is sighted. Therefore, a horizontal angle measurement requires two horizontal scale readings taken by observing two different targets.
16. **The Upper Horizontal Clamp and Tangent Screw:** The upper horizontal clamp is provided to clamp the upper plate to the horizontal circle. Once the clamp is released the instrument is free to traverse through  $360^\circ$  around the horizontal circle. When clamped, the instrument can be gradually transited around the circle by use of the upper horizontal tangent screw. It is the upper clamp and tangent screw which are used during a sequence or "round" of horizontal angle measurements.
17. **The Lower Horizontal Clamp and Tangent Screw:** The lower horizontal clamp is provided to clamp the horizontal circle to the lower plate. Once the clamp is released the circle is free to rotate about the vertical axis. When clamped, the horizontal circle can be gradually rotated using the lower-horizontal tangent screw. The lower clamp and tangent screw must only be used at the start of a sequence or "round" of horizontal angle measurements to set the first reading to zero (if so desired).
18. **Optical Micrometre:** Modern instruments usually have one eyepiece for reading both circles. It is usually located on one of the standards. The vertical and horizontal circles require illumination in order to read them. This is usually provided by small circular mirrors which can be angled and rotated to reflect maximum light onto the circles.
19. **Index bar or T-frame:** The index bar is T shaped and centered on horizontal axis of the telescope in front of the vertical axis. It carries two Vernier of the extremities of its horizontal arms or limbs called the index arm. The vertical leg called the clip or clipping screws at its lower extremity. The index arm and the clipping arm are together known as T-frame.



20. **Altitude level:** A highly sensitive bubble is used for levelling particularly when taking the vertical angle observations.
21. **Plumb bob:** To centre the instrument exactly over a station mark, a plumb bob is suspended from the hook fitted to the bottom of the central vertical axis.
22. **The levelling head:** It may consist of circular plates called as upper and lower Parallel plates. The lower parallel plate has a central aperture through which a plumb bob may be suspended. The upper parallel plate or tribrach is supported by means of four or three levelling screws by which the instrument may be levelled.
23. **Standards or A-Frame:** The frames supporting telescope are in the form of English letter A . This frame allows telescope to rotate on its trunnion axis in vertical frame. The T-frame and the clamps are also fixed to this frame.

### IMPORTANT TERMS:

9. **Centering:** The setting of theodolite exactly over a station marked by means of plumb bob is known as centering.
10. **Transiting:** The method of turning the telescope about its horizontal axis in a vertical plane through 180° is termed as transiting. In other words, transiting results in a change of face.
11. **Face left:** It means that the vertical circle of theodolite is on the left of the observer at the time of taking reading.
12. **Face right:** This refers to the situation when the vertical circle of the instrument is on the right of the observer when the reading is taken.
13. **Changing face:** The operation of bringing the vertical circle from one side of the observer to the other is known as changing face.
14. **Swinging the telescope:** This indicates turning the telescope in a horizontal plane. It is called 'right swing' when the telescope is turned clockwise and 'left swing' when the telescope is turned anticlockwise.
15. **Line of collimation:** It is an imaginary line passing through the optical centre of the objective glass and its continuation.
16. **Axis of telescope:** The axis is an imaginary line passing through the optical centre of the object glass and optical centre of eyepiece.
17. **Axis of the bubble tube:** It is an imaginary line tangential to longitudinal curve of bubble tube at its middle point.

18. **Vertical axis:** It is the axis of rotation of the telescope in the horizontal plane.
19. **Horizontal axis:** It is the axis of rotation of the telescope in the vertical plane.
20. **Temporary adjustment:** The setting of the theodolite over a station at the time of taking any observation is called temporary adjustment.
21. **Permanent adjustment:** When the desired relationship between fundamental lines is disturbed, then some procedures are adopted to establish this relationship. This adjustment is known as permanent adjustment.

### USE OF THEODOLITE:

Theodolite is used for measuring horizontal and vertical angles. For this the theodolite should be centered on the desired station point, levelled and telescope is focussed. This process of centering, levelling and focussing is called temporary adjustment of the instrument.

#### Measurement of Horizontal Angle

The procedure is explained for measuring horizontal angle  $\theta = \text{PQR}$  at station Q

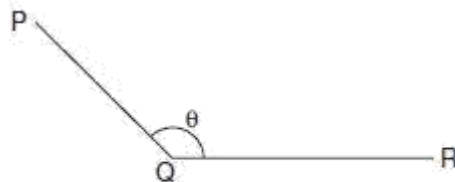

Fig. 16.5

1. Set the theodolite at Q with vertical circle to the left of the line of sight and complete all temporary adjustments.
2. Release both upper and lower clamps and turn upper plate to get  $0^\circ$  on the main scale. Then clamp main screw and using tangent screw get exactly zero reading. At this stage Vernier A reads  $0^\circ$  and Vernier B reads  $180^\circ$ .
3. Through telescope take line of sight to signal at P and lock the lower clamp. Use tangent Screw for exact bisection.
4. Release the upper clamp and swing telescope to bisect signal at R. Lock upper clamp and use tangent screen to get exact bisection of R.
5. Read Vernier s A and B. The reading of Vernier A gives desired angle PQR directly, while  $180^\circ$  is to be subtracted from the reading of Vernier B to get the angle PQR.

6. Transit (move by 180° in vertical plane) the telescope to make vertical circle to the right of telescope. Repeat steps 2 to 5 to get two more values for the angle.

7. The average of 4 values found for  $\theta$ , give the horizontal angle. Two values obtained with face left and two obtained with face right position of vertical circle are called one set of readings.

8. If more precision is required the angle may be measured repeatedly. i.e., after step 5, release lower clamp, sight signal at P, then lock lower clamp, release upper clamp and swing the telescope to signal at Q. The reading of Vernier A doubles. The angle measured by Vernier B is also doubled. Any number of repetitions may be made and average taken. Similar readings are then taken with face right also. Finally, average angle is found and is taken as desired angle Q. This is called method of repetition.

9. There is another method of getting precise horizontal angles. It is called method of reiteration. If a number of angles are to be measured from a station this technique is used.

With zero reading of Vernier A signal at P is sighted exactly and lower clamp and its tangent screw are locked. Then  $\theta_1$  is measured by sighting Q and noted. Then  $\theta_2$ ,  $\theta_3$  and  $\theta_4$  are measured by unlocking upper clamp and bisecting signals at R, S and P. The angles are calculated and checked to see that sum is 360°. In each case both veneers are read and similar process is carried out by changing the face (face left and face right).

Instrance at	Signal	Face left Swing right				Face right swing left				Average Horizontal Angle
		A	B	Mean	Horizontal Angle	A	B	Mean	Horizontal Angle	

**By Repetition Method:**

The method of repetition is used to measure a horizontal angle to a finer degree of accuracy. By this method, an angle is measured two or more times by allowing the Vernier to remain clamped each time at the end of each measurement instead of setting it back at zero when sighting at the previous station. Thus an angle reading is mechanically added several times depending upon the number of repetitions. The average horizontal angle is then obtained by dividing the final reading by the number of repetitions. For very accurate work the method of repetition is used.

### **Measurement of Vertical Angle**

Horizontal sight is taken as zero vertical angle. Angle of elevations are noted as +ve angles and angle of depression as -ve angles.

To measure vertical angle the following procedure may be followed:

1. Complete all temporary adjustment at the required station.
2. Take up levelling of the instrument with respect to altitude level provided on the A frame. This levelling process is similar to that used for levelling dumpy level i.e., first altitude level is kept parallel to any two levelling screws and operating those two screws bubble is brought to centre. Then by rotating telescope, level tube is brought at right angles to the original position and is levelled with the third screw. The procedure is repeated till bubble is centred in both positions.
3. Then loosen the vertical circle clamp, bisect P and lock the clamp. Read verniers C and D to get vertical angle.

The observation recorded by the above process is then entered to the table in a specific format given below.

Station	Object	Face	Reading		Reading		Mean Vernier A	Mean Vernier B	Mean Face angle
			Vernier A		Vernier B				
			Initial	Final	Initial	Final			

### THEODOLITE TRAVERSING:

**Introduction:** A traverse consists of a series of straight lines connecting successive points. The points defining the ends of the traverse lines are called traverse stations or traverse points. Distance along the line between successive traverse points is determined either by direct measurement using a tape or electronic distance measuring (EDM) equipment, or by indirect measurement using tachometric methods. At each point where the traverse changes direction, an angular measurement is taken using a theodolite.

**Purpose of traverse:** It is a convenient, rapid method for establishing horizontal control particularly when the lines of sights are short due to heavily built up areas where triangulation and trilateration are not applicable. The purpose includes:

6. Property surveys to locate or establish boundaries;
7. Supplementary horizontal control for topographic mapping surveys;
8. Location and construction layout surveys for high ways, railway, and other private and public works;
9. Ground control surveys for photogrammetric mapping.

## METHODS FOR CLOSED TRAVERSE:

- Included angle method  
Magnetic bearing method

### Included Angle method:

2. For running the traverse ABCDEFG Set up the theodolite at 1ST station A and observed the bearing of the line AB.
3. Then measure the angle GAB. Shift the instrument to each of the successive station B, C etc. and measure the angles ABC, BCD etc.
4. Measure the line AB, BC, CD etc. and take offset to locate the required detail after this check is applied for interiors angles it is  $(2n-4) \times 900$ ,
5. And for exterior angles it is  $(2n+4) \times 900$

$n$  = number of sides of the traverse

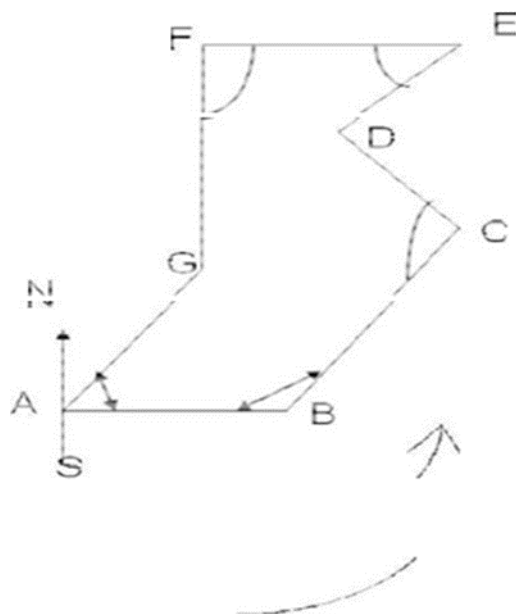

INSRT ST	O B J E C T	F A C E	A N G L E	READING ON VERNIER		ANGLE ON VERNIER		MEAN ANGLE OF VERNIER	MEAN ANGLE OF OBSERVATIONS	LENGTH	W C B
				A	B	A	B				
A	E	L	A								
	B	R									
A	E	L	A								
	B	R									
B	A	L	B								
	C	R									
B	A	L	B								
	C	R									
C	B	L	C								
	D	R									
C	B	L	C								
	D	R									
D	C	L	D								
	E	R									
D	C	L	D								
	E	R									
E	D	L	E								
	A	R									
E	D	L	E								
	A	R									

### **Magnetics Bearing Method:**

- (k) Set up and level the theodolite at station P of the traverse PQRSTP, a closed traverse.
- (l) Using the upper clamp and upper tangent screw, set Vernier A to read zero.
- (m) Loosen the magnetic needle. Release the lower clamp and point the telescope in the direction of the magnetic meridian till the magnetic needle comes to rest at the zero-position using the lower tangent screw the north end of the magnetic needle to read exactly zero.
- (n) Release the upper plate and swing the instrument to bisect the signal at Q. With the upper tangent screw, bisect the station mark exactly. Read Vernier A, this gives the bearing of the line PQ.
- (o) Keeping both the clamps tight, shift the instrument to Q. Set up and level the instrument.
- (p) Check the reading on Vernier A. It should be the same as the magnetic
- (q) bearing of the line PQ (if not, this can be corrected and the bearing value noted earlier be set on Vernier A).
- (r) Release the upper clamp. Swings the instrument clockwise to bisect the station mark at R. Using upper tangent screw bisect mark R exactly. Read the Vernier at A and note down the reading.
- (s) With both clamps tight, shift the instrument to R and repeat the procedure. The work is continued at all stations in a similar manner.



Inst Station	observation	Vernier		line	length	Bearing
		A	B			

**Latitudes and Departures:**

Latitude is the north-south component of a line; departure the east-west. North latitudes are positive, South are negative; similarly, East departures are positive, West are negative.

Latitude (Lat) and Departure (Dep) are computed from:

$$\text{Lat} = \text{Length} \times \cos(\text{Dir})$$

$$\text{Dep} = \text{Length} \times \sin(\text{Dir})$$

Because a bearing angle never exceeds 90°, the Lat and Dep equations will always return positive values.

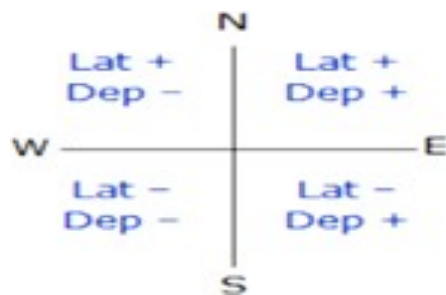

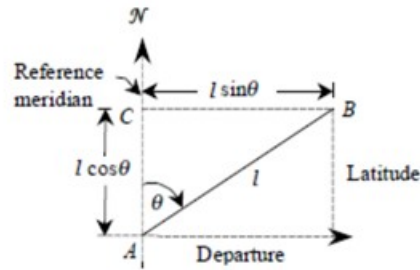
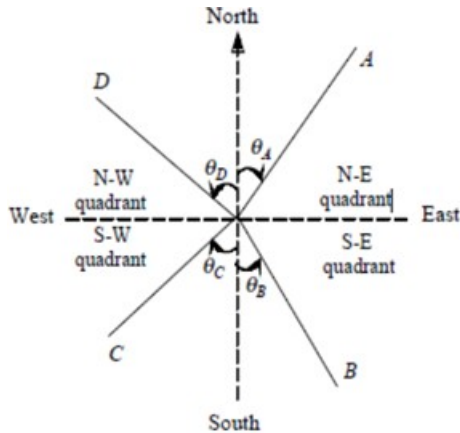

### BALANCING THE TRAVERSE

In a closed traverse the following conditions must be satisfied:

$$\Sigma \text{ Departure} = \Sigma D = 0$$

$$\Sigma \text{ Latitude} = \Sigma L = 0$$

If the above conditions are not satisfied, the position A of the originating stations and its computed position A' will not be the same as due to the observational errors.

The distance AA' between them is known as the closing error. The closing error is given by

$$e = \sqrt{(\Sigma D)^2 + (\Sigma L)^2}$$

and its direction or reduced bearing is given by

$$\tan \theta = \frac{(\Sigma D)}{(\Sigma L)}$$

The term balancing is generally applied to the operation of adjusting the closing error in a closed traverse by applying corrections to departures and latitudes to satisfy the conditions given by the equations.

The following methods are generally used for balancing a traverse:

**Bowditch's method:** when the linear errors are proportional to  $\sqrt{l}$  and angular errors are proportional to  $1/\sqrt{l}$ , where  $l$  is the length of the line. This rule can also be applied graphically when the angular measurements are of inferior accuracy such as in compass surveying. In this method the total error in departure and latitude is distributed in proportion to the length of the traverse line. Therefore,

$$c_D = \Sigma D \frac{l}{\Sigma l}$$

$$c_L = \Sigma L \frac{l}{\Sigma l}$$

where

$C_D$  and  $C_L$  = the corrections to the departure and latitude of the line to which the correction is applied,

$l$  = the length of the line, and

$\Sigma l$  = the sum of the lengths of all the lines of the traverse, i.e., perimeter  $p$ .

**Transit rule:** when the angular measurements are more precise than the linear measurements.

By transit rule, we have

$$C_D = \Sigma D \frac{D}{D_T}$$

$$C_L = \Sigma L \frac{L}{L_T}$$

where  $C_D$  and  $C_L$  = the departure and latitude of the line to which the correction is applied, and

$D_T$  and  $L_T$  = the arithmetic sum of departures and latitudes all the lines of the traverse, (i.e., ignoring the algebraic signs)

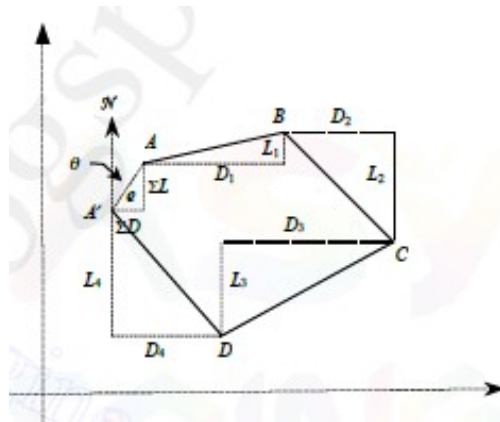

### GALE'S TRAVERSE TABLE

In the field usually lengths and inward angles of a closed traverse are measured.

In addition, bearing of a line is taken. For adjustment of the traverse, the field data and computations are systematically recorded in a table known as Gale's Traverse Table. The steps involved are:

- Write the names of the traverse stations in column 1 of the table. "
- Write the names of the traverse lines in column 2.
- Write the lengths of the various lines in column 3.

- Write the angles in column 4.
- Sum up all the angles and see whether they satisfy the geometric conditions as applicable, i.e.  
 sum of interior angles =  $(2n - 4)$  right angles, (ii) sum of all exterior angles =  $(2n + 4)$  right angles.
- if not, adjust the discrepancy.
- Enter corrections in column 5.
- Write the corrected angles in column 6.
- Starting from the actual or assumed bearing of the initial line, calculate the whole circle bearings of all other lines from the corrected angles and enter in column 7.
- Convert the whole circle bearings to reduced bearings and enter in column 8.
- Enter the quadrants of the reduced bearings in column 9.
- Compute the latitudes and departures of the measured lines from lengths and bearings and put in proper columns 10, 11, 12 and 13 as applicable. Sum up the latitudes and departures to find the closing error.
- Calculate corrections by applying Transit rule or Bowditch's rule as desired.
- Enter the corrections in appropriate columns 14 to 17.
- Determine the corrected latitudes and departures and enter in appropriate columns 18 to 21. They will be corrected consecutive coordinates.
- Calculate the independent coordinates of all other points from the known or assumed independent coordinates of the first station. As a check the independent coordinates of the first point should be computed. It should tally with the known or assumed value.

### **BALANCING THE CLOSING ERROR GRAPHICALLY:**

For rough surveys or traverse of small area, adjustment can also be carried out graphically. In this method of balancing, the locations and thus the coordinates of the stations are adjusted directly. Thus, the amount of correction at any station is proportional to its distance from the initial station.

Let  $P_0, Q, R, S, T, P'$  is the graphical plot of a closed-loop traverse PQRSTP. The observed length and direction of traverse sides are such that it fails to get balanced and is depicted in its graphical presentation by an amount  $P_0 P'$ .

Thus, the closing error of the traverse is  $P_0 P'$  (Given in Figure below). The error  $P_0 P'$  is to be distributed to all the sides of the traverse in such a way that the traverse gets closed i.e.,  $P'$  gets coincides with  $P_0$  in its plot.

This is carried out by shifting the positions of the station graphically. In order to obtain the length and direction of shifting of the plotted position of stations, first a straight line is required to be drawn, at some scale, representing the perimeter of the plotted traverse.

In this case, a horizontal line  $P_0 P'$  is drawn (Given in Figure below). Mark the traverse stations on this line such as  $Q_0, R_0, S_0$  and  $T_0$  in such a way that distance between them represent the length of the traverse sides at the chosen scale.

At the terminating end of the line i.e., at  $P'$ , a line  $P' P_a$  is drawn parallel to the correction for closure and length equal to the amount of error as depicted in the plot of traverse. Now, join  $P_0$  to  $P_a$  and draw lines parallel to  $P' P_a$  at points  $Q_0, R_0, S_0$  and  $T_0$ .

The length and direction of  $Q_0 Q_a, R_0 R_a, S_0 S_a$  and  $T_0 T_a$  represent the length and direction of errors at  $Q_0, R_0, S_0$  and  $T_0$  respectively. So, shifting equal to  $Q_0 Q_a, R_0 R_a, S_0 S_a$  and  $T_0 T_a$  and in the same direction are applied as correction to the positions of stations  $Q_0, R_0, S_0$  and  $T_0$  respectively. These shifting provide the corrected positions of the stations as  $Q_a, R_a, S_a, T_a$  and  $P_a$ . Joining these corrected positions of the stations provide the adjusted traverse  $P_a Q_a R_a S_a T_a$  (Given in Figure below).

