

**LECTURE NOTES**

**Structural Design -II**

**PREPARED BY: SUSHREE SOURAVI ROUT**

**DEPARTMENT OF CIVIL ENGINEERING**

## UNIT – I

### SIMPLE CONNECTIONS, RIVETED, BOLTED AND WELDED CONNECTIONS

In engineering practice it is often required that two sheets or plates are joined together and carry the load in such ways that the joint is loaded. Many times such joints are required to be leak proof so that gas contained inside is not allowed to escape. A riveted joint is easily conceived between two plates overlapping at edges, making holes through thickness of both, passing the stem of rivet through holes and creating the head at the end of the stem on the other side. A number of rivets may pass through the row of holes, which are uniformly distributed along the edges of the plate. With such a joint having been created between two plates, they cannot be pulled apart. If force at each of the free edges is applied for pulling the plate apart the tensile stress in the plate along the row of rivet hole and shearing stress in rivets will create resisting force. Such joints have been used in structures, boilers and ships. The following are the usual applications for connection.

1. Screws ,
2. Pins and bolts,
3. Cotters and Gibs,
4. Rivets,
5. Welds.

Of these screws, pins, bolts, cotters and gibs are used as temporary fastening i.e., the components connected can be separated easily. Rivets and welds are used as permanent fastenings i.e., the components connected are not likely to require separation.

#### RIVETS

Rivet is a round rod which holds two metal pieces together permanently. Rivets are made from mild steel bars with yield strength ranges from  $220 \text{ N/mm}^2$  to  $250 \text{ N/mm}^2$ . A rivet consists of a head and a body as shown in Fig.1. The body of rivet is termed as shank. The head of rivet is formed by heating the rivet rod and upsetting one end of the rod by running it into the rivet machine. The rivets are manufactured in different lengths to suit different purposes. The size of rivet is expressed by the diameter of the shank.

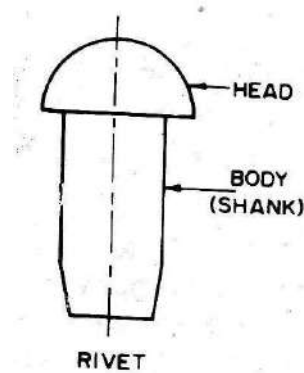

Fig. 1 Parts of Rivet

Holes are drilled in the plates to be connected at the appropriate places. For driving the rivets, they are heated till they become red hot and are then placed in the hole. Keeping the rivets pressed from one side, a number of blows are applied and a head at the other end is formed. When the hot rivet so fitted cools it shrinks and presses the plates together. These rivets are known as hot driven rivets. The hot driven rivets of 16 mm, 18 mm, 20 mm and 22 mm diameter are used for the structural steel works.

Some rivets are driven at atmospheric temperature. These rivets are known as cold driven rivets. The cold driven rivets need larger pressure to form the head and complete the driving. The small size rivets ranging from 12 mm to 22 mm in diameter may be cold driven rivets. The strength of rivet increases in the cold driving. The use of cold driven rivets is limited because of equipment necessary and inconvenience caused in the field.

The diameter of rivet to suit the thickness of plate may be determined from the following formulae:

1. Unwins's formula  $d=6.05 t^{0.5}$
2. The French formula  $d=1.5 t + 4$
3. The German formula  $d=(50 t - 2)^{0.5}$

Where  $d$ = nominal diameter of rivet in mm and  $t$ = thickness of plate in mm.

#### RIVET HEADS

The various types of rivet heads employed for different works are shown in Fig. 5.2. The proportions of various shapes of rivet heads have been expressed in terms of diameter 'D' of the shank of rivet. The snap head is also termed as round head and button head. The snap heads are used for rivets connecting structural members. Sometimes it becomes necessary to flatten the rivet heads so as to provide sufficient clearance. A rivet head which has the form of a truncated cone is called a countersunk head. When a smooth flat surface is required, it is necessary to have rivets countersunk and chipped.

#### RIVET HOLES

The rivet holes are made in the plates or structural members by punching or drilling. When the holes are made by punching, the holes are not perfect, but taper. A punch damages the material around the hole. The operation known as reaming is done in the hole made by punching. When the holes are made by drilling, the holes are perfect and provide good alignment for driving the rivets. The diameter of a rivet hole is made larger than the nominal diameter of the rivet by 1.5 mm of rivets less than or equal to 25 mm diameter and by 2 mm for diameter exceeding 25 mm.

#### DEFINITIONS OF TERMS USED IN RIVETING

##### **Nominal diameter of rivet (d):**

The nominal diameter of a rivet means the diameter of the cold shank before driving.

##### **Gross diameter of rivet (D):**

The diameter of the hole is slightly greater than the diameter of the rivet shank. As the rivet is heated and driven, the rivet fills the hole fully. The gross or effective diameter of a rivet means the diameter of the hole or closed rivet. Strengths of rivet are based on gross diameter.

##### **Pitch of rivet (p):**

The pitch of rivet is the distance between two consecutive rivets measured parallel to the direction of the force in the structural member, lying on the same rivet line. Minimum pitch should not be less than 2.5 times the nominal diameter of the rivet. As a thumb rule pitch equal to 3 times the nominal diameter of the rivet is adopted. Maximum pitch shall not exceed 32 times the thickness of the thinner outside plate or 300 mm whichever is less.

##### **Gauge distance of rivets (g):**

The gauge distance is the transverse distance between two consecutive rivets of adjacent chains (parallel adjacent lines of fasteners) and is measured at right angles to the direction of the force in the structural member.

##### **Gross area of rivet:**

The gross area of rivet is the cross sectional area of a rivet calculated from the gross diameter of the rivet.

##### **Rivet line:**

The rivet line is also known as scribe line or back line or gauge line. The rivet line is the imaginary line along which rivets are placed. The rolled steel sections have been assigned standard positions of the rivet lines. The standard position of rivet lines for the various sections may be noted from ISI Handbook No.1 for the respective sections. These standard positions of rivet lines are conformed to whenever possible. The departure from standard position of the rivet lines may be done if necessary. The dimensions of rivet lines should be shown irrespective of whether the standard positions have been followed or not.

##### **Staggered pitch:**

The staggered pitch is also known as alternate pitch or reeled pitch. The staggered pitch is defined as the distance measured along one rivet line from the centre of a rivet on it to the centre of the adjoining rivet on the adjacent parallel rivet line. One or both the legs of an angle section may have double rivet lines. The staggered pitch occurs between the double rivet lines.

## TYPES OF JOINTS

Riveted joints are mainly of two types, namely, Lap joints and Butt joints.

**Lap Joint:** Two plates are said to be connected by a lap joint when the connected ends of the plates lie in parallel planes. Lap joints may be further classified according to number of rivets used and the arrangement of rivets adopted. Following are the different types of lap joints.

1. Single riveted lap joint (Fig.),
2. Double riveted lap joint:

- a. Chain riveted lap joint (Fig.)
- b. Zig-zag riveted lap joint (Fig.)

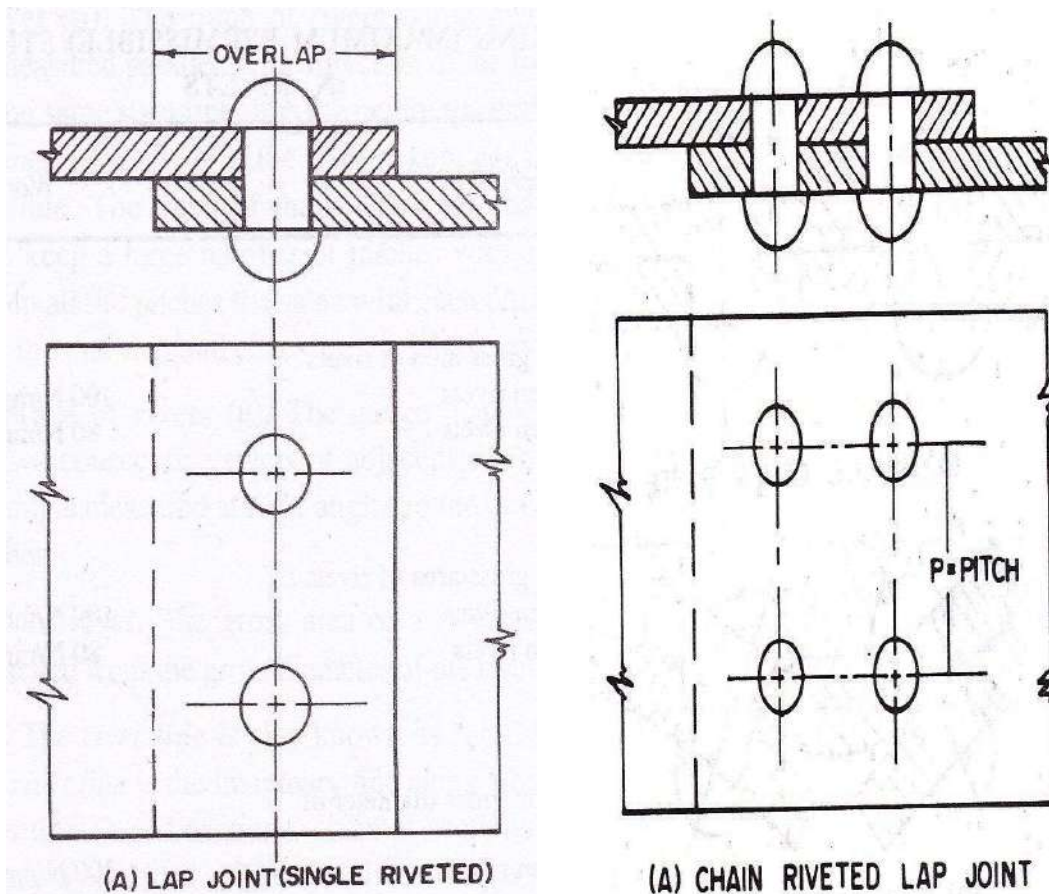
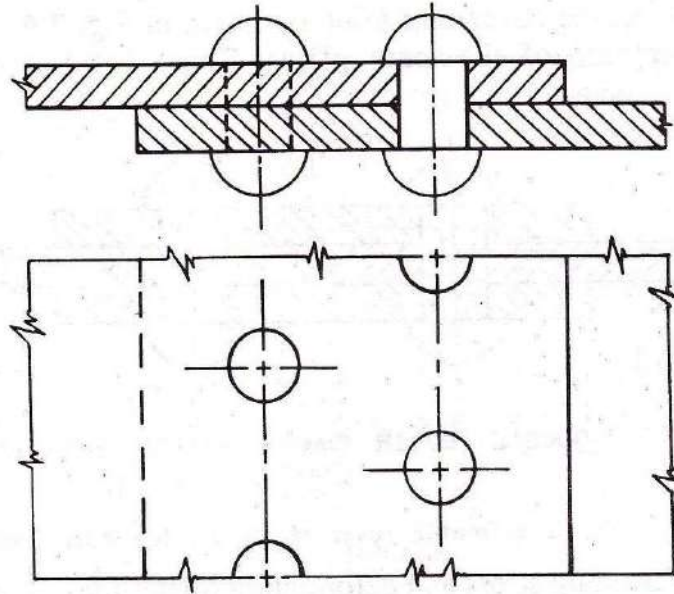

Fig. 2 lap joint



(B) ZIG-ZAG RIVETED LAP JOINT

Fig. 3 Zig-Zag Lap Joint

### Butt Joint:

In a butt joint the connected ends of the plates lie in the same plane. The abutting ends of the plates are covered by one or two cover plates or strap plates. Butt joints may also be classified into single cover butt joint, double cover butt joints. In single cover butt joint, cover plate is provided on one side of main plate. In case of double cover butt joint, cover plates are provided on either side of the main plate. Butt joints are also further classified according to the number of rivets used and the arrangement of rivets adopted.

1. Double cover single riveted butt joint
2. Double cover chain riveted butt joint
3. Double cover zig-zag riveted butt joint

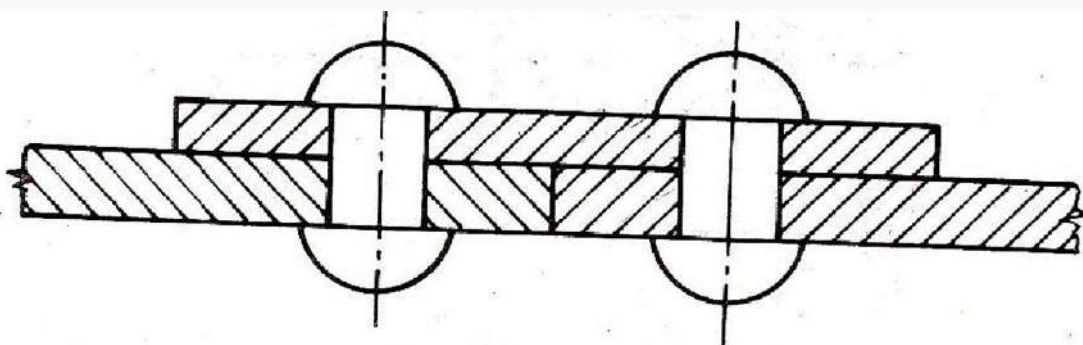

(A) SINGLE COVER PLATE BUTT-JOINT

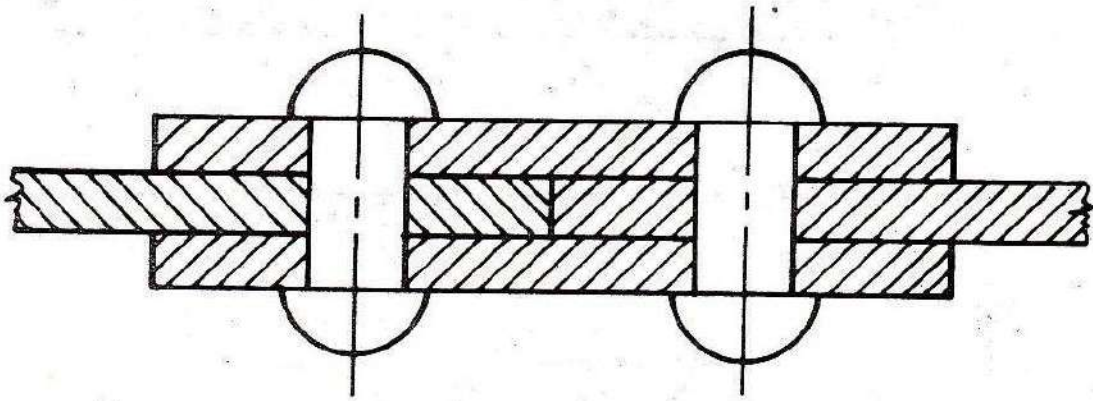

**DOUBLE COVER SINGLE RIVETED BUTT JOINT**

#### FAILURE OF A RIVETED JOINT

Failure of a riveted joint may take place in any of the following ways

1. Shear failure of rivets
2. Bearing failure of rivets
3. Tearing failure of plates
4. Shear failure of plates
5. Bearing failure of plates
6. Splitting/cracking failure of plates at the edges

#### **Tearing failure of plates :**

When plates riveted together are carrying tensile load, tearing failure of plate may occur. When strength of the plate is less than that of rivets, tearing failure occurs at the net sectional area of plate.

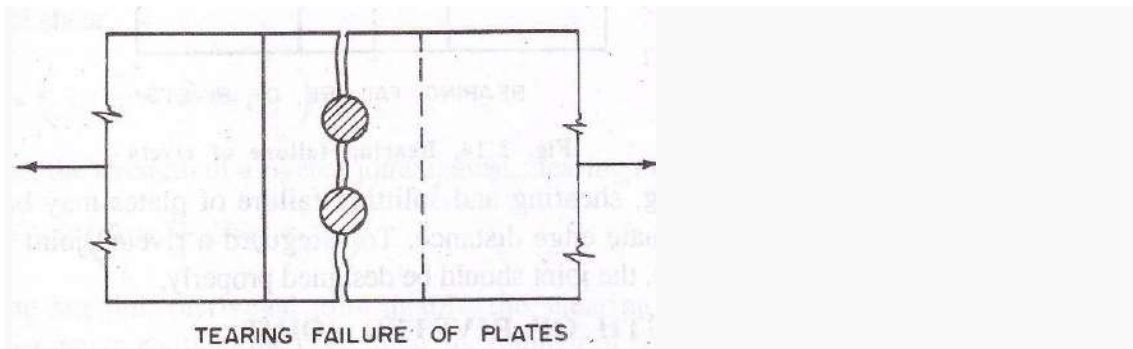

### Shear failure of plates:

A plate may fail in shear along two lines as shown in Fig. This may occur when minimum proper edge distance is not provided.

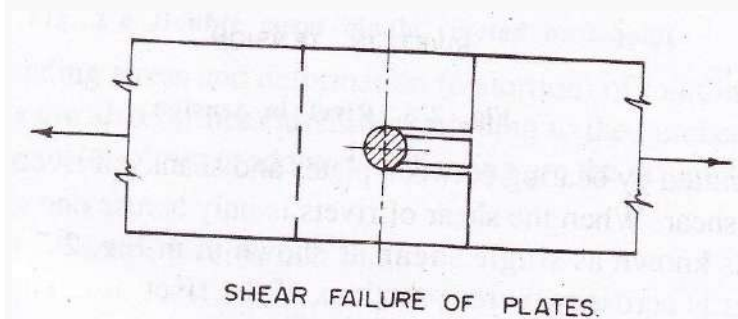

### Bearing failure of plates:

Bearing failure of a plate may occur because of insufficient edge distance in the riveted joint. Crushing of plate against the bearing of rivet take place in such failure.

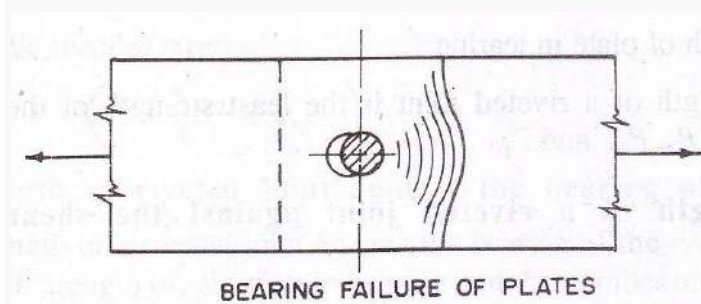

### Splitting/cracking failure of plates at the edges:

This failure occurs because of insufficient edge distance in the riveted joint. Splitting (cracking) of plate as shown in Fig. takes place in such failure.

Shearing, bearing and splitting failure of plates may be avoided by providing adequate proper edge distance. To safeguard a riveted joint against other modes of failure, the joint should be designed properly.



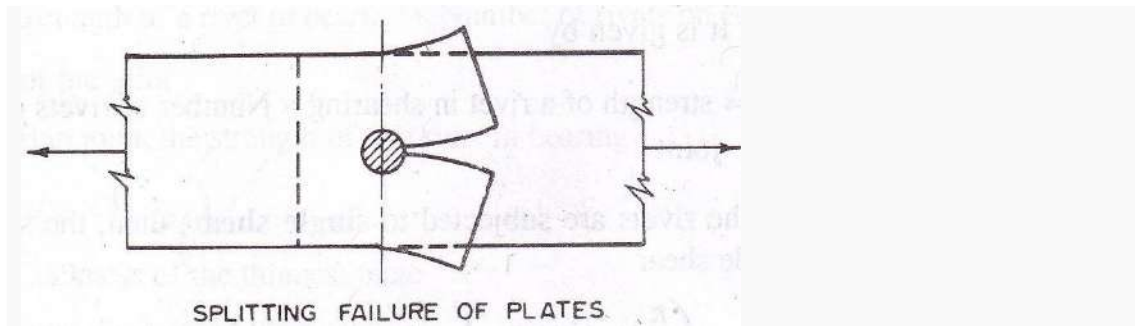

## STRENGTH OF RIVETED JOINT

The strength of a riveted joint is determined by computing the following strengths:

1. Strength of a riveted joint against shearing -  $P_s$
2. Strength of a riveted joint against bearing -  $P_b$
3. Strength of plate in tearing -  $P_t$

The strength of a riveted joint is the least strength of the above three strength.

### Strength of a riveted joint against shearing of the rivets:

The strength of a riveted joint against the shearing of rivets is equal to the product of strength of one rivet in shear and the number of rivets on each side of the joint. It is given by

$P_s = \text{strength of a rivet in shearing} \times \text{number of rivets on each side of joint}$

When the rivets are subjected to single shear, then the strength of one rivet in single shear

$$= \frac{\pi}{4} D^2 p_s$$

$$P_s = N \frac{\pi}{4} D^2 p_s$$

Therefore, the strength of a riveted joint against shearing of rivets =

Where  $N$ =Number of rivets on each side of the joint;  $D$ =Gross diameter of the rivet;  
 $p_s$ =Maximum permissible shear stress in the rivet(1025 ksc).

When the rivets are subjected to double shear, then the strength of one rivet in double shear

$$= 2 \frac{\pi}{4} D^2 p_s$$

Therefore, the strength of a riveted joint against double shearing of rivets,

$$P_s = N \left[ 2 \frac{\pi}{4} D^2 p_s \right]$$

When the strength of riveted joint against the shearing of the rivets is determined per gauge width of the plate, then the number of rivets 'n' per gauge is taken in to consideration. Therefore,

$$\text{For single shear of rivets, } P_{s1} = n \left[ \frac{\pi}{4} D^2 p_s \right]$$

$$\text{For double shear of rivets } P_{s2} = n \left[ 2 \frac{\pi}{4} D^2 p_s \right]$$

### 5.8.2 Strength of riveted joint against the bearing of the rivets:

The strength of a riveted joint against the bearing of the rivets is equal to the product of strength of one rivet in bearing and the number of rivets on each side of the joint. It is given by,

$$P_b = \text{Strength of a rivet in bearing} \times \text{Number of rivets on each side of the joint}$$

In case of lap joint,

the strength of one rivet in bearing =  $D \times t \times p_b$

Where  $D$  = Gross diameter of the rivet;  $t$  = thickness of the thinnest plate;  $p_b$  = maximum permissible stress in the bearing for the rivet (2360 ksc). In case of butt joint, the total thickness of both cover plates or thickness of main plate whichever is less is considered for determining the strength of a rivet in the bearing.

The strength of a riveted joint against the bearing of rivets

$$P_b = N \times D \times t \times p_b$$

When the strength of riveted joint against the bearing of rivets per gauge width of the plate is taken into consideration, then, the number of rivets 'n' is also adopted per gauge. Therefore,

$$P_{b1} = n \times D \times t \times p_b$$

### Strength of plate in tearing

The strength of plate in tearing depends upon the resisting section of the plate. The strength of plate in tearing is given by

$$P_t = \text{Resisting section} \times p_t$$

Where  $p_t$  is the maximum permissible stress in the tearing of plate (1500 ksc). When the strength of plate in tearing per pitch width of the plate is

$$P_{t1} = (p-D) \times t \times p_t$$

The strength of a riveted joint is the least of  $P_s$ ,  $P_b$ ,  $P_t$ . The strength of riveted joint per gauge width of plate is the least of  $P_{s1}$ ,  $P_{b1}$ ,  $P_{t1}$ .

### STRENGTH OF LAP AND BUTT JOINT

The strength of riveted lap and butt joint given in the Fig. is summarized as follows:

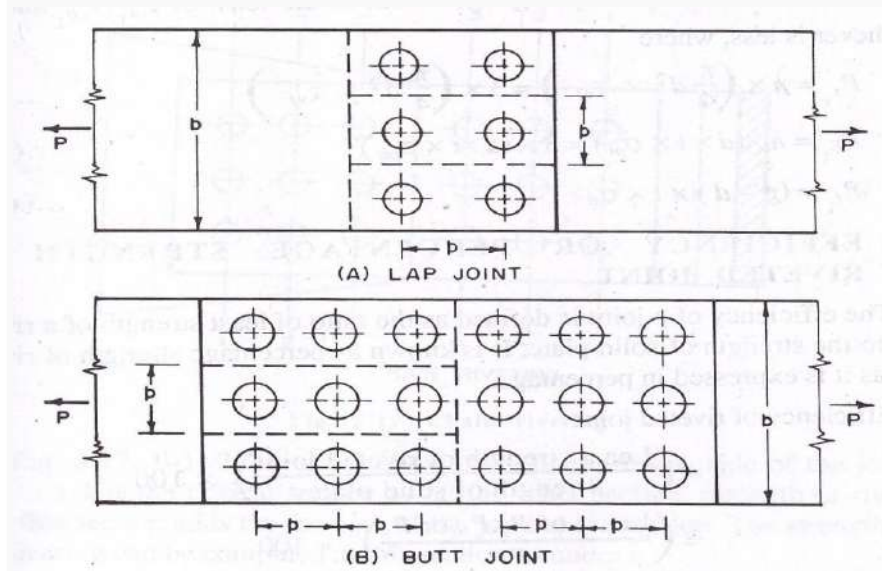

#### 5.9.1 Strength of lap joint:

1. Strength of riveted joint against shearing  $P_s = 6 \frac{\pi}{4} D^2 p_s$
2. Strength of riveted joint against bearing  $P_b = 6 \times D \times t \times p_b$
3. Strength of riveted joint against tearing  $P_t = (b-3D) \times t \times p_t$
4. Strength of riveted joint against shearing per gauge width  $P_{s1} = 2 \frac{\pi}{4} D^2 p_s$
5. Strength of riveted joint against bearing per gauge width  $P_{b1} = 2 \times D \times t \times p_b$
6. Strength of riveted joint against tearing per gauge width  $P_{t1} = (p-D) \times t \times p_t$

### Strength of butt joint:

1. Strength of riveted joint against shearing  $P_s = 9 \times 2 \times \frac{\pi}{4} \times D^2 \times p_s$
2. Strength of riveted joint against bearing  $P_b = 9 \times D \times t \times p_b$
3. Strength of riveted joint against tearing  $P_t = (b-3D) \times t \times p_t$
4. Strength of riveted joint against shearing per gauge width  $P_{s1} = 3 \times 2 \times \frac{\pi}{4} \times D^2 \times p_s$
5. Strength of riveted joint against bearing per gauge width  $P_{b1} = 3 \times D \times t \times p_b$
6. Strength of riveted joint against tearing per gauge width  $P_{t1} = (p-D) \times t \times p_t$

### EFFICIENCY OR PERCENTAGE OF STRENGTH OF RIVETED JOINT

The efficiency of a joint is defined as the ratio of least strength of a riveted joint to the strength of solid plate. It is known as percentage strength of riveted joint as it is expressed in percentage.

Efficiency of riveted joint

$$\eta = \frac{\text{Least strength of riveted joint}}{\text{Strength of solid plate}} \times 100$$

$$\eta = \frac{\text{Least of } P_s, P_b \text{ or } P_t}{P} \times 100$$

Where P is the strength of solid plate =  $b \times t \times p_t$

Efficiency per pitch width

$$\begin{aligned} &= \frac{(p-D) \times t \times p_t}{p \times t \times p_t} \times 100 \\ &= \frac{(p-D)}{p} \times 100 \end{aligned}$$

### RIVET VALUE

The strength of a rivet in shearing and in bearing is computed and the lesser is called the rivet value (R).

## Bolted connections

### Connection classification

**(a) Classification based on the type of resultant force transferred:** The bolted connections are referred to as concentric connections (force transfer in tension and compression member), eccentric connections (in reaction transferring brackets) or moment resisting connections (in beam to column connections in frames).

Ideal concentric connections should have only one bolt passing through all the members meeting at a joint. However, in practice, this is not usually possible and so it is only ensured that the centroidal axes of the members meet at one point. The Moment connections are more complex to analyse compared to the above two types. The connection is also known as bracket connection and the resistance is only through shear in the bolts.

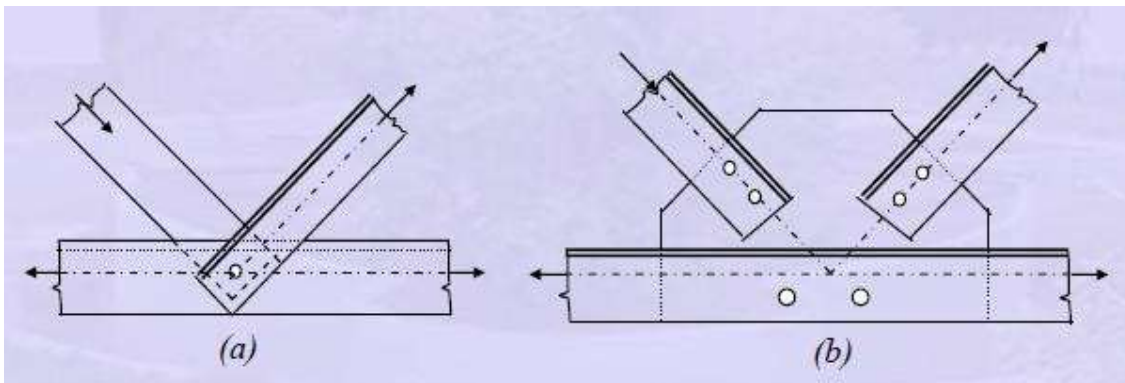

### Concentric connections

The connection shown in Fig. is often found in moment resisting frames where the beam moment is transferred to the column. The connection is also used at the base of the column where a base plate is connected to the foundation by means of anchor bolts. In this connection, the bolts are subjected to a combination of shear and axial tension.

**(b) Classification based on the type of force experienced by the bolts:** The bolted connections can also be classified based on geometry and loading conditions into three types namely, shear connections, tension connections and combined shear and tension connections.

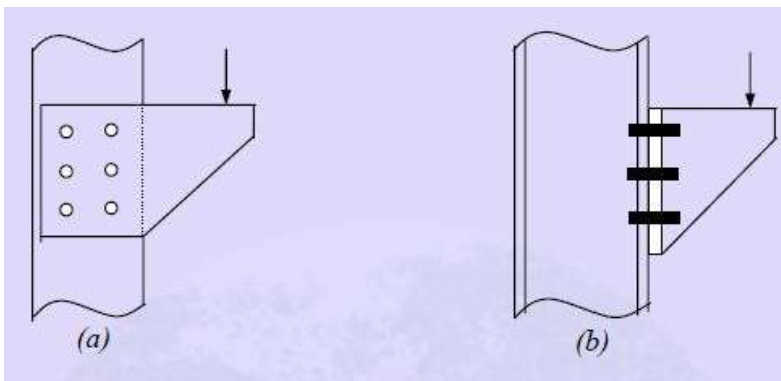

### Moment connections

Typical shear connections occur as a *lap* or a *butt* joint used in the tension members. While the lap joint has a tendency to bend so that the forces tend to become collinear, the butt joint requires *cover plates*. Since the load acts in the plane of the plates, the load transmission at the joint will ultimately be through shearing forces in the bolts.

In the case of lap joint or a single cover plate butt joint, there is only one shearing plane, and so the bolts are said to be in *single shear*. In the case of double cover butt joint, there are two shearing planes and so the bolts will be in *double shear*. It should be noted that the single cover type butt joint is nothing but lap joints in series and also bends so that the centre of the cover plate becomes collinear with the forces. In the case of single cover plate (lap) joint, the thickness of the cover plate is chosen to be equal to or greater than the connected plates. While in double cover plate (butt) joint, the combined thickness of the cover plates should be equal to or greater than the connected plates.

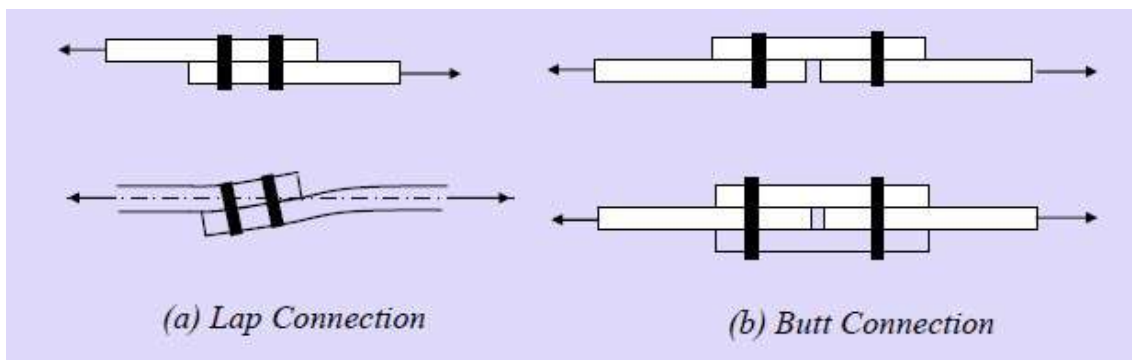

### Shear connections

A hanger connection is shown in Fig.(a) In this connection, load transmission is by pure tension in the bolts. In the connection shown in Fig. (b), the bolts are subjected to both tension and shear.

**(c) Classification based on force transfer mechanism by bolts:** The bolted connections are classified as bearing type (bolts bear against the holes to transfer the force) or friction type (force transfer between the plates due to the clamping force generated by the pre-tensioning of the bolts). The force transfer in either case is discussed in more detail later.

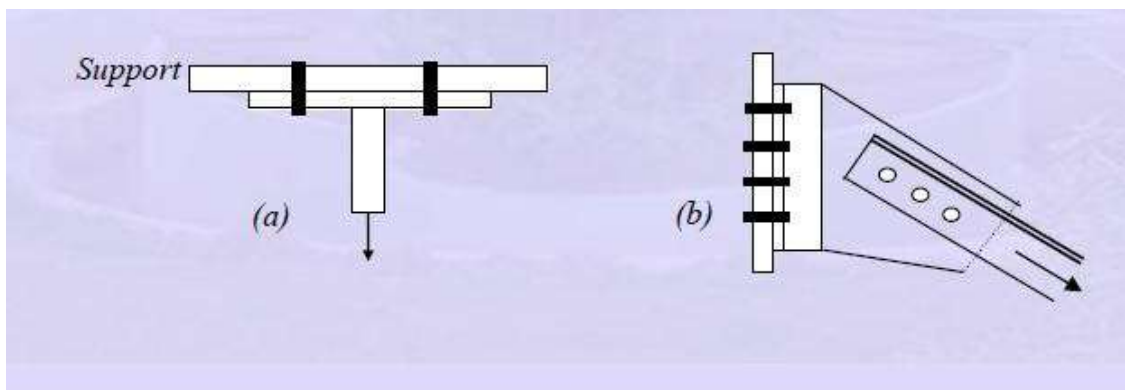

(a) Tension connection (b) Tension plus shear connection

## Bolts and bolting

Bolts used in steel structures are of three types:

- 1) Black Bolts
- 2) Turned and Fitted Bolts and
- 3) High Strength Friction Grip (HSFG) Bolts.

The International Standards Organisation designation for bolts, also followed in India, is given by Grade  $x.y$ . In this nomenclature,  $x$  indicates one-tenth of the minimum ultimate tensile strength of the bolt in  $\text{kgf/mm}^2$  and the second number,  $y$ , indicates one tenth of the ratio of the yield stress to ultimate stress, expressed as a percentage. Thus, for example, grade 4.6 bolt will have a minimum ultimate strength  $40 \text{ kgf/mm}^2$  ( $392 \text{ Mpa}$ ) and minimum yield strength of 0.6 times 40, which is  $24 \text{ kgf/mm}^2$  ( $235 \text{ Mpa}$ ).

*Black bolts* are unfinished and are made of mild steel and are usually of Grade 4.6. Black bolts have adequate strength and ductility when used properly; but while tightening the nut snug tight ("Snug tight" is defined as the tightness that exists when all plies in a joint are in firm contact) will twist off easily if tightened too much. Turned -and fitted bolts have uniform shanks and are inserted in close tolerance drilled holes and made snug tight by box spanners. The diameter of the hole is about 1.5 to 2.0 mm larger than the bolt diameter for ease in fitting. High strength black bolts (grade 8.8) may also be used in connections in which the bolts are tightened snug fit.

In these *bearing type of connections*, the plates are in firm contact but may slip under loading until the hole surface bears against the bolt. The load transmitted from plate to bolt is therefore by bearing and the bolt is in shear as explained in the next section. Under dynamic loads, the nuts are liable to become loose and so these bolts are not allowed for use under such loading. In situations where small slips can cause significant effects as in beam splices, black bolts are not preferred. However, due to the lower cost of the bolt and its installation, black bolts are quite popular in simple structures subjected to static loading.

Turned and fitted bolts are available from grade 4.6 to grade 8.8. For the higher grades there is no definite yield point and so 0.2% proof stress is used.

*High Strength Friction Grip bolts (HSFG)* provide extremely efficient connections and perform well under fluctuating/fatigue load conditions. These bolts should be tightened to their **proof loads** and require hardened washers to distribute the load under the bolt heads. The washers are usually tapered when used on rolled steel sections. The tension in the bolt ensures that no slip takes place under working conditions and so the load transmission from plate to the bolt is through friction and not by bearing as explained in the next section. However, under ultimate load, the friction may be overcome leading to a slip and so bearing will govern the design.

HSFG bolts are made from quenched and tempered alloy steels with grades from 8.8 to 10.9. The most common are the so-called, general grade of 8.8 and have medium carbon content, which makes them less ductile. The 10.9 grade have a much higher tensile strength, but lower ductility and the margin between the 0.2% yield strength and the ultimate strength is also lower.

The tightening of HSFG bolts can be done by either of the following methods (IS 4000-..):

1. *Turn-of-nut tightening method*: In this method the bolts are first made **snug tight** and then turned by specific amounts (usually either half or three-fourth turns) to induce tension equal to the proof load.
2. *Calibrated wrench tightening method*: In this method the bolts are tightened by a wrench calibrated to produce the required tension.
3. *Alternate design bolt installation*: In this method special bolts are used which indicate the bolt tension. Presently such bolts are not available in India.
4. *Direct tension indicator method*: In this method special washers with protrusions are used. As the bolt is tightened, these protrusions are compressed and the gap produced by them gets reduced in proportion to the load. This gap is measured by means of a feeler gauge, consisting of small bits of steel plates of varying thickness, which can be inserted into the gap.

Since HSFG bolts under working loads, do not rely on resistance from bearing, holes larger than usual can be provided to ease erection and take care of lack-of-fit. Typical hole types that can be used are standard, extra large and short or long slotted. However the type of hole will govern the strength of the connection.

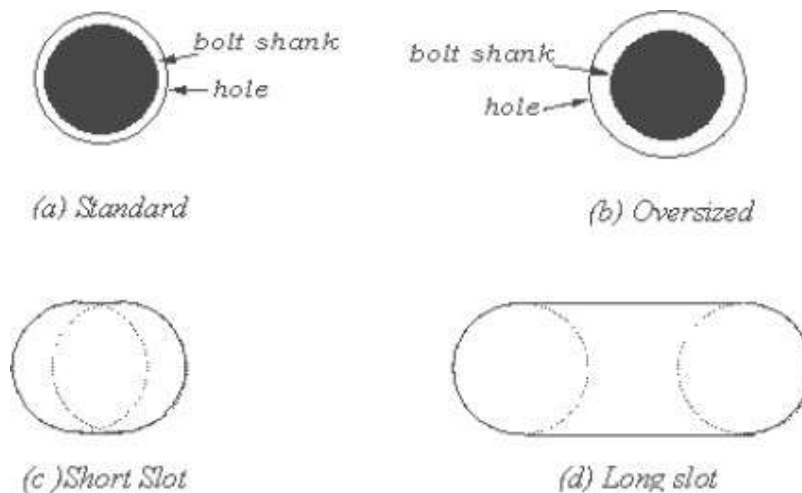

*Hole types for HSFG bolts*

### **Force transfer of bearing type bolts**

Fig. shows the free body diagram of the shear force transfer in bearing type of bolted connection. It is seen that tension in one plate is equilibrated by the bearing stress between the bolt and the hole in the plate. Since there is a clearance between the bolt and the hole in which it is fitted, the bearing stress is mobilised only after the plates slip relative to one another and start bearing on the bolt. The section x-x in the bolt is critical section for shear. Since it is a lap joint there is only one critical section in shear (single shear) in the bolt. In the case of butt splices there would be two critical sections in the bolt in shear (double shear), corresponding to the two cover plates.



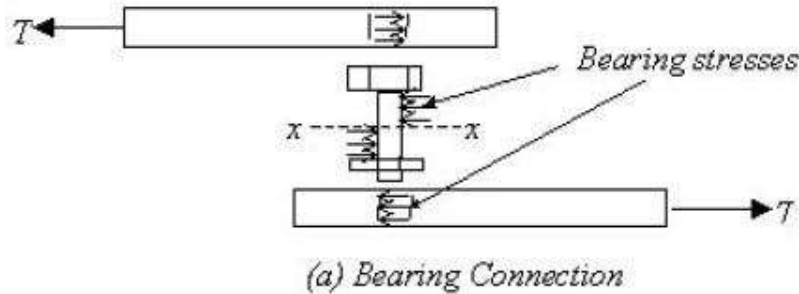

### Shear transfer by bearing type bolt

#### Design shear strength of bearing type bolts

The failure of connections with bearing bolts in shear involves either bolt failure or the failure of the connected plates. In this section, the failure modes are described along with the codal provisions for design and detailing shear connections.

In connections made with bearing type of bolts, the behaviour is linear until i) yielding takes place at the net section of the plate under combined tension and flexure or ii) shearing takes place at the bolt shear plane or iii) failure of bolt takes place in bearing, iv) failure of plate takes place in bearing and v) block shear failure occurs.

**1. Shearing of bolts:** The shearing of bolts can take place in the threaded portion of the bolt and so the area at the root of the threads, also called the tensile stress area  $A_t$ , is taken as the shear area  $A_s$ . Since threads can occur in the shear plane, the area  $A_e$  for resisting shear should normally be taken as the net tensile stress area,  $A_n$ , of the bolts. The shear area is specified in the code and is usually about 0.8 times the shank area. However, if it is ensured that the threads will not lie in the shear plane then the full area can be taken as the shear area. A bolt subjected to a factored shear force ( $V_{sb}$ ) shall satisfy

$$V_{sb} < V_{nsb} / \gamma_{mb}$$

Where

$V_{nsb}$  = nominal shear capacity of a bolt, calculated as follows:

$$\gamma_{mb} = 1.25$$

$$V_{nsb} = \frac{f_u}{\sqrt{3}} (n_n A_{nb} + n_s A_{sb})$$

Where

$f_u$  = ultimate tensile strength of a bolt

$n_n$  = number of shear planes with threads intercepting the shear plane

$n_s$  = number of shear planes without threads intercepting the shear plane

$A_{sb}$  = nominal plain shank area of the bolt

$A_{nb}$  = net tensile area at threads, may be taken as the area corresponding to root diameter at the thread

**2. Bearing failure:** If the connected plates are made of high strength steel then failure of bolt can take place by bearing of the plates on the bolts. If the plate material is weaker than the bolt material, then failure will occur by bearing of the bolt on the plate and the hole will elongate. The bearing area is given by the nominal diameter of the bolt times the combined thickness of the plates bearing in any direction. – A bolt bearing on any plate subjected to a factored shear force ( $V_{sb}$ ) shall satisfy

$$V_{sb} \leq V_{npb} / \gamma_{mb}$$

Where,  $\gamma_{mb} = 1.25$

$V_{npb}$  = bearing strength of a bolt, calculated as

$$V_{npb} = 2.5dtf_u$$

Where

$f_u$  = smaller of the ultimate tensile stress of the bolt and the ultimate tensile stress of the plate

$d$  = nominal diameter of the bolt

$t$  = summation of the thicknesses of the connected plates experiencing bearing stress in the same direction.

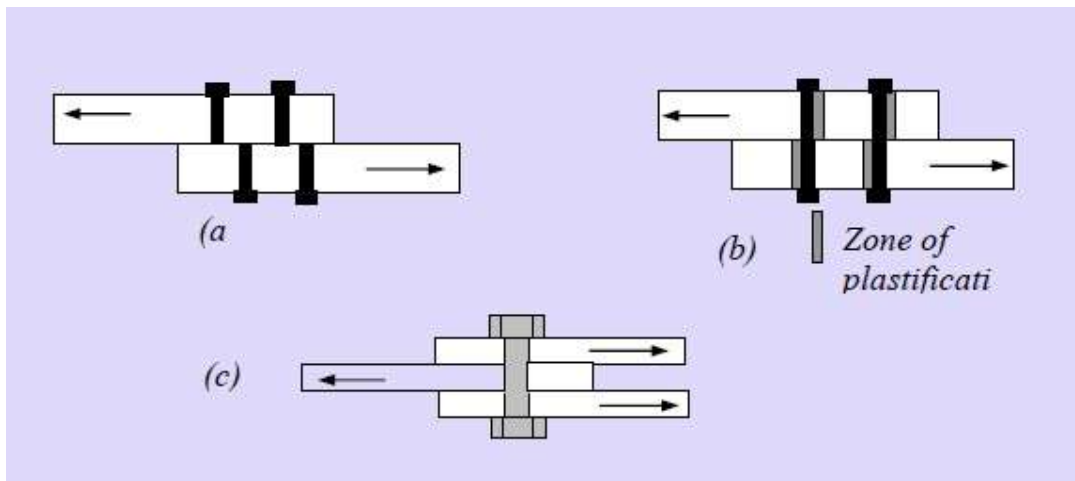

**Types of failures in a shear connection (a) Shearing of bolts (b) Bearing failure of plate (c) Bearing failure of bolt**

The underlying assumption behind the design of bolted connections, namely that all bolts carry equal load is not true in some cases as mentioned below.

In long joints, the bolts farther away from the centre of the joint will carry more load than the bolts located close to the centre. Therefore, for joints having more than two bolts on either side of the building connection with the distance between the first and the last bolt exceeding  $15d$  in the direction of load, the nominal shear capacity  $V_{ns}$ , shall be reduced by the factor,  $\beta_{lj}$ , given by (Cl.10.3.2.1)

$$\beta_{lj} = 1.075 - l_j / (200d) \text{ but } 0.75 < \beta_{lj} < 1.0$$

Where,  $d$  = nominal diameter of the bolt

Similarly, if the grip length exceeds five times the nominal diameter, the strength is reduced as specified in IS 800. In multibolt connections, due to hole mismatch, all the bolts may not carry the same load. However, under ultimate load, due to high

bearing ductility of the plates considerable redistribution of the load is possible and so the assumption that all bolts carry equal load may be considered valid.

## Shear connection with HSFG bolts

### Force transfer of HSFG bolts

The free body diagram of an HSFG connection is shown in Fig. It can be seen that the pretension in the bolt causes clamping forces between the plates even before the external load is applied. When the external load is applied, the tendency of two plates to slip against one another is resisted by the friction between the plates. The frictional resistance is equal to the coefficient of friction multiplied by the normal clamping force between the plates. Until the externally applied force exceeds this frictional resistance the relative slip between the plates is prevented. The HSFG connections are designed such that under service load the force does not exceed the frictional resistance so that the relative slip is avoided during service. When the external force exceeds the frictional resistance the plates slip until the bolts come into contact with the plate and start bearing against the hole. Beyond this point the external force is resisted by the combined action of the frictional resistance and the bearing resistance.

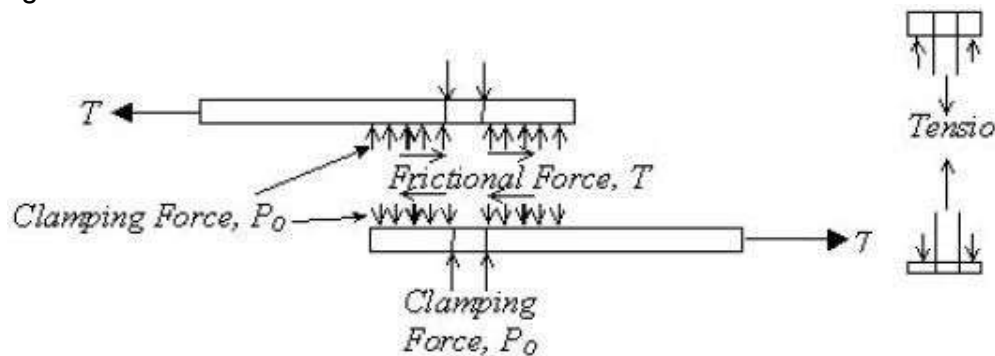

(b) Friction Connection

### Shear transfer by HSFG Bolt

### Design shear strength of HSFG bolts

HSFG bolts will come into bearing only after slip takes place. Therefore if slip is critical (i.e. if slip cannot be allowed) then one has to calculate the slip resistance, which will govern the design. However, if slip is not critical, and limit state method is used then bearing failure can occur at the Limit State of collapse and needs to be checked. Even in the Limit State method, since HSFG bolts are designed to withstand working loads without slipping, the slip resistance needs to be checked anyway as a Serviceability Limit State.

**1. Slip Resistance:** Design for friction type bolting in which slip is required to be limited, a bolt subjected only to a factored design shear force,  $V_{sf}$ , in the interface of connections shall satisfy the following (Cl.10.4.3):

$$V_{sf} < V_{nsf} / \gamma_{mf}$$

Where  $\gamma_{mf} = 1.25$

$V_{nsf}$  = nominal shear capacity of a bolt as governed by slip for friction type connection, calculated as follows:

$$V_{nsf} = \mu_f n_e K_h F_o$$

Where,  $\mu_f$  = coefficient of friction (slip factor) as specified in Table 3.1 ( $\mu_f < 0.55$ )(Table 3.1 of code).

$n_e$  = number of effective interfaces offering frictional resistance to slip

$K_h = 1.0$  for fasteners in clearance holes

= 0.85 for fasteners in oversized and short slotted holes, and for fasteners in long slotted holes loaded perpendicular to the slot

= 0.7 for fasteners in long slotted holes loaded parallel to the slot.

$\gamma_{mf} = 1.10$  (if slip resistance is designed at service load)

$\gamma_{mf} = 1.25$  (if slip resistance is designed at ultimate load)

$F_o$  = minimum bolt tension (proof load) at installation and may be taken as  $0.8 A_{sb}$

$F_o$

$A_{sb}$  = shank area of the bolt in tension

$f_o$  = proof stress (=  $0.70 f_{ub}$ )

$V_{ns}$  may be evaluated at a service load or ultimate load using appropriate partial safety factors, depending upon whether slip resistance is required at service load or ultimate load.

### Typical average values for coefficient of friction ( $\mu_f$ )

Treatment of surface	Coeff. of friction ( $\mu_f$ )
Clean mill scale	0.33
Sand blasted surface	0.48
Surfaces blasted with shot or grit and hot-dip galvanized	0.10

**2. Bearing strength:** The design for friction type bolting, in which bearing stress in the ultimate limit state is required to be limited, ( $V_{ub}$  = factored load bearing force) shall satisfy (Cl.10.4.4)

$$V_{bf} < V_{nbf} / \gamma_{mf}$$

Where  $\gamma_{mf} = 1.25$

$V_{nbf}$  = bearing capacity of a bolt, for friction type connection, calculated as follows:

$$V_{nbf} = 2.2 d t f_{up} < 3 d t f_{yp}$$

Where

$f_{up}$  = ultimate tensile stress of the plate

$f_{yp}$  = tensile yield stress of the plate

$d$  = nominal diameter of the bolt

$t$  = summation of thicknesses of all the connected plates experiencing bearing stress in the same direction

The block shear resistance of the edge distance due to bearing force shall also be checked.

## Tension connections with bearing and HSFG bolts

### Force transfer by bearing and HSFG bolts

The free body diagram of the tension transfer in a bearing type of bolted connection is shown in Fig. The variation of bolt tension due to externally applied tension is

shown in Fig. It is seen that before any external tension is applied, the force in the bolt is almost zero, since the bolts are only snug tight. As the external tension is increased it is equilibrated by the increase in bolt tension. Failure is reached due to large elongation when the root of the bolt starts yielding. Depending on the relative flexibility of the plate and the bolt, sometimes the opening of the joint may be accompanied by prying action.

The free body diagram of an HSFG bolted connection is shown in Fig. It is seen that even before any external load is applied, the force in the bolt is equal to proof load. Correspondingly there is a clamping force between the plates in contact.

When the external load is applied, part of the load (nearly 10%) of the load is equilibrated by the increase in the bolt force. The balance of the force is equilibrated by the reduction in contact between the plates. This process continues and the contact between the plates is maintained until the contact force due to pre-tensioning is reduced to zero by the externally applied load. Normally, the design is done such that the externally applied tension does not exceed this level. After the external force exceeds this level, the behaviour of the bolt under tension is essentially the same as that in a bearing type of joint.

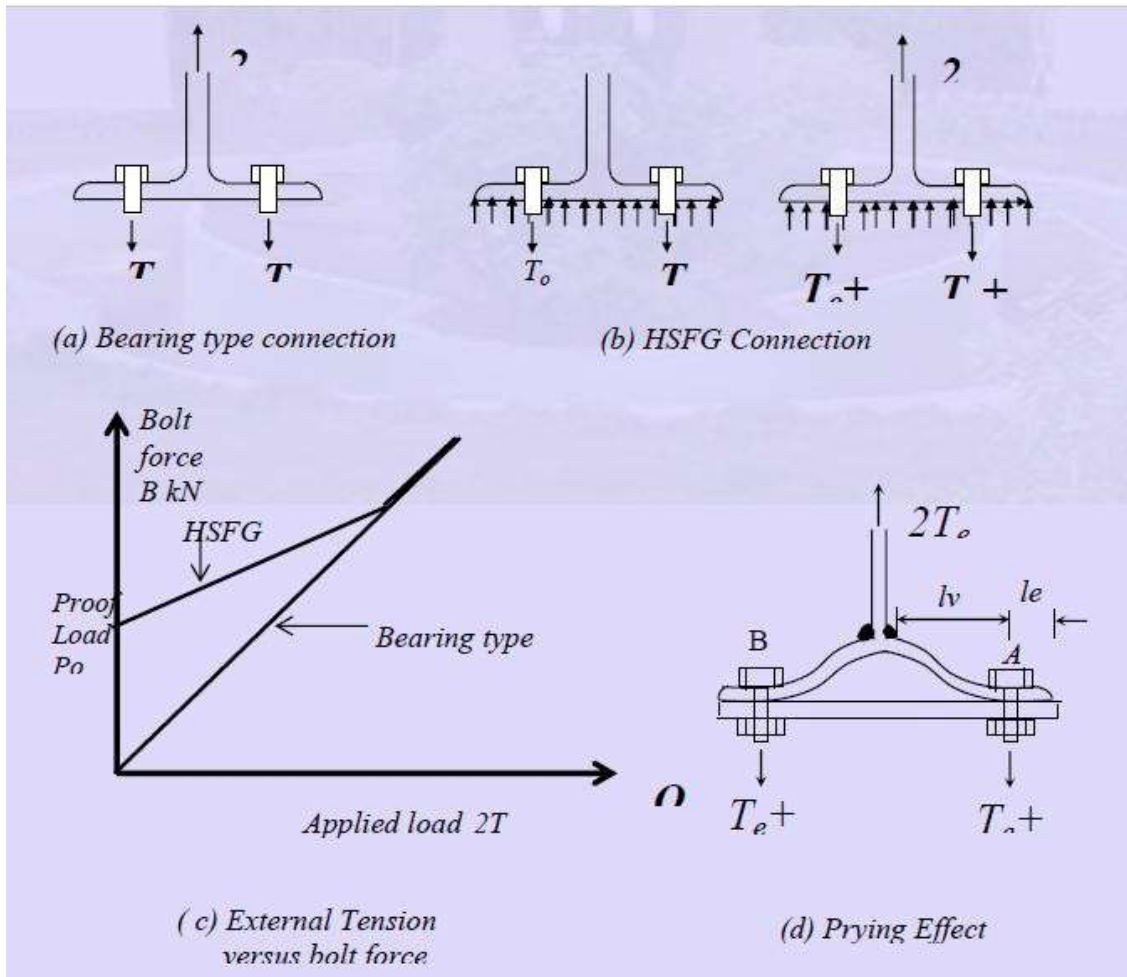

### Bolts under tension and prying effect

Where prying force,  $Q$ , is significant, prying force shall be calculated as given below and added to the tension in the bolt (Cl.10.4.7).

$$Q = \frac{l_v}{2 l_e} \left[ T_e - \frac{\beta \gamma f_o b_e t^4}{27 l_e l_v^2} \right]$$

Where,  $l_v$  = distance from the bolt centreline to the toe of the fillet weld or to half the root radius for a rolled section;  $l_e$  = distance between prying force and bolt centreline and is the minimum of, either the end distance, or the value given by

$$l_e = 1.1 t \sqrt{\frac{\beta f_o}{f_y}}$$

Where,

$\beta$  = 2 for non pre-tensioned bolt and 1 for pre-tensioned bolt

$\gamma$  = 1.5

$b_e$  = effective width of flange per pair of bolts

$f_o$  = proof stress in consistent units

$t$  = thickness of the end plate

Even if the bolts are strong enough to carry the additional prying forces, the plate can fail by developing a mechanism with yield lines at the centreline of the bolt and at the distance  $b$  from it. Therefore, the minimum thickness of the end plate ( $t$ ), to avoid yielding of the plate, can be obtained by equating the moment in the plate at the bolt centreline (point A) and at the distance  $b$  from it (point B), to the plastic moment capacity of the plate  $M_p$ . Thus,

$$M_A = Qn; \quad M_B = Tb - Qn$$

$$M_A = M_B = \frac{Tb}{2} = M_p$$

taking  $M_p$  as

$$M_p = \frac{f_y w t^2}{1.15 \times 4}$$

the minimum thickness for the end plate can be obtained as

$$t_{\min} = \sqrt{\frac{1.15 \times 4 \times M_p}{f_y \times w}}$$

The corresponding prying force can then be obtained as

$$Q = M_p/n.$$

If the total force in the bolt ( $T+Q$ ) exceeds the tensile capacity of the bolt, then the thickness of the end plate will have to be increased.

### Design tensile strength of bearing and HSFG bolts

In a tension or hanger connection, the applied load produces tension in the bolts and the bolts are designed as tension members. If the attached plate is allowed to deform, additional tensile forces called prying forces are developed in the bolts.

*Tension Capacity* – A bolt subjected to a factored tension force ( $T_b$ ) shall satisfy (Cl.10.3.4)

$$T_b < T_{nb} / \gamma_{mb} \quad \gamma_{mb} = 1.25$$

Where,  $T_{nb}$  = nominal tensile capacity of the bolt, calculated as follows:

$$T_{nb} = 0.90 f_{ub} A_n < f_{yb} A_{sb} (\gamma_{m1} / \gamma_{m0}) \quad \gamma_{m0} = 1.10 \text{ and } \gamma_{m1} = 1.25$$

Where,

$f_{ub}$  = ultimate tensile stress of the bolt

$f_{yb}$  = yield stress of the bolt

$A_n$  = net tensile stress area as specified in the appropriate Indian Standard. For bolts where the tensile stress area is not defined,  $A_n$  shall be taken as the area at the root of the threads

$A_{sb}$  = shank area of the bolt.

### Combined shear and tension failure

*Bolt Subjected to Combined Shear and Tension* – A bolt required to resist both design shear force ( $V_{sd}$ ) and design tensile force ( $T_{nd}$ ) at the same time shall satisfy

$$\left( \frac{V}{V_{sd}} \right)^2 + \left( \frac{T_e}{T_{nd}} \right)^2 \leq 1.0$$

Where,  $V$  = applied shear;  $V_{sd}$  = design shear capacity;  $T_e$  = externally applied tension and  $T_{nd}$  = design tension capacity. This gives a circular interaction curve as shown in Fig.

Bolts in a connection for which slip in the serviceability limit state shall be limited, which are subjected to a tension force,  $T$ , and shear force,  $V$ , shall satisfy (Cl.10.4.6)

$$\left( \frac{V}{V_{sdf}} \right)^2 + \left( \frac{T}{T_{ndf}} \right)^2 \leq 1.0$$

Where,  $V$  = applied shear at service load;  $V_{sdf}$  = design shear strength;  $T_e$  = externally applied tension at service load;  $T_{ndf}$  = design tension strength.

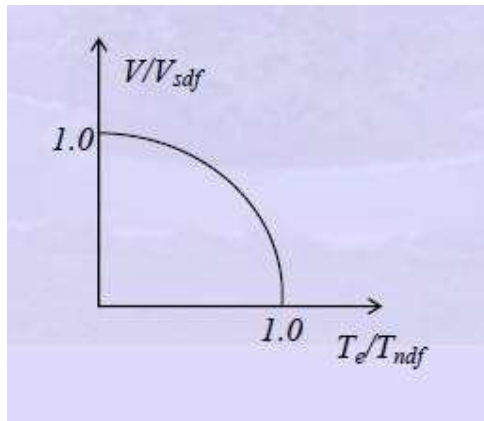

**Shear and Tension Interaction Curve**

## **Welding and welded connections**

Welding is the process of joining two pieces of metal by creating a strong metallurgical bond between them by heating or pressure or both. It is distinguished from other forms of mechanical connections, such as riveting or bolting, which are formed by friction or mechanical interlocking. It is one of the oldest and reliable methods of joining.

Welding offers many advantages over bolting and riveting. Welding enables direct transfer of stress between members eliminating gusset and splice plates necessary for bolted structures. Hence, the weight of the joint is minimum. In the case of tension members, the absence of holes improves the efficiency of the section. It involves less fabrication cost compared to other methods due to handling of fewer parts and elimination of operations like drilling, punching etc. and consequently less labour leading to economy. Welding offers air tight and water tight joining and hence is ideal for oil storage tanks, ships etc. Welded structures also have a neat appearance and enable the connection of complicated shapes. Welded structures are more rigid compared to structures with riveted and bolted connections. A truly continuous structure is formed by the process of fusing the members together. Generally welded joints are as strong or stronger than the base metal, thereby placing no restriction on the joints. **Stress concentration effect** is also considerably less in a welded connection.

Some of the disadvantages of welding are that it requires skilled manpower for welding as well as inspection. Also, non-destructive evaluation may have to be carried out to detect defects in welds. Welding in the field may be difficult due to the location or environment. Welded joints are highly prone to cracking under fatigue loading. Large **residual stresses** and **distortion** are developed in welded connections.

### **3.3.1 Fundamentals of welding**

A welded joint is obtained when two clean surfaces are brought into contact with each other and either pressure or heat, or both are applied to obtain a bond. The tendency of atoms to bond is the fundamental basis of welding. The inter-diffusion between the materials that are joined is the underlying principle in all welding



processes. The diffusion may take place in the liquid, solid or mixed state. In welding the metallic materials are joined by the formation of metallic bonds and a perfect connection is formed. In practice however, it is very difficult to achieve a perfect joint; for, real surfaces are never smooth. When welding, contact is established only at a few points in the surface, joins irregular surfaces where atomic bonding occurs. Therefore the strength attained will be only a fraction of the full strength. Also, the irregular surface may not be very clean, being contaminated with adsorbed moisture, oxide film, grease layer etc. In the welding of such surfaces, the contaminants have to be removed for the bonding of the surface atoms to take place. This can be accomplished by applying either heat or pressure. In practical welding, both heat and pressure are applied to get a good joint.

As pointed out earlier, any welding process needs some form of energy, often heat, to connect the two materials. The relative amount of heat and pressure required to join two materials may vary considerably between two extreme cases in which either heat or pressure alone is applied. When heat alone is applied to make the joint, pressure is used merely to keep the joining members together. Examples of such a process are Gas Tungsten Arc Welding (GTAW), Shielded Metal Arc Welding (SMAW), Submerged Arc Welding (SAW) etc. On the other hand pressure alone is used to make the bonding by plastic deformation, examples being cold welding, roll welding, ultrasonic welding etc. There are other welding methods where both pressure and heat are employed, such as resistance welding, friction welding etc. A flame, an arc or resistance to an electric current, produces the required heat. Electric arc is by far the most popular source of heat used in commercial welding practice.

## **Welding process**

In general, gas and arc welding are employed; but, almost all structural welding is arc welding. In gas welding a mixture of oxygen and some suitable gas is burned at the tip of a torch held in the welder's hand or by an automatic machine. Acetylene is the gas used in structural welding and the process is called oxyacetylene welding. The flame produced can be used both for cutting and welding of metals. Gas welding is a simple and inexpensive process. But, the process is slow compared to other means of welding.

It is generally used for repair and maintenance work.

The most common welding processes, especially for structural steel, use electric energy as the heat source produced by the electric arc. In this process, the base metal and the welding rod are heated to the fusion temperature by an electric arc. The arc is a continuous spark formed when a large current at a low voltage is discharged between the electrode and the base metal through a thermally ionised gaseous column, called plasma. The resistance of the air or gas between the electrode and the objects being welded changes the electric energy into heat. A temperature of 3300°C to 5500°C

is produced in the arc. The welding rod is connected to one terminal of the current source and the object to be welded to the other. In arc welding, fusion takes place by the flow of material from the welding rod across the arc without pressure being applied.

The Shielded Metal Arc Welding process is explained in the following paragraph.

In Shielded Metal Arc Welding or SMAW (Fig.3.12), heating is done by means of electric arc between a coated electrode and the material being joined. In case bare wire electrode (without coating) is employed, the molten metal gets exposed to atmosphere and combines chemically with oxygen and nitrogen forming defective

welds. The electrode coating on the welding rod forms a gaseous shield that helps to exclude oxygen and stabilise the arc.

The coated electrode also deposits a slag in the molten metal, which because of its lesser density compared to the base metal, floats on the surface of the molten metal pool, shields it from atmosphere, and slows cooling. After cooling, the slag can be easily removed by hammering and wire brushing. The coating on the electrode thus: shields the arc from atmosphere; coats the molten metal pool against oxidation; stabilises the arc; shapes the molten metal by surface tension and provides alloying element to weld metal.

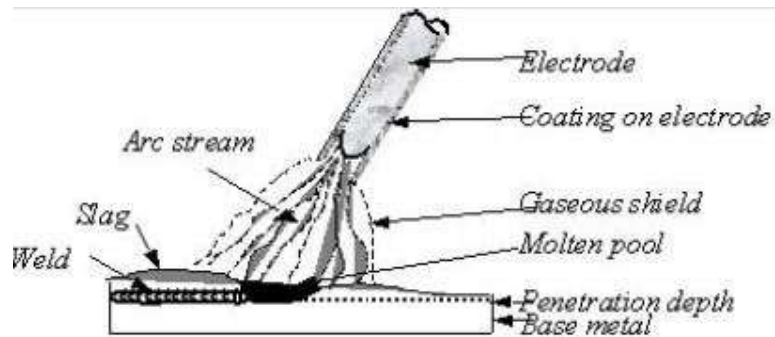

### Shielded metal arc welding (SMAW) process

The type of welding electrode used would decide the weld properties such as strength, ductility and corrosion resistance. The type to be used for a particular job depends upon the type of metal being welded, the amount of material to be added and the position of the work. The two general classes of electrodes are lightly coated and heavily coated. The heavily coated electrodes are normally used in structural welding.

The resulting welds are stronger, more corrosion resistant and more ductile compared to welds produced by lightly coated electrodes. Usually the SMAW process is either automatic or semi-automatic.

The term weldability is defined as the ability to obtain economic welds, which are good, crack-free and would meet all the requirements. Of great importance are the chemistry and the structure of the base metal and the weld metal. The effects of heating and cooling associated with fusion welding are experienced by the weld metal and the

Heat Affected Zone (HAZ) of the base metal. The cracks in HAZ are mainly caused by high carbon content, hydrogen embrittlement and rate of cooling. For most steels, weld cracks become a problem as the thickness of the plates increases.

### Types of joints and welds

By means of welding, it is possible to make continuous, load bearing joints between the members of a structure. A variety of joints is used in structural steel work and they can be classified into four basic configurations namely, Lap joint, Tee joint, Butt joint and Corner joint.

For lap joints, the ends of two members are overlapped and for butt joints, the two members are placed end to end. The T- joints form a Tee and in Corner joints, the ends are joined like the letter L. Most common joints are made up of fillet weld or the butt (also calling groove) weld. Plug and slot welds are not generally used in

structural steel work. Fig. Fillet welds are suitable for lap joints and Tee joints and groove welds for butt and corner joints. Butt welds can be of complete penetration or incomplete penetration depending upon whether the penetration is complete through the thickness or partial. Generally a description of welded joints requires an indication of the type of both the joint and the weld.

Though fillet welds are weaker than butt welds, about 80% of the connections are made with fillet welds. The reason for the wider use of fillet welds is that in the case of fillet welds, when members are lapped over each other, large tolerances are allowed in erection. For butt welds, the members to be connected have to fit perfectly when they are lined up for welding. Further butt welding requires the shaping of the surfaces to be joined as shown in Fig. To ensure full penetration and a sound weld, a backup plate is temporarily provided as shown in Fig.

### Butt welds:

Full penetration butt welds are formed when the parts are connected together within the thickness of the parent metal. For thin parts, it is possible to achieve full penetration of the weld. For thicker parts, edge preparation may have to be done to achieve the welding. There are nine different types of butt joints: square, single V, double V, single U, double U, single J, double J, single bevel and double bevel. They are shown in Fig. 3.13 In order to qualify for a full penetration weld; there are certain conditions to be satisfied while making the welds.

Welds are also classified according to their position into flat, horizontal, vertical and overhead. Flat welds are the most economical to make while overhead welds are the most difficult and expensive.

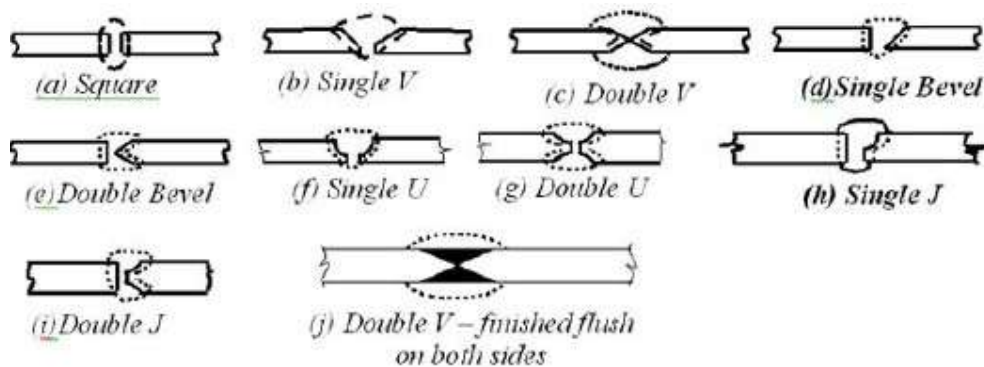

### Different types of butt welds

The main use of butt welds is to connect structural members, which are in the same plane. A few of the many different butt welds are shown in Fig. 3.16. There are many variations of butt welds and each is classified according to its particular shape. Each type of butt weld requires a specific edge preparation and is named accordingly.

The proper selection of a particular type depends upon: Size of the plate to be joined; welding is by hand or automatic; type of welding equipment, whether both sides are accessible and the position of the weld.

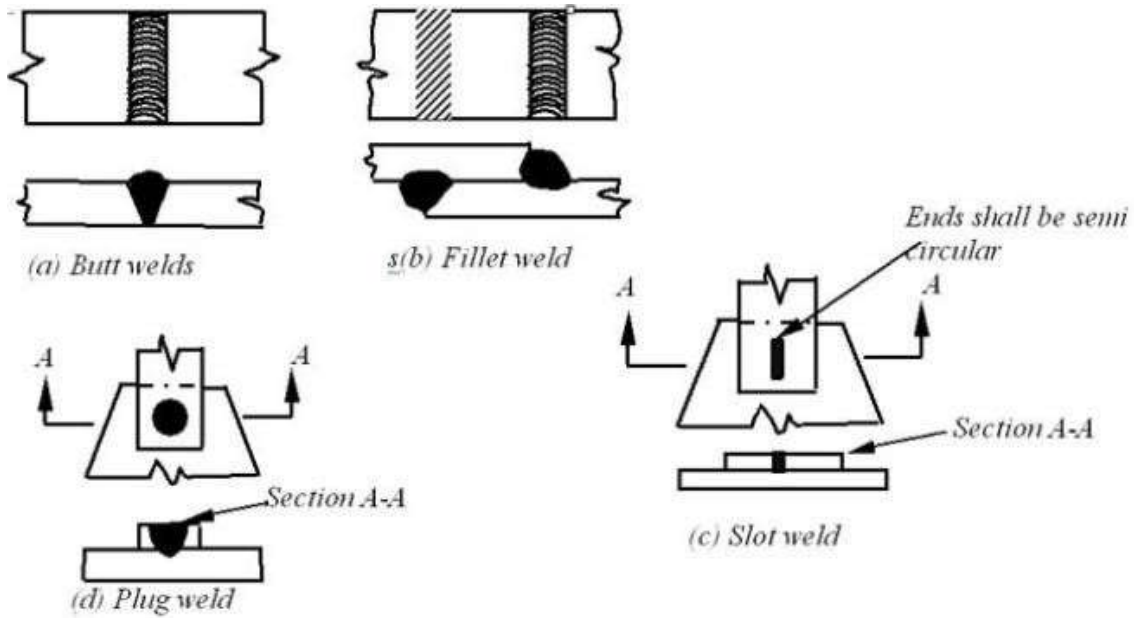

### Common types of welds

To minimise weld distortions and residual stresses, the heat input is minimised and hence the welding volume is minimised. This reduction in the volume of weld also reduces cost. Hence for thicker plates, double Butt welds and U welds are generally used. For a butt weld, the root gap,  $R$ , is the separation of the pieces being joined and is provided for the electrode to access the base of a joint. The smaller the root gap the greater the angle of the bevel. The depth by which the arc melts into the plate is called the depth of penetration [Fig.3.17 (a)]. Roughly, the penetration is about 1 mm per 100A and in manual welding the current is usually 150 – 200 A. Therefore, the mating edges of the plates must be cut back if through-thickness continuity is to be established. This groove is filled with the molten metal from the electrode. The first run that is deposited in the bottom of a groove is termed as the root run [Fig.3.176 (c)]. For good penetration, the root faces must be melted. Simultaneously, the weld pool also must be controlled, preferably, by using a backing strip.

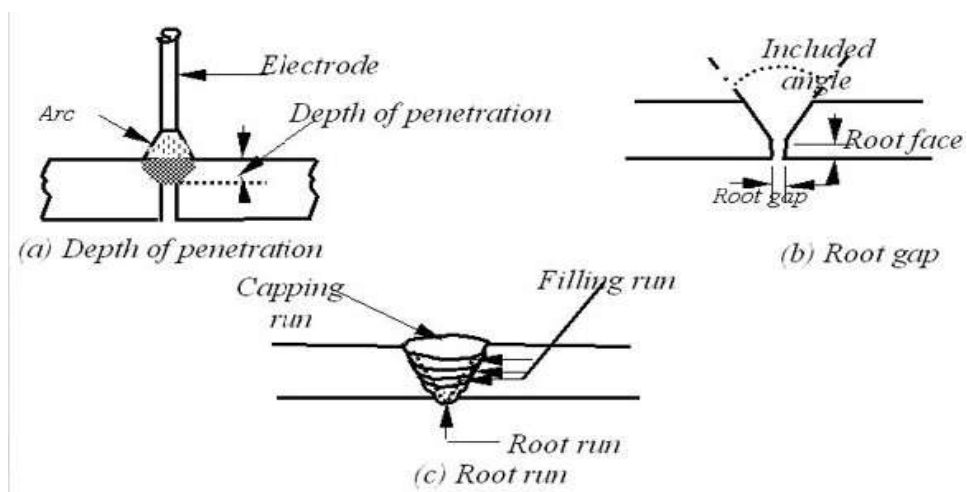

### Butt weld details

## Fillet welds:

Owing to their economy, ease of fabrication and adaptability, fillet welds are widely used. They require less precision in the fitting up because the plates being joined can be moved about more than the Butt welds. Another advantage of fillet welds is that special preparation of edges, as required by Butt welds, is not required. In a fillet weld the stress condition in the weld is quite different from that of the connected parts. A typical fillet weld is shown in Fig.

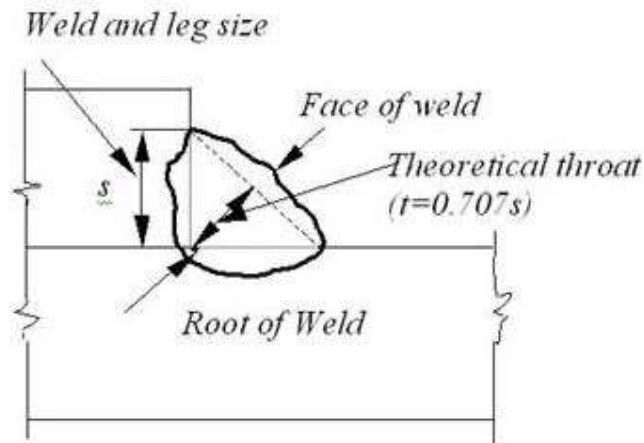

### Typical fillet weld

The root of the weld is the point where the faces of the metallic members meet.











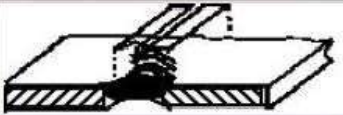



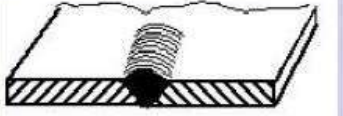









The theoretical throat of a weld is the shortest distance from the root to the hypotenuse of the triangle. The throat area equals the theoretical throat distance times the length of the weld.

The concave shape of free surface provides a smoother transition between the connected parts and hence causes less stress concentration than a convex surface. But it is more vulnerable to shrinkage and cracking than the convex surface and has a much reduced throat area to transfer stresses. On the other hand, convex shapes provide extra weld metal or reinforcement for the throat. For statically loaded structures, a slightly convex shape is preferable, while for fatigue – prone structures, concave surface is desirable.

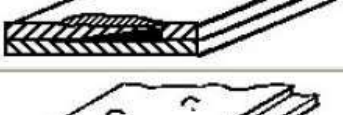
Large welds are invariably made up of a number of layers or passes. For reasons of economy, it is desirable to choose weld sizes that can be made in a single pass.

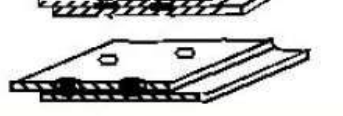
Large welds can be made in a single pass by an automatic machine, though manually, 8 mm fillet is the largest single-pass layer.

Elementary symbols represent the various categories of the weld and look similar to the shape of the weld to be made. Combination of elementary symbols may also be used, when required. Elementary symbols are shown in Table.

Illustration (Fig)	Symbol	Description
		Butt weld between plates with raised edges*(the raised edges being melted down completely)
		Square butt weld
		Single-V butt weld
		Single-bevel butt weld
		Single - V butt weld with broad root face
		Single - bevel butt weld with broad root face
		Single - J butt joint
		Backing run; back or backing weld
		Fillet weld
		Plug weld; plug or slot weld
		Spot weld
		Seam weld

## Design of welds

### Design of butt welds:

For butt welds the most critical form of loading is tension applied in the transverse direction. It has been observed from tests conducted on tensile coupons containing a full penetration butt weld normal to the applied load that the welded joint had higher strength than the parent metal itself. The yield stress of the weld metal and the parent metal in the HAZ region was found to be much higher than the parent metal.

The butt weld is normally designed for direct tension or compression. However, a provision is made to protect it from shear. Design strength value is often taken the same as the parent metal strength. For design purposes, the effective area of the butt-welded connection is taken as the effective length of the weld times the throat size. Effective length of the butt weld is taken as the length of the continuous full size weld. The throat size is specified by the effective throat thickness. For a full penetration butt weld, the throat dimension is usually assumed as the thickness of the thinner part of the connection. Even though a butt weld may be reinforced on both sides to ensure full cross-sectional areas, its effect is neglected while estimating the throat dimensions.

Such reinforcements often have a negative effect, producing stress concentration, especially under cyclic loads.

Unsealed butt welds of V, U, J and bevel types and incomplete penetration butt welds should not be used for highly stressed joints and joints subjected to dynamic and alternating loads. Intermittent butt welds are used to resist shear only and the effective length should not be less than four times the longitudinal space between the effective length of welds nor more than 16 times the thinner part. They are not to be used in locations subjected to dynamic or alternating stresses. Some modern codes do not allow intermittent welds in bridge structures.

For butt welding parts with unequal cross sections, say unequal width, or thickness, the dimensions of the wider or thicker part should be reduced at the butt joint to those of the smaller part. This is applicable in cases where the difference in thickness exceeds 25 % of the thickness of the thinner part or 3.0 mm, whichever is greater. The slope provided at the joint for the thicker part should not be steeper than one in five. In instances, where this is not practicable, the weld metal is built up at the junction equal to a thickness which is at least 25 % greater than the thinner part or equal to the dimension of the thicker part [Fig.3.20 (c)]. Where reduction of the wider part is not possible, the ends of the weld shall be returned to ensure full throat thickness.

Stresses for butt welds are assumed same as for the parent metal with a thickness equal to the throat thickness (Cl.10.5.7.1). For field welds, the permissible stresses in shear and tension calculated using a partial factor  $\gamma_{mw}$  of 1.5. (Cl.10.5.7.2)

### Design of fillet welds:

Fillet welds are broadly classified into side fillets and end fillets (Fig.3.21). When a connection with end fillet is loaded in tension, the weld develops high strength and the stress developed in the weld is equal to the value of the weld metal. But the ductility is

minimal. On the other hand, when a specimen with side weld is loaded, the load axis is parallel to the weld axis. The weld is subjected to shear and the weld shear strength is limited to just about half the weld metal tensile strength. But ductility is

considerably improved. For intermediate weld positions, the value of strength and ductility show intermediate values.

*Stresses Due to Individual forces* - When subjected to either compressive or tensile or shear force alone, the stress in the weld is given by:

$$f_a \text{ or } q = \frac{P}{t_t l_w}$$

Where

$f_a$  = calculated normal stress due to axial force in N/mm<sup>2</sup>

$q$  = shear stress in N/mm<sup>2</sup>

$P$  = force transmitted (axial force  $N$  or the shear force  $Q$ )

$t_t$  = effective throat thickness of weld in mm

$l_w$  = effective length of weld in mm

The design strength of a fillet weld,  $f_{wd}$ , shall be based on its throat area (Cl.10.5.7).

$$f_{wd} = f_{wn} / \gamma_{mw}$$

in which

$$f_{wn} = f_u / 3$$

Where  $f_u$  = smaller of the ultimate stress of the weld and the parent metal and

$\gamma_{mw}$  = partial safety factor (=1.25 for shop welds and = 1.5 for field welds)

The design strength shall be reduced appropriately for long joints as prescribed in the code.

The size of a normal fillet should be taken as the minimum leg size.

#### Minimum size of first run or of a single run fillet weld

Thickness of thicker part (mm)	Minimum size (mm)
$t \leq 10$	3
$10 < t \leq 20$	5
$20 < t \leq 32$	6
$32 < t \leq 50$	8 (First run) 10 (Minimum size of fillet)

For stress calculations, the effective throat thickness should be taken as  $K$  times fillet size, where  $K$  is a constant. Values of  $K$  for different angles between tension fusion faces are given in Table 3.5 (Cl.10.5.3.2). Fillet welds are normally used for connecting parts whose fusion faces form angles between  $60^\circ$  and  $120^\circ$ . The actual length is taken as the length having the effective length plus twice the weld size. Minimum effective length should not be less than four times the weld size. When a fillet weld is provided to square edge of a part, the weld size should be at least 1.5 mm less than the edge thickness. For the rounded toe of a rolled section, the weld size should not exceed  $3/4$  thickness of the section at the toe (Cl.10.5.8.1).

#### Value of $K$ for different angles between fusion faces

Angle between fusion faces	$60^\circ - 90^\circ$	$91^\circ - 100^\circ$	$101^\circ - 106^\circ$	$107^\circ - 113^\circ$	$114^\circ - 120^\circ$
Constant $K$	0.70	0.65	0.60	0.55	0.50



### Design of plug and slot welds:

In certain instances, the lengths available for the normal longitudinal fillet welds may not be sufficient to resist the loads. In such a situation, the required strength may be built up by welding along the back of the channel at the edge of the plate if sufficient space is available. Another way of developing the required strength is by providing slot or plug welds. Slot and plug welds are generally used along with fillet welds in lap joints. On certain occasions, plug welds are used to fill the holes that are temporarily made for erection bolts for beam and column connections. However, their strength may not be considered in the overall strength of the joint.

The limitations given in specifications for the maximum sizes of plug and slot welds are necessary to avoid large shrinkage, which might be caused around these welds when they exceed the specified sizes. The strength of a plug or slot weld is calculated by considering the allowable stress and its nominal area in the shearing plane. This area is usually referred to as the faying surface and is equal to the area of contact at the base of the slot or plug. The length of the slot weld can be obtained from the following relationship:

$$L = \frac{\text{Load}}{(\text{Width}) \text{ allowable stress}}$$

# UNIT – II

## ECCENTRIC AND MOMENT CONNECTIONS

### BEAMS

#### Introduction

One of the frequently used structural members is a beam whose main function is to transfer load principally by means of flexural or bending action. In a structural framework, it forms the main horizontal member spanning between adjacent columns or as a secondary member transmitting floor loading to the main beams. Normally only bending effects are predominant in a beam except in special cases such as crane girders, where effects of torsion in addition to bending have to be specifically considered.

The type of responses of a beam subjected to simple uniaxial bending. The response in a particular case depends upon the proportions of the beam, the form of the applied loading and the type of support provided. In addition to satisfying various strength limits as given in the Table, the beam should also not deflect too much under the working loads i.e. it has to satisfy the serviceability limit state also.

Recently, IS: 800, the structural steel code has been revised and the limit state method of design has been adopted in tune with other international codes of practice such as BS, EURO, and AISC. This chapter attempts to throw light on the provisions for bending members in this code.

### BEAM COLUMNS

The Indian steel code is now in the process of revision as specification-based design gives way to performance-based design. An expert committee mainly comprising eminent academics from IIT Madras, Anna University Chennai, SERC Madras and INSDAG Kolkata was constituted to revise IS: 800 in LSM version. The Limit State Method (referred to as LSM below) is recognized, as one of the most rational methods toward realization of performance-based design, but to date there are no steel-intensive buildings in India that have been designed using LSM. We considered that, because building collapse is caused by excessive deformation, the ultimate state should be evaluated from the deformation criteria. The proposed design procedure evaluates the ultimate limit state on the basis of the deformation capacity of structural members.

The magnification factors, used to confirm suitable flexural mechanisms, severely affect the overall probability of failure, and should be determined so that the overall probability of failure does not exceed specific allowable limits.

In practice, the structural members are generally subjected to various types of combination of stress resultants. Depending upon external actions over the members in structural framing system, the combined forces may be broadly categorized as i) Combined Shear and Bending, ii) Combined Axial Tension and Bending and iii) Combined Axial Compression and Bending.

Normally, the design of an individual member in a frame is done, by separating it from the frame and dealing with it as an isolated substructure. The end conditions of

the member should then comply with its deformation conditions, in the spatial frame, in a conservative way, e.g. by assuming a nominally pinned end condition, and the internal action effects, at the ends of the members, should be considered by applying equivalent external end moments and end forces. Before proceeding for any analysis, classification of these members shall have to be satisfied in accordance with clause no. 3.7 and all related sub-clauses under section 3 of IS: 800 – LSM version.

For all practical purposes, we can equate the third case with the case of Beam-columns. Beam-columns are defined as members subject to combined bending and compression. In principle, all members in moment resistant framed structures (where joints are considered as rigid) are actually beam-columns, with the particular cases of beams ( $F = 0$ ) and columns ( $M = 0$ ) simply being the two extremes. Depending upon the exact way in which the applied loading is transferred into the member, the form of support provided and the member's cross-sectional shape, different forms of response will be possible.

The simplest of these involves bending applied about one principal axis only, with the member responding by bending solely in the plane of the applied moment.

Recently, IS: 800, the Indian Standard Code of Practice for General Construction in Steel is in the process of revision and an entirely new concept of limit state method of design has been adopted in line with other international codes of practice such as BS, EURO, and AISC. Additional Sections and features have been included to make the code a state-of-the-art one and for efficient & effective use of structural steel. Attempt has been made in the revised code to throw some light into the provisions \ for members subjected to forces, which are combined in nature.

## **BEAM – COLUMN CONNECTIONS**

### **Introduction:**

Beam-to-column connections are neither ideally pinned nor ideally fixed and possess a finite non-zero stiffness. However they are classified as simple (pinned), semi-rigid and rigid (fixed) depending on the connection stiffness (Fig.

1.1). Such a classification helps in simplifying the analysis of frames. A connection having a small stiffness can be assumed as pinned while a connection having a large stiffness can be assumed as fixed. In the former case, the actual mid-span bending moments will be less than what is designed for while in the latter case the mid-span deflection will be more than what is calculated. Traditionally, certain configurations are idealized as pinned and certain other configurations are idealized as fixed but with a variety of new configurations being used it is important to have guideline indicating the range of stiffness for which the idealization can be used without serious discrepancy between analysis and actual behaviour. This is done by means of connection classification.

### **Connection classification:**

The Classification proposed by Bjorhovde et al. (1990) is recommended by the IS 800 code and is explained here. Connections are classified according to their ultimate strength or in terms of their initial elastic stiffness. The classification is based on the non-dimensional moment parameter ( $m_1 = M_u / M_{pb}$ ) and the non-dimensional rotation ( $q_1 = q_r / q_p$ ) parameter, where  $q_p$  is the plastic rotation. The Bjorhovde's classification is based on a reference length of the beam equal to 5 times the depth of the beam. The limits used for connection classification are shown in Table.

### Connection classification limits: In terms of strength

Nature of the connection	In terms of strength	In terms of Stiffness
Rigid connection	$m^1 \geq 0.7$	$m^1 \geq 2.5\theta^1$
Semi-Rigid connection	$0.7 > m^1 > 0.2$	$2.5\theta^1 > m^1 > 0.5\theta^1$
Flexible connection	$m^1 \leq 0.2$	$m^1 \leq 0.5\theta^1$

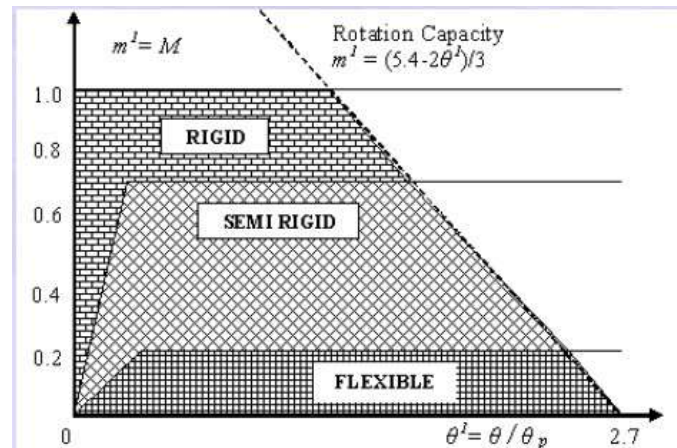

**Classification of Connections according to Bjorhovde (1990)**

The design of fundamental structural elements, viz., compression, tension and flexural members, and also the design of simple connections have been discussed in the previous chapters. In the frame of a steel building, a beam may be attached to another beam or to a column. In such cases, designs of connections under a system of loads on the elements primarily depend on an understanding of the behaviour of the elements and their connections. The decision of the designer depends more upon this understanding rather than on sophisticated theoretical analysis. Therefore, a designer should be conversant with the different ways in which a connection can be made between beams to column and beam to beam, and the way it will behave under a given system of loads.

The beam to column connections expected to resist and transfer end reactions only are termed as *shear connections* or *flexible connections*. These permit free rotation of the beam end and do not have any moment restraint. Other type of connections which do not permit any relative rotation between the beam and column and are expected to resist moments in addition to end reactions are termed as *moment connections* or *rigid connections*. An example of a 100 per cent rigid connection is a welded moment resistant connection. However, these connections do not behave as desired and are relatively flexible or rigid. A third type of connection which resists end moments as well as permits relative rotation between the beam and column is termed as a *semi-rigid connection*. As there are no perfectly rigid connections nor completely flexible ones, all connections really are partly restrained to one degree or another.

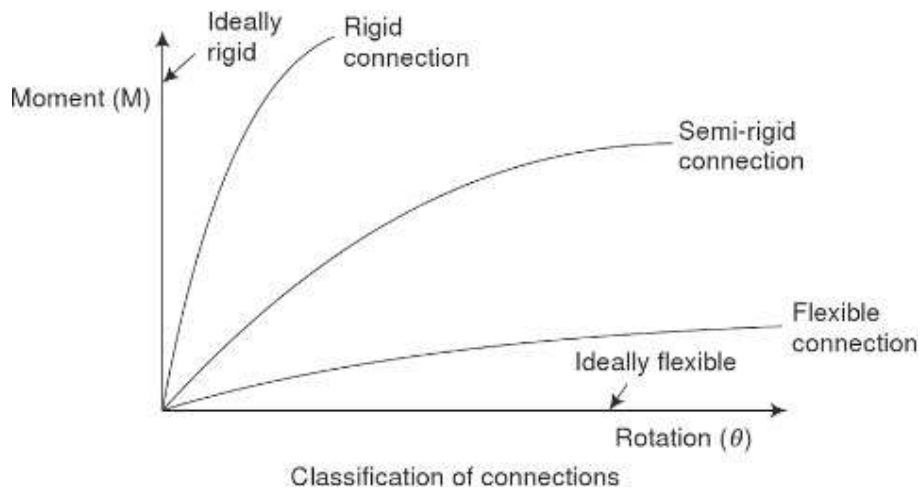

### *Connection Classification Limits*

S. No.	<i>Nature of the Connection</i>	<i>In terms of Strength</i>	<i>In terms of Stiffness</i>
1.	Rigid connection	$m^1 \geq 0.7$	$m^1 \geq 2.5 \theta^1$
2.	Semi-rigid connection	$0.7 > m^1 > 0.2$	$2.5 \theta^1 > m^1 > 0.5 \theta^1$
3.	Flexible connection	$m^1 \leq 0.2$	$m^1 \leq 0.5 \theta^1$

Some of the ways to connect a beam with a column or with another beam are discussed as follows:

Simple connections of beams to columns can be either seated or framed. In a seat connection, the beam is supported over an angle section connected to the column. In this case, one leg of the angle is used to make a seat for the beam and the other leg is connected to the column flange. Another angle, called cleat angle or clip angle, is provided on the top flange of the beam as shown in Fig. 13.6 (a). In case, the space limitation proves a problem above the beam, the top angle may be placed in the optional location on the web of the beam shown by dotted lines in Fig. 13.6(b). This top cleat angle at either of the locations is very helpful in keeping the top flange of the beam from being accidentally twisted out of place during construction. Further, the cleat angle provides lateral stability to the compression flange at the ends by restraining the beam end against torsion. This connection is termed an *unstiffened seat connection*.

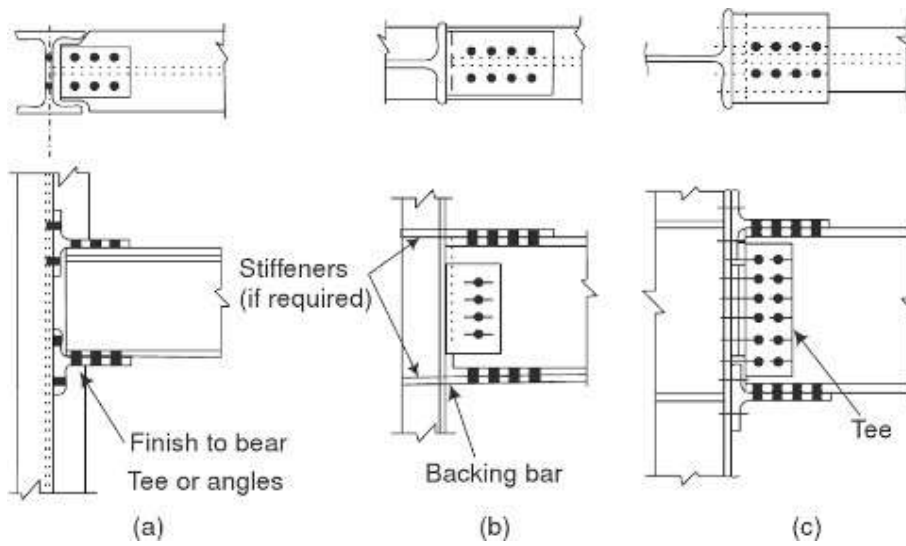

Some Rigid Moment Connections

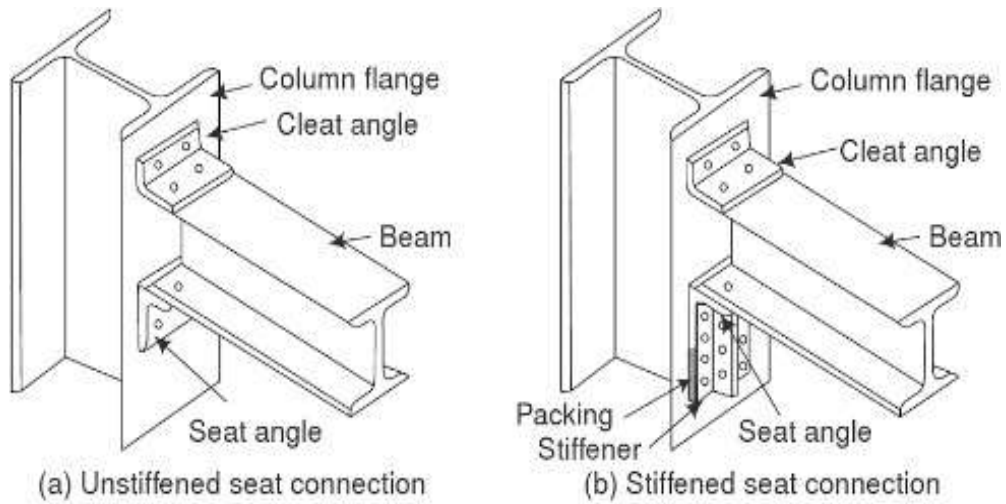

*Bolted seat connections*

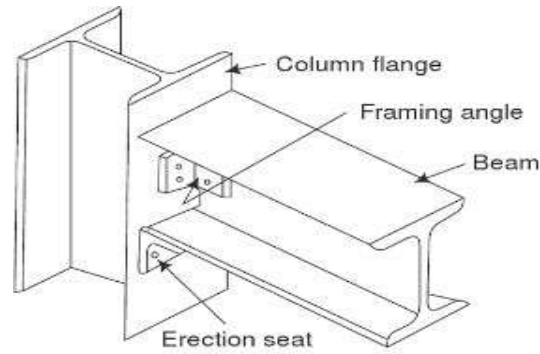

*Bolted framed connection—  
beam to column*

A beam may be supported over a bracket connected to a column. When the bracket is made up of two plates connected to the column flanges as shown in Fig. 13.9 (a), it is called *bracket connection-Type I*. Figure 13.9 (b) and (c) depict *bracket connection-Type II* wherein a bracket plate with a pair of angles one on each side of the bracket plate (Fig. 13.9 (b)) or a bracket-tee is connected perpendicular to the column flange (Fig. 13.9 (c)). The joints in such cases transmit shear and moment due to eccentricity of the shear force. The moment may be either in the plane of the connection, or in a plane perpendicular to the connection. In the bracket connection-Type I, the connectors are subjected to a shear force and additional shear due to torsion, whereas in bracket connection-Type II the connectors are subjected to a direct shear force and tension due to bending. The bracket type connections are usually provided in industrial buildings to support gantry girders.

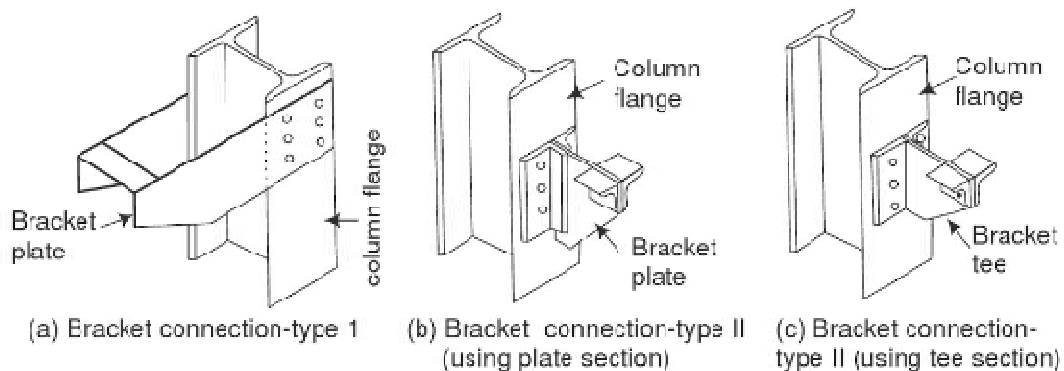

*Bolted bracket connections*

## CONNECTIONS SUBJECTED TO ECCENTRIC SHEAR

The examples of connections subjected to eccentric shear are seat connections, framed connections, and bracket connection; the latter being usually provided to support gantry girders in industrial buildings. Simple connections of beam to column can be either seated or framed as shown in . The seat connections and the framed connections are so constructed that they transmit the beam reaction close to the face of the column without developing significant moments. In order to make these connections to have as little moment resistance as possible, the angle used in making up the connections should be as light and flexible as possible. For these connections to provide simple end support conditions the ends of the beams should be as free as possible to rotate downwards (Fig. 13.10). To achieve this an adequate gap (10–15 mm) between the connected members is provided. The bracket connections on the other hand support reactions from girders at significant eccentricity and therefore develop accountable moments also.

This type of connection is most frequently used to connect floor beams to other beams, girders or columns. For most of the steel buildings which are low-rise, framed connections are very common. The framing angles are usually set back from the connected beam web by about 10 mm which help in fitting members during erection process. The framing angles are used in pairs, i.e. one on each side of the web of the beam (Figs. 13.7 and 13.8). One leg of the angle is connected to the web in the shop and is called the *connected leg*. The other leg of the angle is connected to the flange of the column or girder in the field and is called the *outstanding leg*. Standard sizes of framing angles are used, viz. 100 × 75 mm, 150 × 100 mm, 150 × 150 mm. Generally an 8 mm, 10 mm or 12 mm thick angle is used. The thickness is so selected that the strength of the bolt is not governed by the bearing on framing angle legs. The thickness of the framing angles must also be limited to ensure necessary flexibility.



## UNIT – III

### ANALYSIS AND DESIGN OF INDUSTRIAL BUILDINGS

Dead loads, live loads and wind loads on roofs. Design wind speed and pressure, wind pressure on roofs; wind effect on cladding and louvers; design of angular roof truss, tubular truss, truss for a railway platform.

Design of purlins for roofs, design of built up purlins, design of knee braced trusses and stanchions. Design of bracings.

#### Loads

##### Dead load

Dead load on the roof trusses in single storey industrial buildings consists of dead load of claddings and dead load of purlins, self weight of the trusses in addition to the weight of bracings etc. Further, additional special dead loads such as truss supported hoist dead loads; special ducting and ventilator weight etc. could contribute to roof truss dead loads. As the clear span length (column free span length) increases, the self weight of the moment resisting gable frames (Fig. 2.2b) increases drastically. In such cases roof trusses are more economical. Dead loads of floor slabs can be considerably reduced by adopting composite slabs with profiled steel sheets as described later in this chapter.

##### Live load

The live load on roof trusses consist of the gravitational load due to erection and servicing as well as dust load etc. and the intensity is taken as per IS:875-1975. Additional special live loads such as snow loads in very cold climates, crane live loads in trusses supporting monorails may have to be considered.

##### Wind load

Wind load on the roof trusses, unless the roof slope is too high, would be usually uplift force perpendicular to the roof, due to suction effect of the wind blowing over the roof. Hence the wind load on roof truss usually acts opposite to the gravity load, and its magnitude can be larger than gravity loads, causing reversal of forces in truss members.

##### Earthquake load

Since earthquake load on a building depends on the mass of the building, earthquake loads usually do not govern the design of light industrial steel buildings. Wind loads usually govern. However, in the case of industrial buildings with a large mass located at the roof or upper floors, the earthquake load may govern the design. These loads are calculated as per IS: 1893-2002

#### Roof systems

Trusses are triangular frame works, consisting of essentially axially loaded members which are more efficient in resisting external loads since the cross section is nearly uniformly stressed. They are extensively used, especially to span large gaps. Trusses are used in roofs of single storey industrial buildings, long span floors and roofs of multistory buildings, to resist gravity loads. Trusses are also used in walls and horizontal planes of industrial buildings to resist lateral loads and give lateral stability.

## Analysis of trusses

Generally truss members are assumed to be joined together so as to transfer only the axial forces and not moments and shears from one member to the adjacent members (they are regarded as being pinned joints). The loads are assumed to be acting only at the nodes of the trusses. The trusses may be provided over a single span, simply supported over the two end supports, in which case they are usually statically determinate. Such trusses can be analysed manually by the method of joints or by the method of sections.

Computer programs are also available for the analysis of trusses.

From the analysis based on pinned joint assumption, one obtains only the axial forces in the different members of the trusses. However, in actual design, the members of the trusses are joined together by more than one bolt or by welding, either directly or through larger size end gussets. Further, some of the members, particularly chord members, may be continuous over many nodes.

Generally such joints enforce not only compatibility of translation but also compatibility of rotation of members meeting at the joint. As a result, the members of the trusses experience bending moment in addition to axial force.

This may not be negligible, particularly at the eaves points of pitched roof trusses, where the depth is small and in trusses with members having a smaller slenderness ratio (i.e. stocky members). Further, the loads may be applied in between the nodes of the trusses, causing bending of the members. Such stresses are referred to as secondary stresses. The secondary bending stresses can be caused also by the eccentric connection of members at the joints. The analysis of trusses for the secondary moments and hence the secondary stresses can be carried out by an indeterminate structural analysis, usually using computer software.

The magnitude of the secondary stresses due to joint rigidity depends upon the stiffness of the joint and the stiffness of the members meeting at the joint. Normally the secondary stresses in roof trusses may be disregarded, if the slenderness ratio of the chord members is greater than 50 and that of the web members is greater than 100. The secondary stresses cannot be neglected when they are induced due to application of loads on members in between nodes and when the members are joined eccentrically. Further the secondary stresses due to the rigidity of the joints cannot be disregarded in the case of bridge trusses due to the higher stiffness of the members and the effect of secondary stresses on fatigue strength of members. In bridge trusses, often misfit is designed into the fabrication of the joints to create prestress during fabrication opposite in nature to the secondary stresses and thus help improve the fatigue performance of the truss members at their joints.

## Configuration of trusses

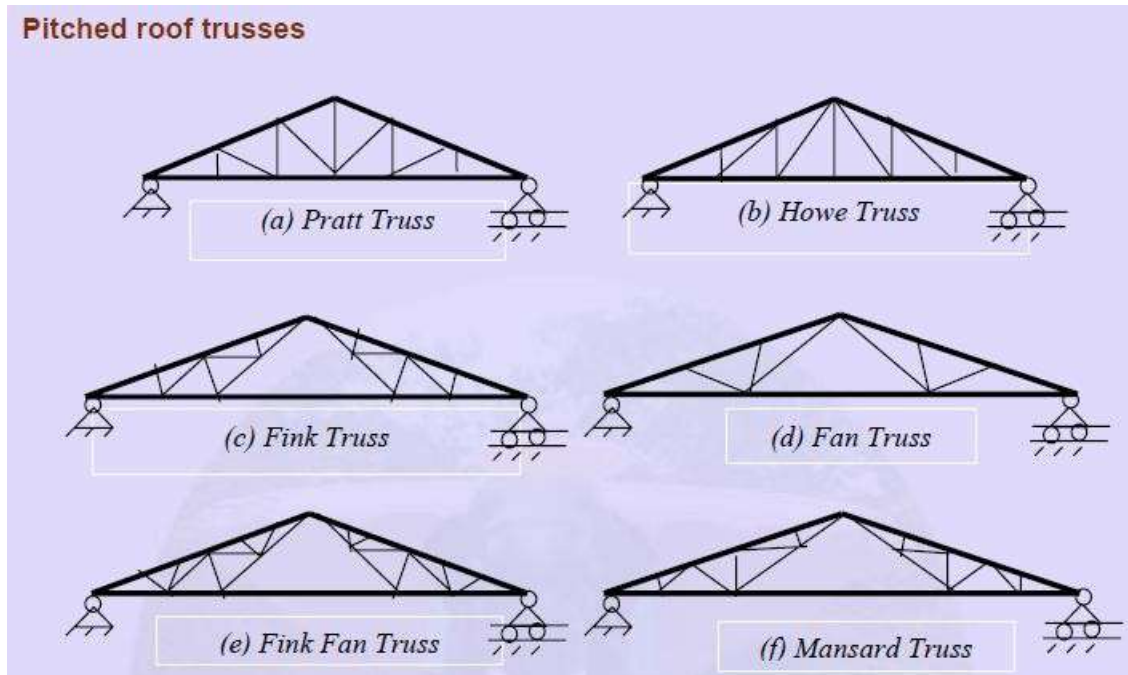

Most common types of roof trusses are pitched roof trusses wherein the top chord is provided with a slope in order to facilitate natural drainage of rainwater and clearance of dust/snow accumulation. These trusses have a greater depth at the mid-span. Due to this even though the overall bending effect is larger at mid-span, the chord member and web member stresses are smaller closer to the mid-span and larger closer to the supports. The typical span to maximum depth ratios of pitched roof trusses are in the range of 4 to 8, the larger ratio being economical in longer spans. Pitched roof trusses may have different configurations. In Pratt trusses [Fig. 2.9(a)] web members are arranged in such a way that under gravity load the longer diagonal members are under tension and the shorter vertical members experience compression. This allows for efficient design, since the short members are under compression. However, the wind uplift may cause reversal of stresses in these members and nullify this benefit.

The converse of the Pratt is the Howe truss [Fig. 2.9(b)]. This is commonly used in light roofing so that the longer diagonals experience tension under reversal of stresses due to wind load.

Fink trusses [Fig. 2.9(c)] are used for longer spans having high pitch roof, since the web members in such truss are sub-divided to obtain shorter members.

Fan trusses [Fig. 2.9(d)] are used when the rafter members of the roof trusses have to be sub-divided into odd number of panels. A combination of fink and fan [Fig. 2.9(e)] can also be used to some advantage in some specific situations requiring appropriate number of panels.

Mansard trusses [Fig. 2.9(f)] are variation of fink trusses, which have shorter leading diagonals even in very long span trusses, unlike the fink and fan type trusses.

The economical span lengths of the pitched roof trusses, excluding the

Mansard trusses, range from 6 m to 12 m. The Mansard trusses can be used in the span ranges of 12 m to 30 m.

### Parallel chord trusses

The parallel chord trusses are used to support North Light roof trusses in buildings as well as in intermediate span bridges. Parallel chord trusses are also used as pre-fabricated floor joists, beams and girders in multi-storey buildings [Fig. 2.10(a)]. Warren configuration is frequently used [Figs. 2.10(b)] in the case of parallel chord trusses. The advantage of parallel chord trusses is that they use webs of the same lengths and thus reduce fabrication costs for very long spans. Modified Warren is used with additional verticals, introduced in order to reduce the unsupported length of compression chord members. The saw tooth north light roofing systems use parallel chord lattice girders [Fig. 2.10(c)] to support the north light trusses and transfer the load to the end columns.

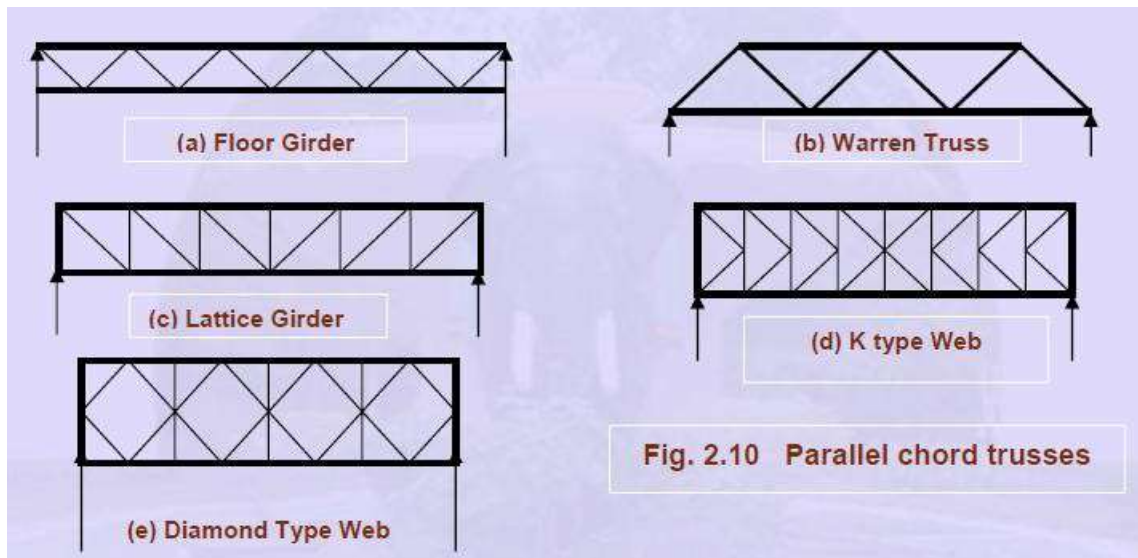

The economical span to depth ratio of the parallel chord trusses is in the range of 12 to 24. The total span is subdivided into a number of panels such that the individual panel lengths are appropriate (6m to 9 m) for the stringer beams, transferring the carriage way load to the nodes of the trusses and the inclination of the web members are around 45 degrees. In the case of very deep and very shallow trusses it may become necessary to use K and diamond patterns for web members to achieve appropriate inclination of the web members. [Figs. 2.10(d), 2.10(e)]

### Trapezoidal trusses

In case of very long span length pitched roof, trusses having trapezoidal configuration, with depth at the ends are used [Fig. 2.11(a)]. This configuration reduces the axial forces in the chord members adjacent to the supports. The secondary bending effects in these members are also reduced. The trapezoidal configurations [Fig. 2.11(b)] having the sloping bottom chord can be economical in very long span trusses (spans > 30 m), since they tend to reduce the web member length and the chord members tend to have nearly constant forces over the span length. It has been found that bottom chord slope equal to nearly half as much as the rafter slope tends to give close to optimum design.



### Truss members

The members of trusses are made of either rolled steel sections or built-up sections depending upon the span length, intensity of loading, etc. Rolled steel angles, tee sections, hollow circular and rectangular structural tubes are used in the case of roof trusses in industrial buildings [Fig. 2.12(a)]. In long span roof trusses and short span bridges heavier rolled steel sections, such as channels, I sections are used [Fig. 2.12(b)]. Members built-up using I sections, channels, angles and plates are used in the case of long span bridge trusses [Fig. 2.12(c)]

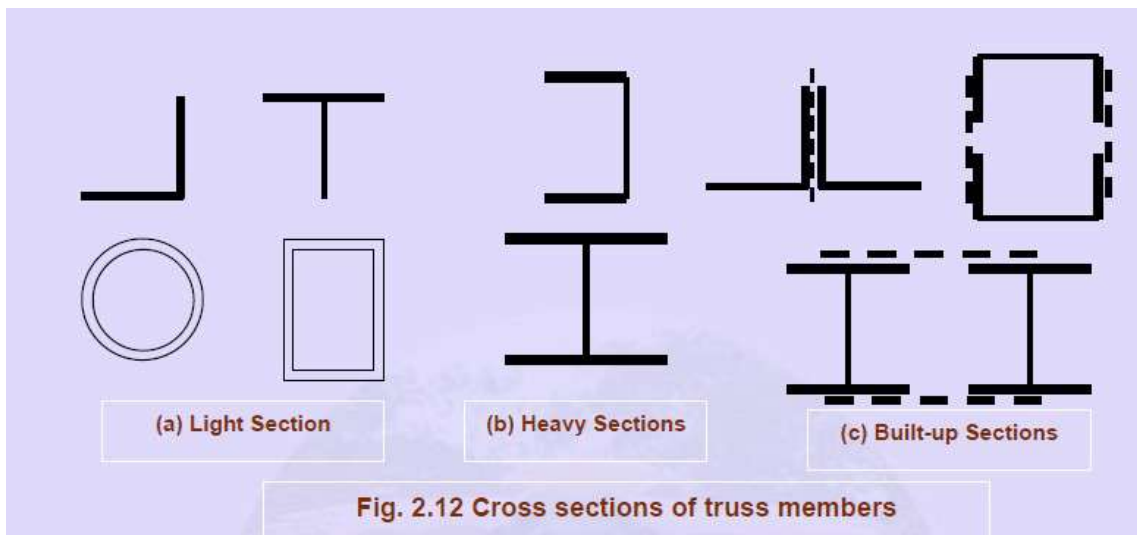

Accesses to surface, for inspection, cleaning and repainting during service, are important considerations in the choice of the built-up member configuration. Surfaces exposed to the environments, but not accessible for maintenance are vulnerable to severe corrosion during life, thus reducing the durability of the structure. In highly corrosive environments fully closed welded box sections, and circular hollow sections are used to reduce the maintenance cost and improve the durability of the structure.

### Truss connections

Members of trusses can be joined by riveting, bolting or welding. Due to involved procedure and highly skilled labour requirement, riveting is not common these days. High strength friction grip (HSFG) bolting and welding have become more common. Shorter span trusses are usually fabricated in shops and can be completely welded and transported to site as one unit. Longer span trusses can be prefabricated in

segments by welding in shop. These segments can be assembled by bolting or welding at site. This results in a much better quality of the fabricated structure.

Truss connections form a high proportion of the total truss cost. Therefore it may not always be economical to select member sections, which are efficient but cannot be connected economically. Trusses may be single plane trusses in which the members are connected on the same side of the gusset plates or double plane trusses in which the members are connected on both sides of the gusset plates.

It may not always be possible to design connection in which the centroidal axes of the member sections are coincident [Fig. 2.13(a)]. Small eccentricities may be unavoidable and the gusset plates should be strong enough to resist or transmit forces arising in such cases without buckling (Fig. 2.13b). The bolts should also be designed to resist moments arising due to in-plane eccentricities.

If out-of-plane instability is foreseen, use splice plates for continuity of out-of plane stiffness.

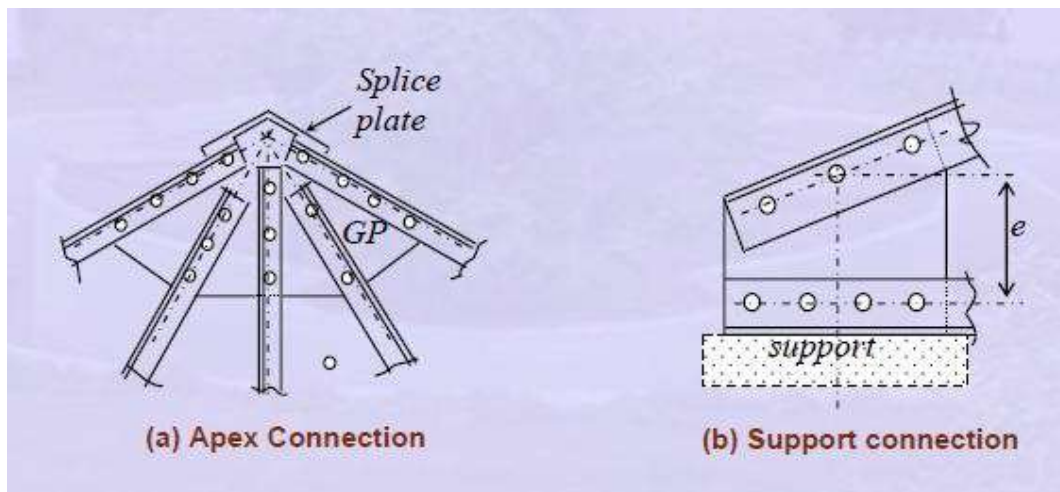

**Truss connections**

If the rafter and tie members are T sections, angle diagonals can be directly connected to the web of T by welding or bolting. Frequently, the connections between the members of the truss cannot be made directly, due to inadequate space to accommodate the joint length. In such cases, gusset plates are used to accomplish such connections. The size, shape and the thickness of the gusset plate depend upon the size of the member being joined, number and size of bolt or length of weld required, and the force to be transmitted. The thickness of the gusset is in the range of 8 mm to 12 mm in the case of roof trusses and it can be as high as 22 mm in the case of bridge trusses. The design of gussets is usually by rule of thumb. In short span (8 – 12 m) roof trusses, the member forces are smaller, hence the thickness of gussets are lesser (6 or 8 mm) and for longer span lengths (> 30 m) the thickness of gussets are larger (12 mm). The designs of gusset connections are discussed in a chapter on connections.

### **Design of trusses**

Factors that affect the design of members and the connections in trusses are discussed in this section.

### **Instability considerations**

While trusses are stiff in their plane they are very weak out of plane. In order to stabilize the trusses against out-of-plane buckling and to carry any accidental out of plane load, as well as lateral loads such as wind/earthquake loads, the trusses are to be properly braced out-of-plane. The instability of compression members, such as compression chord, which have a long unsupported length out-of-plane of the truss, may also require lateral bracing.

Compression members of the trusses have to be checked for their buckling strength about the critical axis of the member. This buckling may be in plane or out-of-plane of the truss or about an oblique axis as in the case of single angle sections. All the members of a roof truss usually do not reach their limit states of collapse simultaneously. Further, the connections between the members usually have certain rigidity. Depending on the restraint to the members under compression by the adjacent members and the rigidity of the joint, the effective length of the member for calculating the buckling strength may be less than the centre-to-centre length of the joints. The design codes suggest an effective length factor between 0.7 and 1.0 for the in-plane buckling of the member depending upon this restraint and 1.0 for the out of plane buckling.

In the case of roof trusses, a member normally under tension due to gravity loads (dead and live loads) may experience stress reversal into compression due to dead load and wind load combination. Similarly the web members of the bridge truss may undergo stress reversal during the passage of the moving loads on the deck. Such stress reversals and the instability due to the stress reversal should be considered in design. The design standard (IS: 800) imposes restrictions on the maximum slenderness ratio, ( $l/r$ ).

### **Economy of trusses**

As already discussed trusses consume a lot less material compared to beams to span the same length and transfer moderate to heavy loads. However, the labour requirement for fabrication and erection of trusses is higher and hence the relative economy is dictated by different factors. In India these considerations are likely to favour the trusses even more because of the lower labour cost. In order to fully utilize the economy of the trusses the designers should ascertain the following:

- Method of fabrication and erection to be followed, facility for shop fabrication available, transportation restrictions, field assembly facilities. Preferred practices and past experience.
- Availability of materials and sections to be used in fabrication.
- Erection technique to be followed and erection stresses.
- Method of connection preferred by the contractor and client (bolting, welding or riveting).
- Choice of as rolled or fabricated sections.
- Simple design with maximum repetition and minimum inventory of material.

### **Design for wind action**

The wind pressure on a structure depends on the location of the structure, height of structure above the ground level and also on the shape of the structure.

The code gives the basic wind pressure for the structures in various parts of the country. Both the wind pressures viz. including wind of short duration and excluding

wind of short duration have been given. All structures should be designed for the short duration wind.

For buildings upto 10m in height, the intensity of wind pressure, as specified in the code, may be reduced by 25% for stability calculations and for the design of framework as well as cladding. For buildings over 10m and upto 30m height, this reduction can be made for stability calculations and for design only.

The total pressure on the walls or roof of an industrial building will depend on the external wind pressure and also on internal wind pressure. The internal wind pressure depends on the permeability of the buildings. For buildings having a small degree of permeability, the internal air pressure may be neglected. In the case of buildings with normal permeability the internal pressure can be  $\pm 0.2p$ .

Here „+“ indicates pressure and „-“, suction, „p“ is the basic wind pressure. If a building has openings larger than 20% of the wall area, the internal air pressure will be  $\pm 0.5 p$ .

### (a) Wind pressure on walls

The wind pressure per unit area „p“ on the wall is taken as 0.5p pressure on windward surface and 0.5p suction on leeward surface. When the walls form an enclosure, the windward wall will be subjected to a pressure of 0.5p and leeward wall to a suction of 0.5p. The total pressure on the walls will depend on the internal air pressure also.

For buildings with small permeability, design pressure on wall = 0.5p

For buildings with normal permeability, design pressure on wall = 0.7p

For buildings with large openings, design pressure on wall = p

### (b) Wind loads on roofs

Wind pressure on roofs (Wind normal to eaves) Sums of external and internal pressure

Roof of pitch	Zero Permeability		Normal Permeability				Large openings			
	External Pressure		$p_i^* = +0.2p$		$p_i^* = -0.2p$		$p_i^* = +0.5p$		$p_i^* = -0.5p$	
	Windward	Leeward	Windward	Leeward	Windward	Leeward	Windward	Leeward	Windward	Leeward
1	2	3	4	5	6	7	8	9	10	11
0	-1.00	-0.50	-1.2	-0.70	-0.8	-0.30	-1.5	-1.00	-0.5	0.00
10	-0.70	-0.50	-0.9	-0.70	-0.5	-0.30	-1.2	-1.00	-0.2	0.00
20	-0.40	-0.50	-0.6	-0.70	-0.2	-0.30	-0.9	-1.00	+0.1	0.00
30	-0.10	-0.50	-0.3	-0.70	+0.1	-0.30	-0.6	-1.00	+0.4	0.00
40	+0.10	-0.50	-0.1	-0.70	+0.3	-0.30	-0.4	-1.00	+0.6	0.00
50	+0.30	-0.50	+0.1	-0.70	+0.5	-0.30	-0.2	-1.00	+0.8	0.00
60	+0.40	-0.50	+0.2	-0.70	+0.6	-0.30	-0.1	-1.00	+0.9	0.00
70	+0.50	-0.50	+0.3	-0.70	+0.7	-0.30	0	-1.00	+1.00	0.00
80	+0.50	-0.50	+0.3	-0.70	+0.7	-0.30	0	-1.00	+1.00	0.00
90	+0.50	-0.50	+0.3	-0.70	+0.7	-0.30	0	-1.00	+1.00	0.00

$p_i^* \Rightarrow$  internal pressure

The pressure normal to the slope of the roof is obtained by multiplying the basic pressure p by the factors given in Table 13-3. The table also shows the effect of internal pressure produced due to the permeability of the cladding or opening in walls and roof.

If the wind blows parallel to the ridge of the roof, the average external wind pressure of the roof may be taken as -0.6p on both slopes of the roof over a length from the



gable end equal to the mean height of the roof above the surrounding ground level and as  $0.4p$  over the remaining length of the roof on both slopes.

When the wind blows parallel to a surface, a wind force acts on the surface in the direction of the wind. This force is called the „Wind Drag“. In the case of industrial buildings, when the wind blows normal to the ridges, the wind drag is equal to  $0.05p$  measured on plan area of roof and when the direction of wind parallel to the ridge, wind drag is equal to  $0.025p$  measured on plan area of roof.

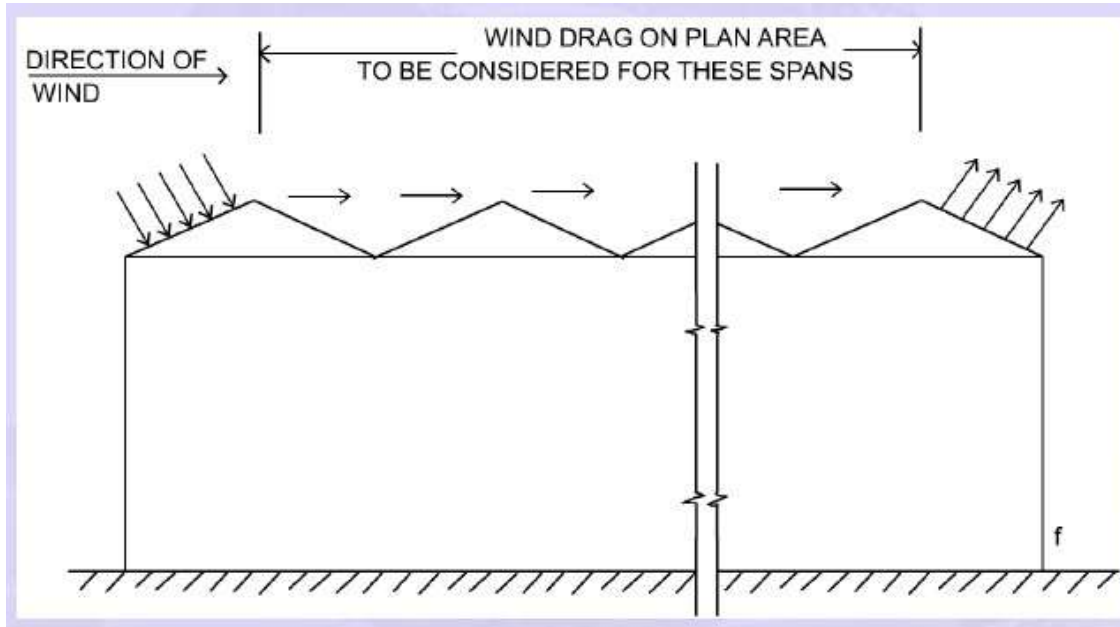

**Wind drag**

In the multispan roofs with spans, heights and slopes nearly equal, the windward truss gives shelter to the other trusses. For general stability calculations and for the design columns, the windward slope of wind-ward span and leeward slope of leeward span are subjected to the full normal pressure of suction as given in table 2.2 and on all other roof slopes, only wind drag is considered (see Fig. 2.29). For the design of roof trusses, however, full normal pressure or suction is considered on both faces, presuming that there was only one span.

The wind pressures given above are the average pressures on a roof slope.

For designing the roof sheeting or the fastenings of roof sheeting, we may take a larger wind pressure because these pressures may considerably exceed the average value on small areas. For designing roof sheeting and its fastenings, the values given in Table 2.2 may be increased numerically by  $0.3p$ . In a distance equal to 15% of the length of the roof from the gable ends, fastenings should be capable of resisting a section of  $2.0p$  on the area of the roof sheeting them support.

# UNIT- IV

## DESIGN OF STEEL TRUSS GIRDER BRIDGES

### INTRODUCTION

Typical configurations of truss beam bridges are shown in Figure 1. Underslung trusses are rarely used in modern construction.

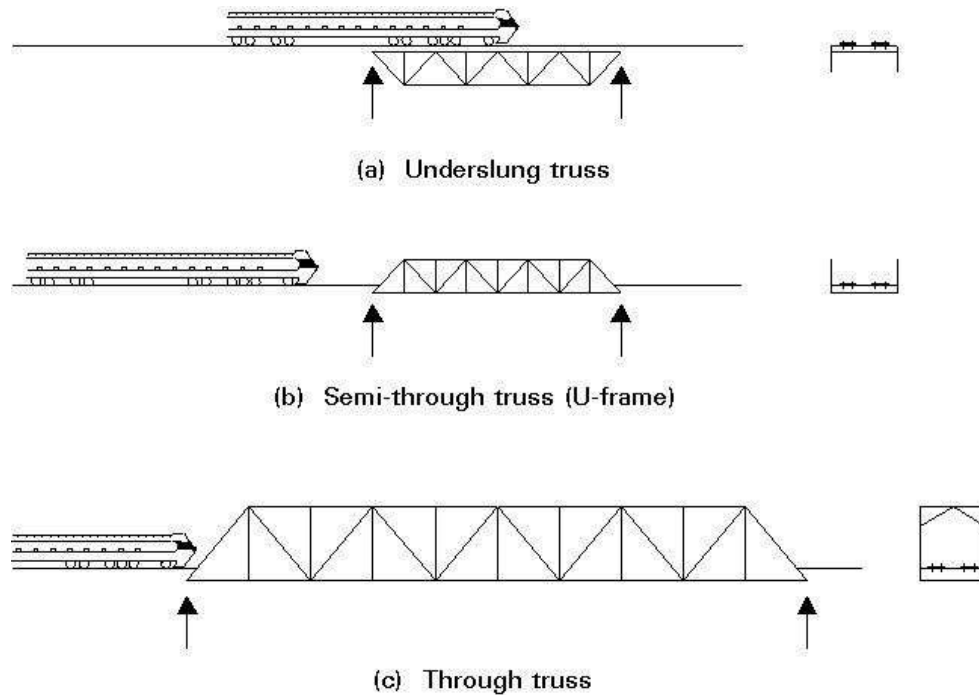

Figure 1 Truss configurations

Through and semi-through truss bridges are used when the depth of deck construction is very limited, for instance, when a highway or a railway crosses a canal.

It is unusual for through-trusses to be economic for highway bridges, except for very long spans. With less severe restrictions on the gradients on the approach embankments it is, in addition, much easier for a road to gain the height required for a deck bridge than for a railway to do so.

Semi-through trusses tend therefore to be used for highways while through and semi-through trusses are still used for railways.

The principle of a truss is simple. The structure is composed of top and bottom chords triangulated with diagonals and/or verticals in the webs so that each member carries purely axial load. Additional effects do exist but in a well designed truss they will be of a secondary nature and may be neglected.

Global moment on a truss is carried as compression and tension in the chords as shown in Figure 2a. Global shear is carried as tension or compression in the diagonal and vertical members. In the simplified case, where the joints are considered as pinned, and the loads are applied at the nodes, the loading creates no bending moment, shear, or torsion in any member. Loads applied in such a way as to cause bending, shear, or torsion usually result in inefficient use of material.

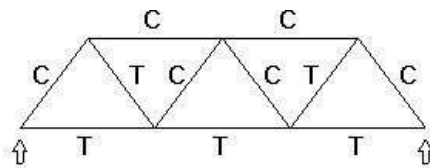

(a) Modern Warren truss:  
spans 30-150m  
T = Tension  
C = Compression

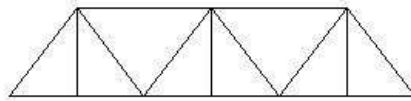

(b)

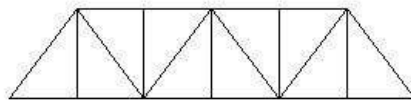

(c)

(b) and (c)  
Modified Warren trusses:  
spans 30-150m:  
still used for railway  
bridges

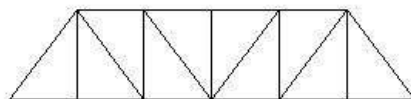

(d) Pratt truss:  
spans 30-100m

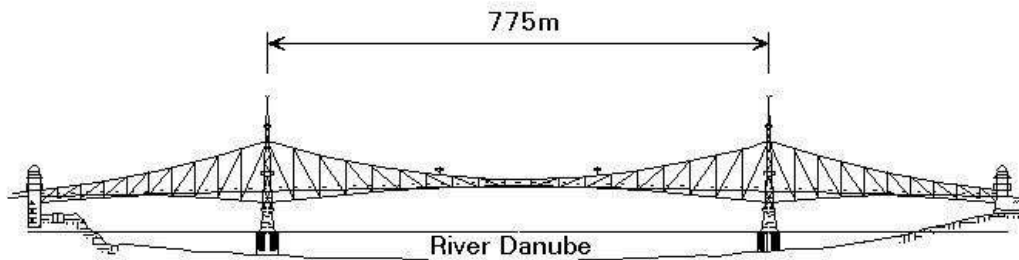

(e) Nagy truss in Budapest (1892)



(f) Lattice truss:  
of historical  
interest only

Figure 2 Principal types of truss

The saving of material compared to a plate girder is clear when the webs are considered. In a truss the webs are mainly 'fresh air' - hence less weight and less wind pressure.

A truss can be assembled from small easily handled and transported pieces, and the site connections can all be bolted. Trusses can have a particular advantage in countries where access to the site is difficult or supply of skilled labour is limited. Undamaged parts of a truss bridge can easily be re-used after an accident or the effects of war.

## **2. DIFFERENT TYPES OF TRUSS**

### **Historical Background**

The truss as a structural form dates back to Roman times. A bronze truss was used in the Pantheon.

In the nineteenth century, the United States can claim to have created the greatest number of different types of truss. Their use of timber and their enthusiastic pioneering spirit created some unlikely looking structures, but nevertheless firmly established the truss as the ideal form of bridge at that time for medium spans.

Eiffel built lattice trusses in France (Figure 2f). Fowler and Baker, however, introduced a major innovation by adopting steel tubular sections as the main compression members for the Forth Bridge which is well known throughout the world for its grandeur. Modern truss bridges also use box sections for the compression members.

The Hungarian architect Virgil Nagy built the very aesthetic Ferenc Jozsef truss girder bridge in Budapest over the Danube in 1892. The bridge is supported by Pratt-truss girders of variable height (Figure 2e). The central span is 175m long with an isostatic central part of 47m.

For most modern bridgework the Warren truss (with its modifications) is perhaps the most commonly used type because of its simplicity. Modern labour costs dictate a minimum of members and connections.

### **Highway Truss Bridges**

The Warren configuration shown in Figure 2 is usually chosen. When the length of the gap to be crossed makes the use of a multiple span bridge unavoidable, it is cheaper and usually possible to raise the road line and build another type of bridge requiring a greater depth under the deck.

For this reason highway truss bridges usually have only one span (Figure 3). Their appearance is well adapted aesthetically to cross canals in flat landscapes.

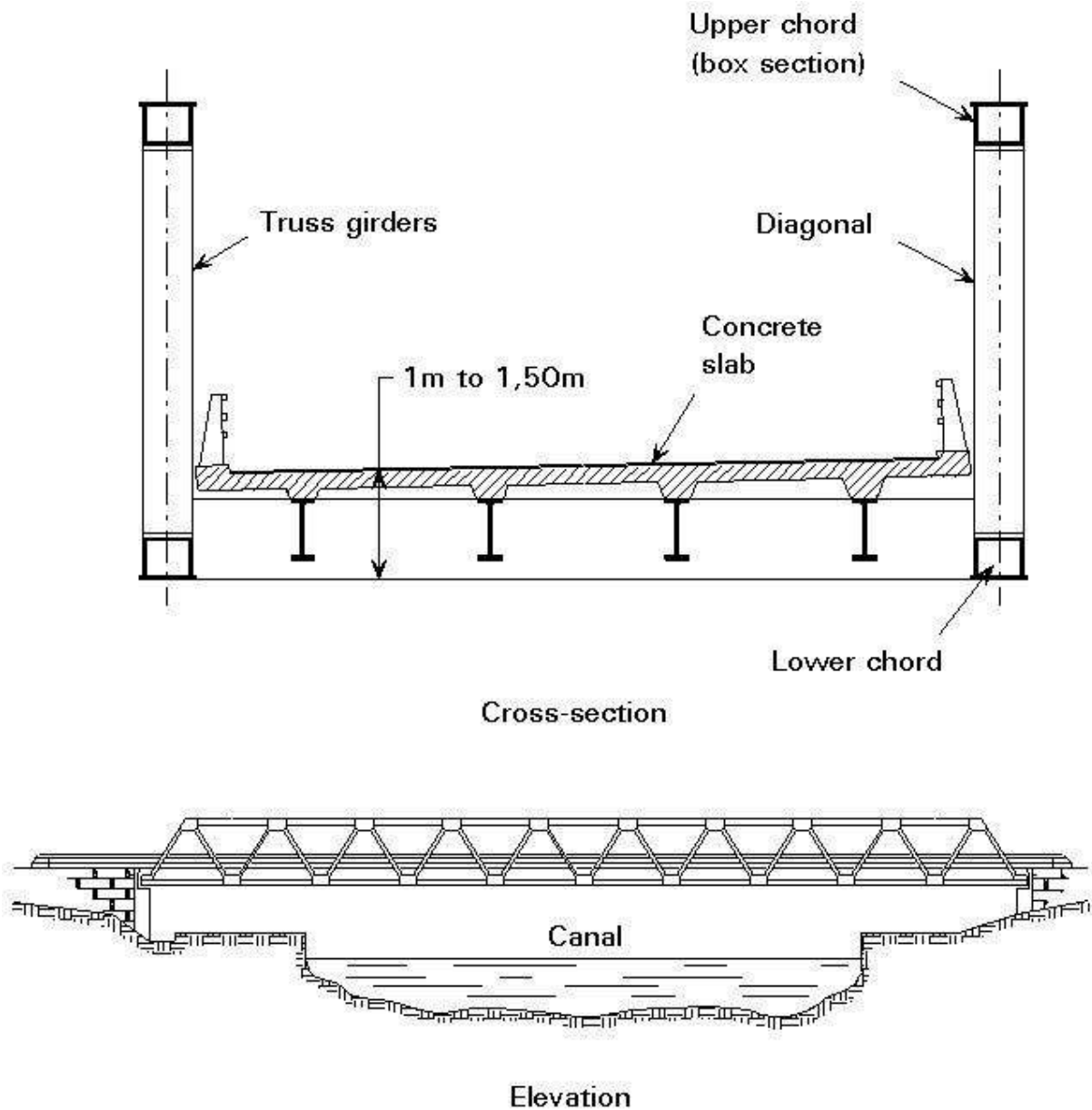

Figure 3 A typical highway truss bridge.

The spans are usually between 60 and 120m which is the normal economic range. The longest span was the old Neuwied bridge over the Rhine (212m) which was replaced by a cable stayed bridge.

The span-to-depth ratio is normally about 15.

## Choice of Truss Configuration For Railway Bridges

Three basic truss bridge configurations are shown in Figure 1.

The most economic truss bridge configuration, especially for railway bridges, is the underslung truss where the live load runs at the level of the top chord. The top chord then serves the dual function of support for the live load (as the sleepers sit directly on the chord) and the main compression member. There is, however, the disadvantage that clearance under the bridge is reduced. It is thus common for the approach spans over a flood plain, or over unnavigable parts of the river, to be underslung while the navigation channels are crossed with through trusses.

Where the spans are short, and underslung trusses are not possible, it may be economic to have the top chord below the loading gauge level by using semi-through trusses. Bracing between the top chords is not possible and restraint to the compression members has to be provided by U-frames. However for spans where semi-through trusses have been used in the past, plate girder bridges are now very competitive, and now semi-through trusses are seldom used for railway bridges.

Where the spans of railway bridges are long the economic depth is usually great enough to allow bracing to be provided above the loading gauge level. Such trusses are termed 'through trusses'. The use of material in bracing rather than U-frames is considerably more efficient.

For shorter spans the choice is between the Warren and the Pratt configuration. In the simple Warren truss, the diagonals work alternatively in compression and tension, whereas in the Pratt truss, all the diagonals are in tension and the shorter posts take compression.

To cater for the heavy loading on railway bridges, the cross girders should be fairly close together. This requirement leads to the hangers of the Modified Warren truss which sub-divide the bottom chord. Economic design of the top compression chord leads to sub-division with a post.

The majority of truss bridges are simple spans, but there are many examples of continuous trusses. The immediate benefit on member forces when a continuous structure is employed is offset to some extent by increased fatigue effects. In a simple truss it is common for only some of the diagonals to be influenced by fatigue. These diagonals are usually those at mid-span where the smallest available section has to be used in any case. In contrast, most of the diagonals in a continuous truss, and some of the chord members may well have to be checked for fatigue, particularly when welded construction is used.

Even where continuous trusses show savings in the use of steel, they may not be economic. On a 1700m long bridge in India, the alternative continuous truss design

was about 5% lighter than the simple spans which were considered more economic on account of standardization of fabrication detail and erection procedure.

It should be noted here that the design loading has a considerable effect on the truss configuration. For example, with combined highway and rail loading, trusses with two decks can be very economic.

### Particular Applications

- As dead load is a dominating factor for movable bridges, bascule spans are often built using steel truss girders. Figure 4a shows an example of a rear part made for a movable truss bridge. Most connections are butt-welded and governed by fatigue considerations. This kind of bridge will not be further discussed here. For more information, see [Lecture 1B.6.2](#).
- Temporary bridges for emergency purposes are almost always truss bridges because of their adaptability to various spans and support conditions, e.g. Eiffel, Bailey, Arromanches, Callender-Hamilton, see Figure 4b.

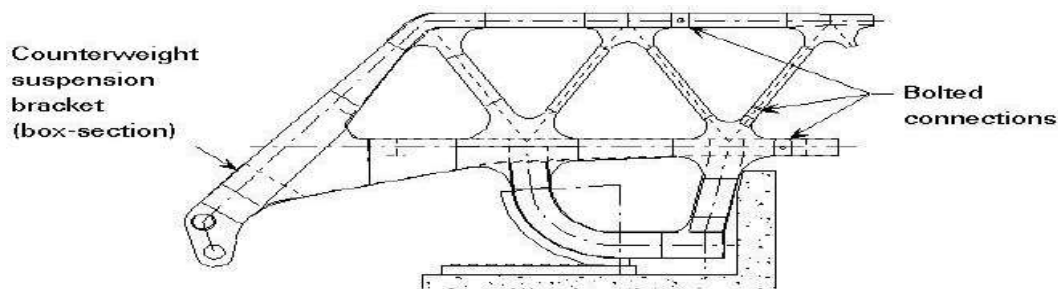

(a) Example of movable truss bridge.  
Rear part of the bridge.

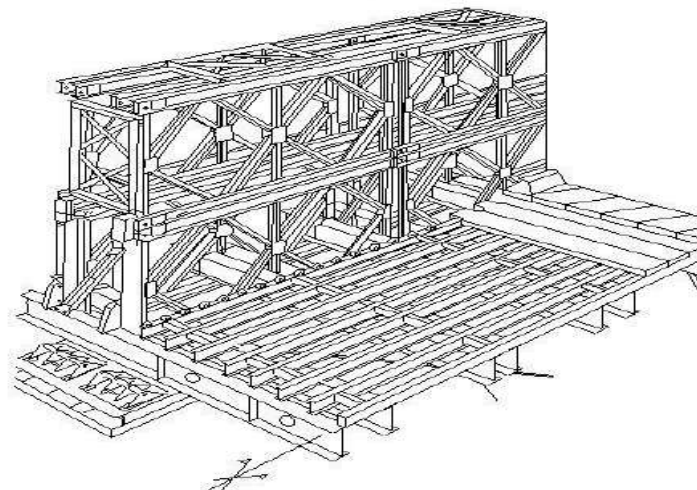

(b) Bailey temporary bridge  
for emergency uses.

Figure 4 Particular applications of trusses  
in bridge construction

### **3. GENERAL DESIGN PRINCIPLES**

#### **Span Range**

For spans from 60m to 120m for highways and from 30m to 150m for railways, simple spans can prove economic when favourable conditions exist.

Large spans using cantilever trusses have reached a main span of 550m. Trusses have to compete against plate girders for shorter spans, against box girders for medium spans and cable-stayed bridges for longer spans.

#### **Ratio of Span to Depth**

The optimum value for this ratio depends on the magnitude of the live load that has to be carried. It should be in the region of 10, being greater for road traffic than for rail traffic. For twin track rail loading the ratio may fall to about 7,5. A check should always be made on the economic depth for a given bridge.

#### **Geometry**

For short and medium spans, it will generally be found economic to use parallel chords to keep fabrication and erection costs down. However, for long continuous spans, a greater depth is often required at the piers, Figure 2e.

Skew truss bridges should be avoided as far as possible.

An even number of bays should be chosen to suit the configuration of diagonals in Pratt and modified Warren trusses. If an odd number is chosen there will be a central bay with crossed diagonals. This arrangement is not usually desirable except perhaps at the centre of a swing bridge. The diagonals should be at an angle between  $50^\circ$  and  $60^\circ$  to the horizontal.

Secondary stresses should be avoided as far as possible by ensuring that the neutral axes of all intersecting members meet at a single point, in both vertical and horizontal planes. This will not always be possible, e.g. cross girders will be deeper than the bottom chord and bracing members may be attached to only one flange of the chords.

#### **Grade of Steel**

Grade S355 steel should be used for the main members with Grade S275 or S235 used only for members carrying insignificant load, unless the truss has to be fabricated in a country where there is no ready supply of higher grade steel. For a truss designed using Grade S355 steel, the amount of Grade S275 or S235 steel used would normally be about 7%. For very long spans higher grades will be



economical, e.g. quenched and tempered steel or thermo-mechanically processed steel with yield strength 500 - 600 MPa, provided that fatigue is not governing.

### **Compression Chord Members**

These members should be kept as short as possible and consideration given to additional bracing if economical.

The effective length for buckling in the plane of the truss is normally not the same as that for buckling out of the plane of the truss. This effect can be further complicated in through trusses where horizontal bracing may be provided at mid panel points as well as at the main nodes. When making up the section for the compression chord, the ideal disposition of material will be one that produces a section with radii of gyration such that the ratio of effective length to radius of gyration is the same in both planes. In other words, the member is just as likely to buckle horizontally as vertically.

Eurocode 3: Part 1.1 [1] permits the effective length factors for truss members to be determined by analysis. Otherwise very conservative values are given of 1,0 and 0,9. However, as Eurocode 3: Part 1 applies to buildings, which have relatively small span trusses where absolute economy in steel weight is not vital, it is assumed that the clause is not appropriate to bridges. It is anticipated that the effective length of bridge truss members will be covered in Part 2 of Eurocode 3 [2]. As an example of current practice see Table II of BS5400 Part 3 [3].

In the case of semi-through bridges, the top chord is supported laterally by the diagonals and behaves as a strut supported on springs. The method of determination of its effective length is given in the appropriate bridge codes.

The depth of the member needs to be chosen so that plate dimensions are sensible. If they are too thick, the radius of gyration will be smaller than it would be if the same area of steel was used to form a larger member using thinner plates. The plates should be as thin as possible without losing too much area when the effective section is derived.

Trusses with spans up to about 100m often have open section chords, usually of "top-hat" section, see Figure 5. Here it is often desirable to arrange for the vertical posts and struts to enter inside the top chord member, thereby providing a natural diaphragm and also, usually, avoiding the need for gussets at alternate nodes, although packs will be needed.

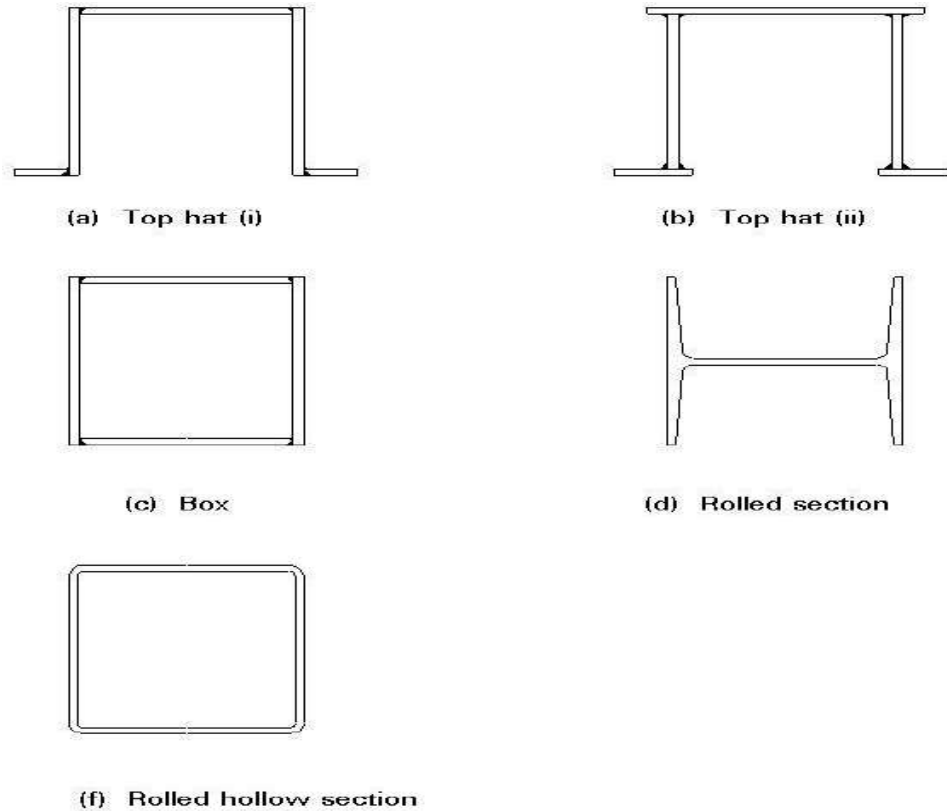

Figure 5 Compression chord members

For trusses with spans greater than about 100m, the chords will usually be box shaped so allowing the ideal disposition of material to be made from both economic and maintenance viewpoints.

For shorter spans rolled sections or rolled hollow sections may occasionally be used.

Advantages and disadvantages and comments on fabrication of the five alternative configurations shown in Figure 5 are:

a. Top Hat (i)

- Welding distortion may be a problem although the situation at the bottom flange may be improved by adding a sealing fillet. This provision is recommended to avoid corrosion.
- Welds need to be ground flush at gusset positions.
- Battens or lacing are required as local bracings.

b. Top Hat (ii)

- More suitable for automatic welding than Top Hat (i). Requires machining at nodes to allow entry of verticals and gussets.
- For fatigue reasons keep toes of fillets at least 10mm from edges of plates.
- Battens or lacing required.
- Keep outstand of bottom flange large enough to permit direct attachment of top lateral system.

#### c. Box

- Provides optimum buckling strength.
- Provides clean profile and easy maintenance.
- No lacing required.
- Access for installation of internal diaphragms is difficult.
- Additional gussets required for attachment of top laterals.

#### d. Rolled Sections

- Bad for trapping dirt and debris.
- Packing required at joints as nominal section depths vary slightly.

#### e. Rolled Hollow Sections

- Crevices are formed at gussets unless special precautions are taken.

#### **Tension Chord Members**

Tension members should be as compact as possible, but depths have to be large enough to provide adequate space for bolts at the gusset positions. The width out of the plane of the truss should be the same as that of the verticals and diagonals so that simple lapping gussets can be provided without the need for packing.

It should be possible to achieve a net section about 85% of the gross section by careful arrangement of the bolts in the splices. This means that fracture at the net section will not govern for common steel grades.

As with compression members, box sections would be preferable for ease of maintenance but open sections may well prove cheaper.

Four alternative configurations are shown in Figure 6.

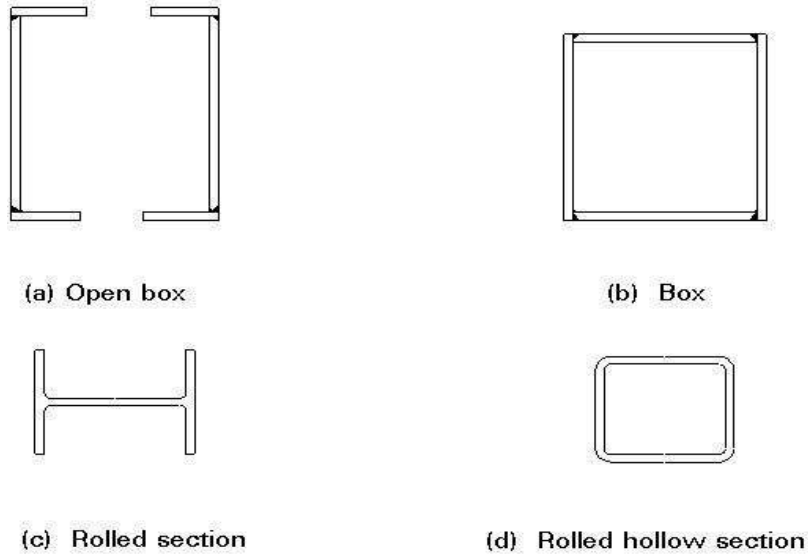

Figure 6 Tension chord members

Their advantages and disadvantages are:

a. Open Box

- Welding distortion may be a problem but could be improved by adding sealing fillets at the corners. Welds need to be ground flush at gusset positions.
- Battens or lacing required.

b. Box

- Provides clean profile and easy maintenance. No bottom plates required. Access for installation of internal diaphragms is difficult.

c. Rolled Section

- Bad for trapping dirt and debris. Packing required at joints.

d. Rolled Hollow Section

- Crevices formed at gussets unless special precautions are taken.

**Vertical and Diagonal Members**

These members should be all the same width normal to the plane of the truss to permit them to fit flush with or to be slotted inside the top chord (where the top-hat section is used) and to fit flush with the bottom chord. However, the width of the

diagonals in the plane of the truss should be reduced away from the supports by about 75mm per panel. This reduction may mean that some members are understressed. It is often possible to use rolled sections, particularly for the lightly loaded members, but packs will probably be required to take up the rolling margins. This fact can make welded members more economic, particularly on the longer trusses where the packing operation might add a significant amount to the erection cost.

Aesthetically, it is desirable to keep all diagonals at the same angle, even if the chords are not parallel. This arrangement prevents the truss looking over-complex when viewed from an angle. In practice, however, this is usually overruled by the economies of the deck structure where a constant panel length is to be preferred.

Five alternative configurations are shown in Figure 7.

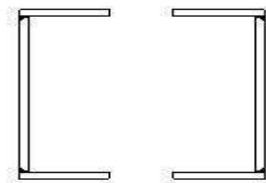

(a) Open box (i)

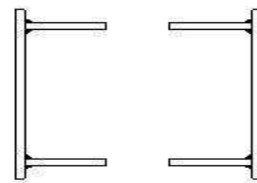

(b) Open box (ii)

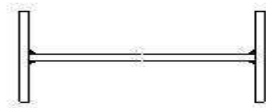

(c) Made-up I



(d) Rolled section

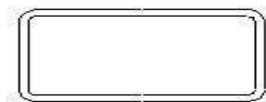

(e) Rolled hollow section

Figure 7 Diagonal and vertical members

Their advantages and disadvantages are:

a. Open Box (i)

- The partial penetration welds are expensive and alternative (ii) might be cheaper.
- Battens or lacing required.

b. Open Box (ii)

- Continuous or intermittent fillet welds can be laid simultaneously. Intermittent welds should only be used in bridges when corrosion is not a significant problem.
- Battens or lacing required.

c. Made-up I

- Not recommended for end diagonals as it acts as a water chute down to the bearings.

d. Rolled Sections

- Packing required at joints as nominal section depths vary slightly.

e. Rolled Hollow Sections

- Crevices form at gussets unless special precautions are taken.

**Maintenance**

As with any structural design, the problems that may confront the maintenance team should be fully appreciated. The problems can be numerous, but a good design will avoid most of the common difficulties. For example:

Water

- Try to keep water out but always assume it is going to get in and provide a way for it to escape when it does. "Sealed" sections should be provided with a drainage hole at the lowest point.

Dirt and Debris

- Try to keep dirt and debris out, remembering that wind and rain will bring them in.

Painting

- Remember that, if access is difficult, the bridge will not be painted or at least only badly, and probably not inspected. Box sections make painting easier, but rolled hollow sections leave nasty crevices at gusset positions, unless the joints are welded.

Birds

- Birds will nest and roost in the most unlikely places!

## 4. LATERAL BRACING

Unless an orthotropic or concrete deck is provided, stringer bracing, bracing girders and chord lateral bracing are needed to transmit the longitudinal live loads and the wind and/or earthquake loads to the bearings and also to prevent the compression chords from buckling. When a solid deck is used, the interaction between deck and trusses has to be considered.

For the lateral bracing of the chords, where a "Saint Andrew's Cross" type system as shown in Figure 8a is adopted, the nodes of the lateral system will coincide with the nodes of the main trusses. Interaction will take place which must be taken into account. As a result of the interaction, the lateral system may carry as much as 6% of the total axial load in the chords.

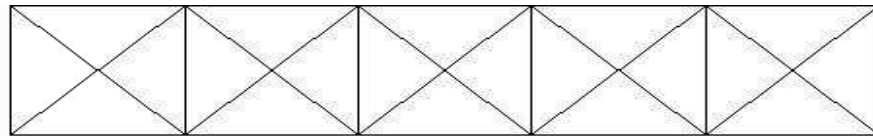

(a) St. Andrew's cross system (not recommended)

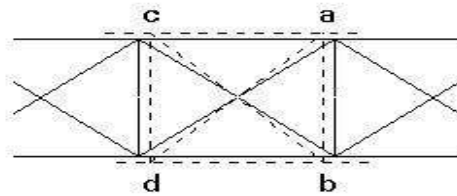

(b) Deformed shape of (a)

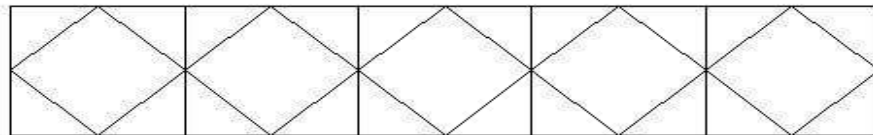

(c) Diamond system (recommended)

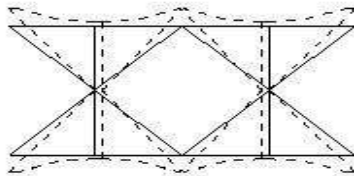

(d) Deformed shape of (c)

Figure 8 Upper chord lateral bracing

Figure 8b shows the lateral system in its original form and in its distorted form after axial compressive loads are applied in the chords. Owing to the shortening of the chord members ac and bd, the rectangular panel deforms as indicated by the dotted lines, causing compressive stresses in the diagonals and tensile stresses in the transverse members. The transverse bracing members are indispensable for the correct performance of a St Andrew's cross bracing system.

The interaction can be significantly reduced by using a "Diamond" system of lateral bracing where the nodes of the lateral system occur midway between the nodes of the main trusses, Figure 8c. With this arrangement, "scissors-action" occurs when the chords are stressed, and the chords deflect slightly laterally at the nodes of the lateral system.

In the principal buckling mode of a "Diamond" lateral bracing system, one half of the diamonds have all their members in tension (see Figure 9). For the top laterals a diamond system with kickers at the panel points halves the transverse effective length of the compression chord as shown in Figure 10.

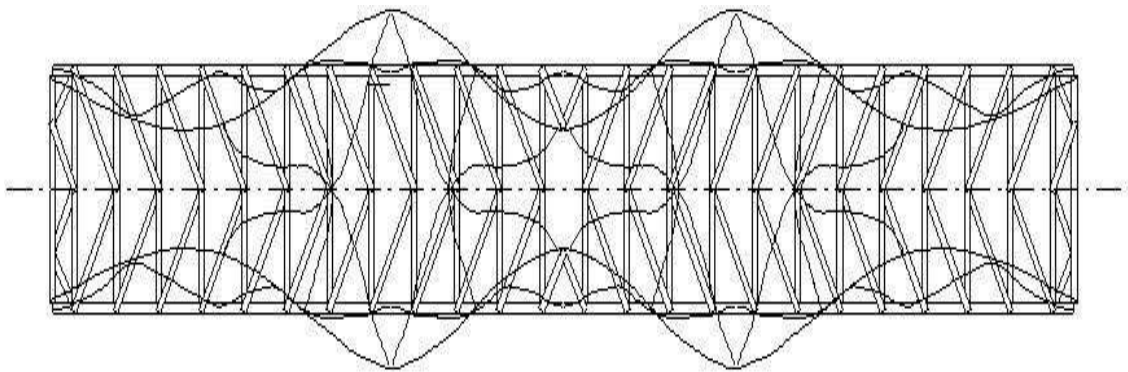

Plan: upper chord

Note: Truss webs, upper chord and its lateral bracing  
shown as solid lines for clarity

Figure 9 Buckling mode of a diamond system  
used as upper chord lateral bracing.



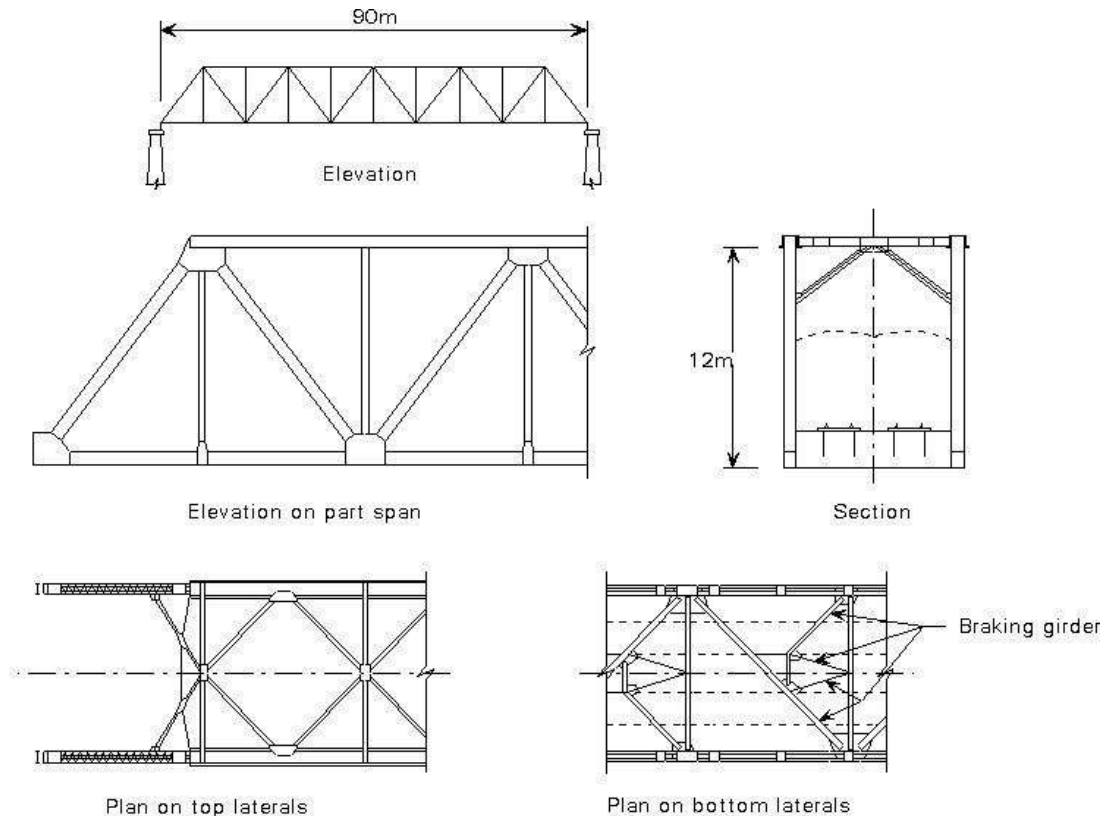

Figure 10 General arrangement of a through truss railway bridge.

For railway bridges, Figure 9 illustrates an economic lateral system at deck level which consists of a simple single member which also functions as part of the braking girder. The additional girders help to resist the braking forces arising from trains. In addition the lateral is supported by the stringers so the effective length is only about a third of the panel length.

Wind loading on diagonals and verticals can be split equally between top and bottom lateral systems. The end portals (either diagonals or verticals) then have to carry the load applied to the top chord down to the bottom chord.

Clearly, where only one lateral system exists (as in semi-through or underslung trusses), then this single system must carry all the wind load.

In addition to resisting externally applied transverse loads due to wind, etc. lateral bracing stabilizes the compression chord. The lateral bracing ensures that reasonably small effective lengths are obtained for the truss members. Local lateral bracing is also required at all 'kinks' in the chords where compressive loads are induced into the web members irrespective of whether the chord is in tension or compression because of the angular direction change of the chord.

## 5. ANALYSIS

### Global Load Effects

Generally trusses have stiff joints. The secondary stresses due to joint stiffness and truss deformation can be ignored in the ultimate limit state check. They have to be considered where the serviceability limit state check is required, and for fatigue. However, these secondary effects are generally insignificant.

The serviceability check is not required for tension members or for some slender compression members. Where it is not required, the traditional manual method of truss analysis assuming pin joints is adequate for global analysis.

Computer analysis can take joint stiffness into account and secondary moments are determined automatically. The effects of the primary axial loads and the secondary moments are combined by the use of suitable interaction formulae.

In a statically indeterminate truss, temperature effects have to be considered. They are usually not significant.

### Local Load Effects

#### i. Loads not applied at truss joints

Two types of local load effects have to be considered:

- a. Those due to loads applied in the plane of the truss away from a joint. A typical example of this type of loading is on the upper chord of an underslung railway bridge where the sleepers rest directly on the top flange of the chord.
- b. Eccentric loads not in the plane of the truss, such as loads from cross girders.

#### ii. Eccentricities at joints

Flexural stresses due to any eccentricity at joints have to be taken into account by sharing the moments due to eccentricity between the members meeting at joints in proportion to their rotational stiffness. For the main trusses the centroidal axes of all members should meet at a point wherever possible. The only case where a small degree of eccentricity is unavoidable is when asymmetrical "top-hat" sections are used and it is not possible for the centroidal axes of adjacent members of different sizes to be co-linear.

Where possible the axes of the lateral systems should be in the same planes as those of the truss chords. However sometimes the upper laterals of a through truss have to be connected to the top flange of the upper chord and eccentricity is

unavoidable. Since the loads in upper lateral systems are generally small, the additional resulting stresses are insignificant. Similarly on some through bridges, the bottom laterals have to be connected to the bottom flange of the lower chord to avoid the cross girders and stringers.

## 6. CONNECTIONS

### General

The major connections in bridge trusses occur at the truss nodes where the web members are connected to the chord members. This connection usually incorporates a splice in the chord member and sometimes also in one or both of the minor truss connections joining the cross girder and the lateral system to the truss.

Site connections can be made by high strength friction grip bolts for reasons of economy and speed of erection. Good site welds are difficult to achieve where access is difficult and fatigue life of welded joints is lower than that of bolted joints.

However, in several countries, the connections are now usually butt-welded on site. Figure 11 shows different gusset geometries which are used to obtain durability in view of the fatigue-governing effects.

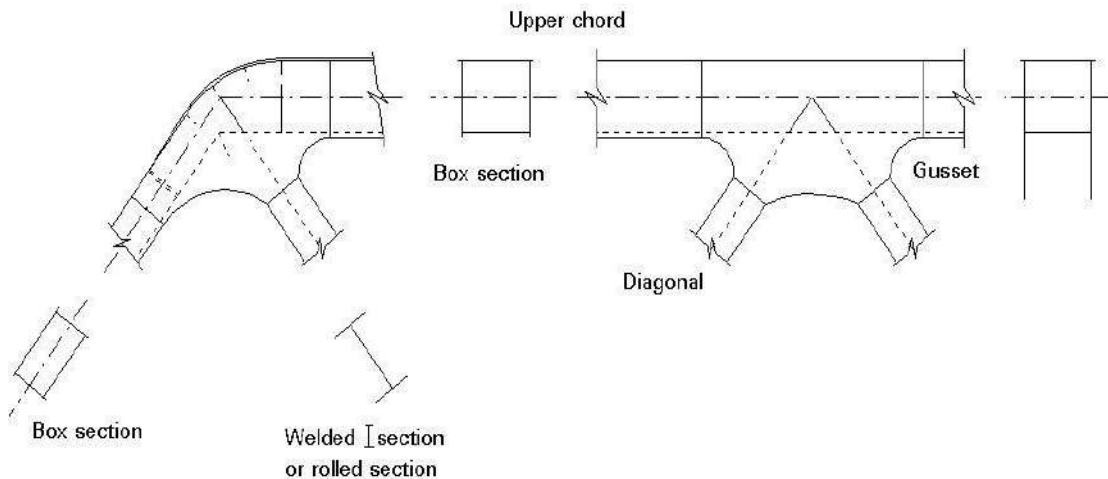

Figure 11 Butt-welded connections and gusset geometries used to avoid fatigue in the connection.

When a concrete slab is cast in place to support the highway or the railway, the horizontal forces caused by the shrinkage of the concrete should be taken into account in the design of the lower chord connection joints.

## Truss Joints

At the nodes of a truss where the web members are connected to the chords, there is a change in load in the chord which necessitates a change in its cross-section area. The node is, therefore, the point at which there is a joint in the chord as well as being the connection point of the web members.

The web members are connected to the chords by vertical gusset plates. They are usually bolted to the chord webs and the web members fit between them (Figure 12a).

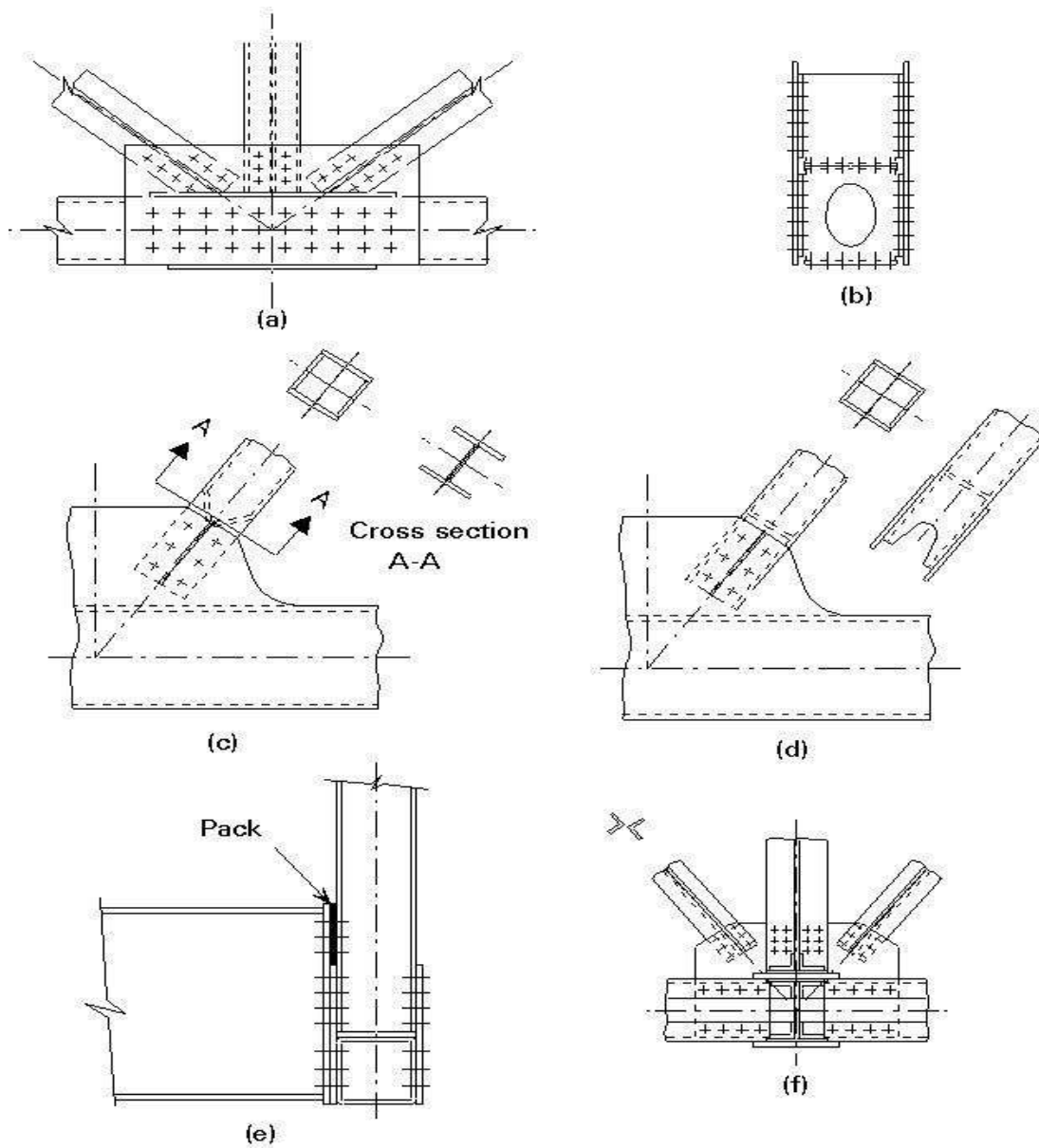

Figure 12 Bolted connections

The chord joint is effected by providing cover plates. They should be so disposed, with respect to the cross-section of the member, as to transfer the load in proportion to the respective parts of the section (Figure 12b). The gusset plates form the external web cover plates. Since they work in the dual capacity of cover plate and web connector, their thickness takes this into account. The joint is designed to carry the coexistent load in the lesser loaded chord plus the horizontal component of the load in the adjacent diagonal. The load from the other diagonal is transferred to the more heavily loaded chord through the gussets alone. In compression chords which have fitting abutting ends in contact, design codes allow up to 75% of the compressive load to be carried through the abutting ends.

Sometimes the gusset is formed by shop-welding a thicker shaped plate to the chord in place of the chord web. The web members are then all narrower than the chords and the chord splice is offset from the node. An advantage occurs in erection as the web connections can be made before the next chord is erected.

At the connections of all tension members and elements, care has to be taken in the arrangement of bolt holes to ensure that the critical net section area of the section is not so small that fracture will govern. If necessary staggering the lines of bolts helps to increase the effective net area. Remember that the critical net section is usually at the ends of the section or the centre of the cover plates, and that elsewhere some of the load has been transferred to the other parts of the joint and more bolt holes can be tolerated.

Connections of web members to gussets are quite straightforward and special treatment such as the use of lug angles is rarely required. In connecting rectangular hollow sections the method shown in Figure 12d is preferable to that of Figure 12c.

Unsupported edges of gussets should be such that the distance between connections does not exceed about 50 times the gusset plate thickness (Figure 12a). If this is unavoidable, the edge should be stiffened.

#### **Cross Girder Connections**

They are quite straightforward. The 2 or 4 rows of bolts in the cross girder end plate are made to correspond with the equivalent central rows of bolts in the gusset. Packing plates may be required to accommodate the difference in height of gussets and cross girders (Figure 12e).

#### **Lateral Bracing Connections**

As recommended in 5.2(ii) the axes of the lateral systems should be in the same planes as those of the truss chords. This requirement is met in 2 of the 3 types of lateral members and connections described below:

- i. For long and medium spans, the lateral members are frequently made from two rolled channel sections connected by lacing to give an overall depth the same as the chords. They are connected to the chords by gussets bolted to the chord flanges exactly as the main web members are connected to the main joint gussets.
- ii. For medium spans, laterals consisting of two rolled angles arranged toe to toe in "star" formation and with intermediate battens are often ideal. They are connected to the chords by gussets positioned at the chord axis (Figure 12f). Note, angles "back-to-back", but separated by a small gap should never be used because of maintenance problems.
- iii. On short spans single laterals often suffice. They can be connected by a gusset to the upper or lower chord flange, as the moments due to eccentricity are small.

# UNIT – V

## DESIGN OF STEEL BUNKERS AND SILOS

### INTRODUCTION

Bins are used by a wide range of industries throughout Europe to store bulk solids in quantities ranging from a few tonnes to over one hundred thousand tonnes. Bins are also called bunkers and silos. They can be constructed of steel or reinforced concrete and may discharge by gravity flow or by mechanical means. Steel bins range from heavily stiffened flat plate structures to efficient unstiffened shell structures. They can be supported on columns, load bearing skirts, or they may be hung from floors. Flat bottom bins are usually supported directly on foundations.

For structural design, it is convenient to classify bins using the BMHB system [2] into the following four categories:

Class 1 Small bins holding less than 100 tonnes, are simply and robustly constructed often with substantial reserves of strength.

Class 2 Intermediate bins, between 100 and 1000 tonnes, can be designed using simple hand calculations. Care is required to ensure reliable flow and predictable wall pressures.

Class 3 Large bins, over 1000 tonnes. Specialist knowledge of bins is required to prevent problems due to uncertainties of flow, pressure and structural behaviour. Sophisticated finite element analyses of the structure may be justified.

Class 4 Eccentrically discharging bins where the eccentricity of the outlet  $e_o$  is greater than 0,25 times the silo diameter,  $d_c$ .

#### **Bin design procedures consists of four parts as follows:**

- i. Determine the strength and flow properties of the bulk solid.
- ii. Determine the bin geometry to give the desired capacity, to provide a flow pattern with acceptable flow characteristics and to ensure that discharge is reliable and predictable. Specialised mechanical feeder design may be required.
- iii. Estimate the bin wall loads from the stored material and other loads such as wind, ancillary equipment, thermal, etc.
- iv. Design and detail the bin structure.

### BIN CLASSIFICATION

For design purposes, bins are classified by their size, geometry, the type of flow during discharge of the contents, and the structural material of the wall. The importance of each of these parameters in design is discussed below.

## 2.1 Bin Size and Geometry

The bin size and geometry depend on the functional requirements such as the storage volume and the method and rate of discharge, the properties of the stored material, available space and economic considerations. Bins usually consist of a vertical sided section with a flat bottom or a bottom with inclined sides, known as the hopper. They are usually circular, square or rectangular in cross-section and may be arranged singly or in groups. Typical bin geometries are shown in Figure 1.

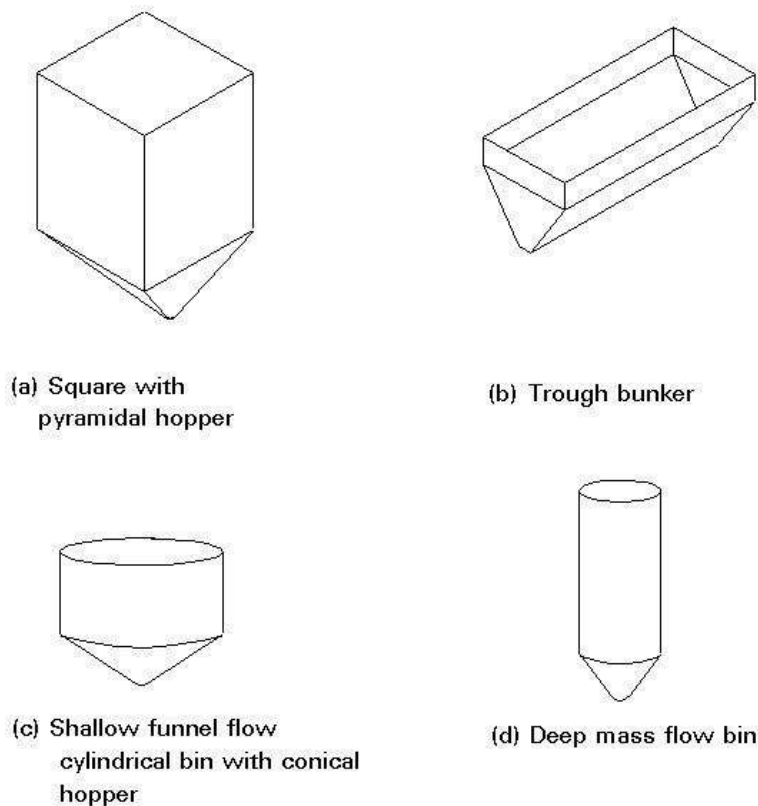

Figure 1 Typical bin geometries

Circular bins are more efficient structures than square or rectangular bins, leading to lower material costs. For the same height, a square bin provides 27% more storage than a circular bin whose diameter equals the length of the side of the square bin. Flat-bottom bins require less height for a given volume of stored material.

The bin size is determined by feeding and discharge rates and the maximum quantity of material to be stored. High discharge rates require deep hoppers with



steep walls. Flat bottomed bins usually have low discharge rates and are used when the storage time is long, the discharge is infrequent and the storage volume is high.

The ratio of bin height to diameter influences the loads from the stored material and hence the structural design. Eurocode 1 classifies bins as either squat or slender [1]. Squat bins are defined as those where the height does not exceed 1,5 times the diameter or smallest side length. Slender bins have a height to diameter ratio greater than 1,5.

Hoppers are usually conical, pyramidal or wedge shaped. Pyramidal hoppers have the advantage of being simple to manufacture although they may lead to flow problems due to the building up of stored material in the corners. Outlets may be either concentric or eccentric to the centre of the bin. Eccentric outlets should be avoided because the pressure distribution is difficult to predict and there may be problems due to segregation of the stored material. The angle of inclination of the hopper sides is selected to ensure continuous discharge with the required flow pattern.

## **CALCULATION OF PRESSURES ON BIN WALLS**

### **General**

Most existing theories for the calculation of loads from the stored material in bins assume that the pressure distribution around the perimeter of a bin is uniform at any given depth. In reality, there is always a non-uniformity of loading. This may arise from imperfections in the bin walls, non-concentric filling techniques, or discharge outlets positioned eccentrically to the centre of a bin.

The pressure exerted on the bin wall by the stored material is different when the material is flowing and when it is stationary. The stress state within a stored material changes as flow commences and the bin walls are subjected to high localised pressures of short duration. Research studies have identified two types of high pressure during discharge. The first is known as the kick load which occurs at the start of flow and is only significant in the hopper. The second high pressure is attributed to a local stress re-distribution within the flowing material as it passes the imperfections of the bin walls.

The neglect of the non-uniform loading in design results in more bin failures than any other causes. It leads to particular problems with circular bins which are designed to resist membrane forces only. Pressures due to eccentric discharge are erratic and may be higher or lower than the uniform pressure predicted using most existing theories.

Although high discharge pressures and their fundamental causes have been identified, they are difficult to quantify. It is common practice therefore for

designers to multiply the calculated static pressure by a constant derived from experimental data. The empirical factor has traditionally been applied to the static pressure without any regard to the structural response of the bin. Since the high discharge pressures only affect local areas, variation of the pressure may result in a worse stress state in the bin wall than a high uniform pressure. Therefore the assumption of a high but constant pressure at any level is not necessarily safe.

### ***Horizontal pressure and wall frictional pressure***

The horizontal pressure at any depth in the bin is calculated using the classical Janssen theory. Janssen considered the vertical equilibrium of a horizontal slice through the stored material in a bin (Figure 6) and obtained the following relationship:

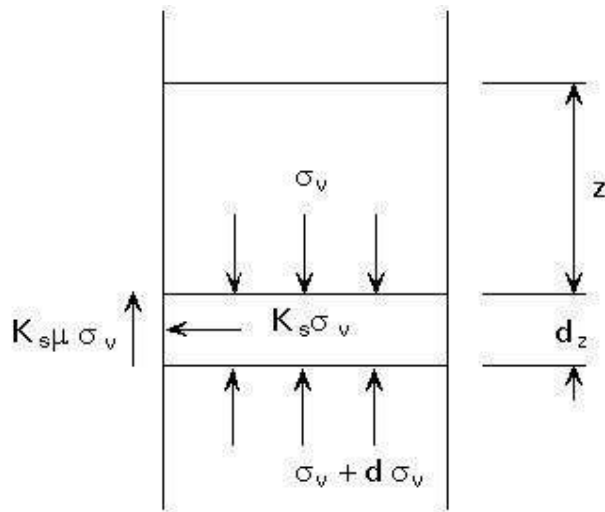

Figure 6 Stresses on a horizontal slice through the bin (Janssen's theory)

$$A(\sigma_v + d\sigma_v) + U \mu K_s \sigma_v dz = \gamma Adz + A \sigma_v \quad (1)$$

Rearranging and solving the first order differential equation gives the Janssen equation for vertical pressure  $p_v$  at depth  $z$ , the horizontal pressure  $p_{hf}$  and the wall frictional pressure  $p_{wf}$ :

$$p_v = [\gamma A / U \mu K_s] [1 - e^{-K_s \mu z U / A}] \quad (2)$$

$$p_{hf} = K_s p_v \quad (3)$$

$$p_{wf} = \mu p_{hf} \quad (4)$$

The accuracy of the method depends on the selection of a value for the ratio of horizontal to vertical pressure  $K_s$  and the coefficient of wall friction  $\mu$ .

Most bin wall pressures vary because the bins are filled with materials of different properties at different times. Other pressure changes may occur as the bin becomes polished or roughened by stored solids. Bins should therefore be designed with a variety of conditions in mind. Eurocode 1 recognises this situation and gives a range of properties for common stored materials. Material properties are selected to give the most adverse loading condition. The most adverse horizontal pressure occurs when  $K_s$  is at its maximum value and  $\mu$  is at its minimum. The most adverse wall friction load arises when  $\mu$  and  $K_s$  are both at maximum values. Material properties may be determined by testing or by taking values from Table 4.1 of Eurocode 1.

For bins with corrugated walls, allowance must be made for higher values of  $\mu$  due to the effect of the stored material within the corrugations.

For convenience Eurocode 1 gives a formula for the calculation of the axial compression force due to the wall friction pressure at any depth in a bin. The axial compression per unit perimeter at depth  $z$  is equal to the integral of the wall friction pressures on the wall above and is obtained as below:

$$P_w(z) = \int_0^z P_{wf}(z) dz = \gamma \frac{A}{U} [z - z_0(1 - e^{-z/z_0})]$$

The Reimbert method [6] is a suitable alternative to the Janssen method for the calculation of static pressures. However, it has not been included in Eurocode 1.

### ***Pressure increase for filling and discharge***

The pressures calculated using the Janssen theory are multiplied by empirical factors to give filling and discharge pressures for the following conditions:

- i. Patch load for filling.
- ii. Uniform pressure increase for discharge.
- iii. Patch load for discharge.
- iv. For simplicity of structural design, Eurocode 1 also includes a simplified alternative rule to the patch load for filling and discharge.

#### **i. a. The patch load for filling: non-membrane bins**

Pressures determined using the Janssen equation are increased by a localised load or 'patch' load to allow for unsymmetrical pressure distributions. The patch load is prescribed to account for unsymmetrical pressures which experiments have shown occur in all bins. The non-uniformity of pressure depends mainly upon the eccentricity of the bin inlet, the method of filling and the anisotropy of the stored material. The patch load increases with the eccentricity of filling. The eccentricity of filling is shown in Figure 5 and results from the horizontal velocity of the stored material. It depends upon the type of filling device and must be estimated before calculating the patch load.

The patch load is different for unstiffened steel (membrane) and stiffened steel and concrete (non-membrane) bins to allow for the differences in the response of these structures to loading. The maximum stress in the walls of non-membrane bins depends upon the magnitude of the pressure whereas membrane steel bins are more sensitive to the rate of change of pressure. For stiffened steel bins, two patch loads are applied on diametrically opposite square areas of wall, each with side length  $s = 0,2d_c$  (Figures 7a and 7b). The loads are symmetrical and allow a relatively simple calculation of the bending moments induced in the structure.

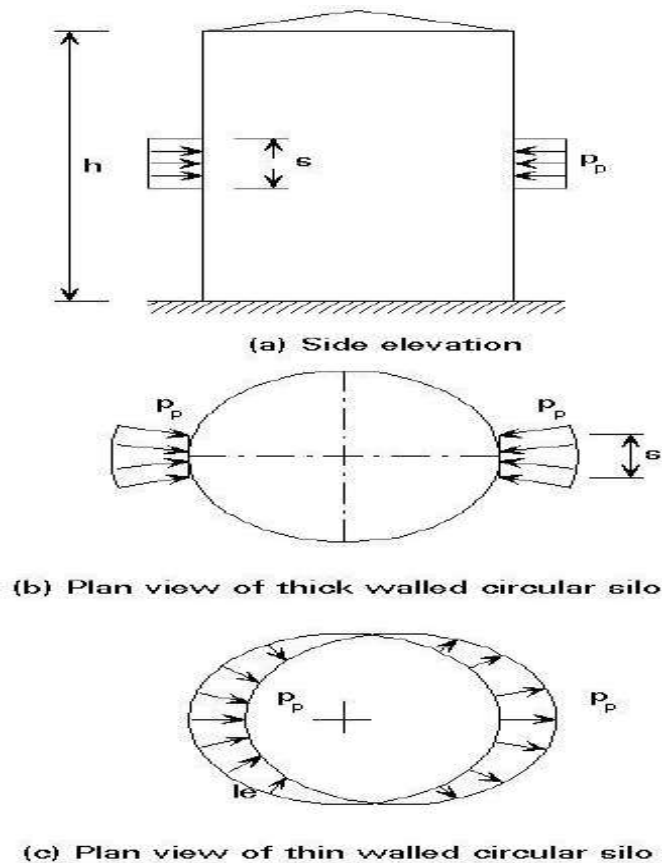

Figure 7 The patch load

The patch pressure is calculated as follows:

$$p_p = 0,2\beta p_{hf} \quad (5)$$

The pressure acts over a height  $s$ , where:

$$s = 0,2d_c \quad (6)$$

$$\beta = 1 + 0.2 e$$

The patch should be applied at different levels on the bin wall to find the worst loading case resulting in the highest wall stress. For simplicity, Eurocode 1 allows the patch load in non-membrane bins to be applied at the mid-height of the vertical walled section and uses the percentage increase in the wall stresses at that level to increase the wall stresses throughout the silo. The simplified rule does not apply to groups of silos.

### **i. b. The patch load for filling: membrane bins**

Membrane steel bins are sensitive to the rate of change of the patch pressure and so a cosine pressure distribution is specified. The pressure pattern shown in Figure 7c extends all around the bin. Pressure is outward on one side and inward on the other.

The most important influence of the patch is the increase in axial compression at the base of the bin. The increased axial compressive force can easily be calculated using beam bending theory and assuming global bending of the bin. In order to calculate the axial compressive force, the total horizontal force from the patch load should be calculated from:

$$F_p = \frac{\pi}{2} s d_c p_{ps} \quad (7)$$

where

$$p_{ps} = p_p \cos \theta$$

and  $p_p$  and  $s$  are calculated using Equations (5) and (6) respectively.

The patch should be taken to act at a depth  $z_0$  below the equivalent surface or at the mid-height of the vertical walled section, whichever gives the higher position of the load, where

$$z_0 = \frac{A}{K_s U}$$

The patch pressure introduces local bending stresses in the bin at the level of the patch. These bending stresses are difficult to calculate and a finite element analysis of the structure is required. To simplify the calculation it is easier to design using the increased pressure distribution described in iv. below as an alternative to the patch pressure.

## **ii. Uniform pressure increase for discharge**

The static pressures are multiplied by two constant coefficients ( $C_w$  and  $C_h$ ) to design for uniform discharge pressures.  $C_h$  increases the horizontal pressure and  $C_w$  increases the vertical pressure.  $C_h$  varies depending upon the stored material and Eurocode 1 gives a value that ranges from 1,3 for wheat to 1,45 for flour and fly ash.  $C_w$  is taken as 1,1 for all stored materials. These factors were selected from experience gained from satisfactory bin design and test results.

## **iii. Patch load for discharge**

The patch load for discharge is calculated in the same way as the patch load for filling. Horizontal pressures calculated for discharge (described in ii.) are used to calculate the patch load. In addition, the eccentricity  $e$ , is taken as the greater of the eccentricities of the filling and the outlet (see Figure 5).

## **iv. Increased uniform load - an alternative to the patch for filling and discharge**

For simplicity in structural design, Eurocode 1 permits the use of another constant factor on the uniform discharge pressures to allow for stress increases due to unsymmetrical pressure. The factor is calculated from the patch load magnifier and results in a simple but conservative rule which may be used instead of the patch pressure. For filling and discharge the normal wall pressure calculated using Equation (3) is multiplied by  $1 + 0,4 \beta$  and the wall friction is multiplied by  $1 + 0,3 \beta$ .

### ***Hopper and bottom loads***

Flat bottoms are defined as bin bottoms where  $\alpha < 20^\circ$ . The vertical pressure  $p_{vf}$  varies across the bottom but for slender bins it is safe to assume that the pressure is constant and equal to:

$$p_{vf} = 1,2 p_v \quad (8)$$

where:

$p_v$  is calculated using Equation (2).

It should be noted that for squat bins, the pressure variation at the bin bottom may influence the design and so flat bottomed squat bins may be designed for non-uniform pressures.

### Loads on sloping walls of hopper

Eurocode 1 considers the sloping wall (where  $\alpha > 20^\circ$ ) to be subject to both normal pressure,  $p_n$ , and friction force per unit area  $p_t$ . The hopper walls carry all the weight of the stored material in the bin other than that carried by wall friction in the vertical section. Knowledge of the vertical pressure at the transition between the vertical walled section and the hopper is required to define the loading on the hopper. Empirical formulae have been adopted in Eurocode 1 for the calculation of normal and frictional wall pressures on the hopper wall following a series of tests on pyramidal hoppers. The tests showed that it was sufficient to assume that the pressure distribution upon a hopper wall subjected to surcharge from the vertical walled section decreases linearly from the transition to the outlet. The pressure normal to the hopper wall,  $p_n$ , as shown in Figure 8 may be obtained as follows:

$$p_n = p_{n3} + p_{n2} + (p_{n1} - p_{n2}) \frac{x}{l_h} \quad (9)$$

where

$x$  is a distance measured from the edge ( $0 \leq x \leq L_h$ ) between 0, and  $l_h$

$$p_{n1} = p_{v0} (C_b \cos^2 \alpha + 1,5 \sin^2 \alpha) \quad (10)$$

$$p_{n2} = C_b p_{v0} \cos^2 \alpha \quad (11)$$

$$p_{n3} = 3,0 \frac{A \gamma K_s}{U \sqrt{K_s}} \quad (12)$$

where

$C_b$  is a constant and is equal to 1,2

$p_{v0}$  is the vertical pressure acting at the transition calculated using the Janssen equation.

The value of the wall frictional pressure  $p_t$ , is given by:

$$p_t = p_n \mu \quad (13)$$

## **Kick load**

High pressures have been measured in mass flow hoppers at the start of discharge due to a change in the stress state of the stored material. The change is often referred to as the 'switch' and results in a 'kick load' at the transition. It occurs when the material moves from a static (active pressure) to a dynamic (passive pressure) state. An empirical and approximate value for the kick load,  $p_s$ , in Eurocode 1 is given as follows:

$$p_s = 2 p_{h0} \quad (14)$$

where

$p_{h0}$  is the horizontal pressure at the base of the vertical walled section (see Figure 8)

$p_s$  is taken to act normal to the hopper wall at a distance equal to  $0,2 d_c$  down the hopper wall.

The kick load is only applied to mass flow bins. This is because it will be partially or totally absorbed by the layer of stationary material in funnel flow hoppers. The transition between the hopper, and the vertical section is subjected to a compressive inward force from the inclined hopper. The kick load acts against this compressive force and so, it may actually increase the outward load from the stored material ( $p_n$ ) which may be carried by the hopper during discharge (although the kick cannot be guaranteed and should not be used to reduce the design stresses).

## **Other Loading Considerations**

Pressure distributions can be affected by factors which may either increase or decrease wall loads. Such factors are difficult to quantify, and are more significant in some bins than others. A limited list is given below.

## **Temperature variation**

Thermal contraction of a bin wall is restrained by the stored material. The magnitude of the resulting increase in lateral pressure depends upon the temperature drop, the difference between the temperature coefficients of the wall and the stored material, the occurrence of temperature changes, the stiffness of the stored material and the stiffness of the bin wall.

## **Consolidation**

Consolidation of the stored material may occur due to release of air causing particles to compact (a particular problem with powders), physical instability



caused by changes in surface moisture and temperature, chemical instability caused by chemical changes at the face of the particles, or vibration of the bin contents. The accurate determination of wall pressures requires a knowledge of the variation with depth of bulk density and the angle of internal friction.

### **Moisture Content**

An increase in the moisture content of the stored material can increase cohesive forces or form links between the particles of water soluble substances. The angle of wall friction for pressure calculations should be determined using both the driest and wettest material likely to be encountered.

Increased moisture can result in swelling of the stored solid and should be considered in design.

### **Segregation**

For stored material with a wide range of density, size and shape, the particles tend to segregate. The greater the height of free fall on filling, the greater the segregation. Segregation may create areas of dense material. More seriously, coarse particles may flow to one side of the bin while fine cohesive particles remain on the opposite side. An eccentric flow channel may occur, leading to unsymmetrical loads on the wall. The concentration of fine particles may also lead to flow blockages.

### **Degradation**

A solid may degrade on filling. Particles may be broken or reduced in size due to impact, agitation and attrition. This problem is particularly relevant in bins for the storage of silage where material degradation may result in a changing pressure field which tends to hydrostatic.

### **Corrosion**

Stored material may attack the storage structure chemically, affecting the angle of wall friction and wall flexibility. Corrosion depends on the chemical characteristics of the stored material and also the moisture content. Typically, the design wall thickness may be increased to allow for corrosion and the increase depends upon the design life of the bin.

### **Abrasion**

Large granular particles such as mineral ores can wear the wall surface resulting in problems similar to those described for corrosion. A lining may be provided to the structural wall, but care should be taken to ensure that wall deformation does not

cause damage to the lining. The linings are usually manufactured from materials such as stainless steel or polypropylene.

### **Impact Pressures**

The charging of large rocks can lead to high impact pressures. Unless there is sufficient material to cushion the impact, special protection must be given to the hopper walls. The collapse of natural arches which may form within the stored material and hold up flow, can also lead to severe impact pressures. In this case, a preventative solution is required at the geometric design stage.

### **Rapid Filling and Discharge**

The rapid discharge of bulk solids having relatively low permeability to gasses can induce negative air pressures (internal suction) in the bin. Rapid filling can lead to greater consolidation, and the effects are discussed above.

### **Powders**

The rapid filling of powders can aerate the material and lead to a temporary decrease in bulk density, cohesiveness, internal friction and wall friction. In an extreme case, the pressure from an aerated stored material can be hydrostatic.

### **Wind Loading**

Methods for the calculation of wind loads on bins are given in Eurocode 1, Part 2 [17] and are not repeated in this lecture. Design against wind loads is especially critical during bin construction.

### **Dust Explosions**

Eurocode 1, Part 4 [1] recommends that bins storing materials that may explode should either be designed to resist the explosion or should have sufficient pressure relief area. Table 1 of the Eurocode lists materials that may lead to explosions. Other general design guidance is available [14].

Eurocode 1 recommends proper maintenance and cleaning, and the exclusion of sources of ignition to prevent explosions.

### **Differential Settlements**

Large settlements often occur as bins are filled, particularly the first time. The effects of differential settlement of groups of bins should be considered. Differential settlements may lead to buckling failure of membrane steel bins.

### **Seismic Actions**

Provisional rules for seismic design are given in Eurocode 1. These rules are beyond the scope of this lecture.

### **Mechanical Discharge Equipment**

Mechanical discharge equipment can lead to unsymmetrical pressure distributions even when it is considered to withdraw the stored material uniformly. The influence of mechanical discharge equipment on wall pressures should be considered during design.

### **Roof Loads**

Bin roofs impose an outward thrust and axial compression on bin walls and should be considered during wall design. The design of bin roofs is beyond the scope of this lecture.

### **Load Combinations**

Many bins are filled to their full design loads for most of their life. Eurocode 1 states that 100% of the predominant load should be added to 90% or 0% of other loads to give the most onerous design load at both ultimate and serviceability limit states respectively.

## **STRUCTURAL ANALYSIS AND DESIGN**

### **Selection of the Bin Form**

At the conceptual stage of design, the geometry of the bin is selected and consideration is given to the relative economy of different structural forms. The costs of materials, fabrication, erection and transport all influence the selection of the structural form. Steel bins usually have rectangular or circular cross-section shapes. Circular bins are usually more economical than rectangular bins because the circular walls carry loads in membrane tension whereas rectangular bins carry load less efficiently in bending. Rectangular bins typically require 2,5 times the material required for circular bins of the same capacity.

Rectangular bins tend to be heavily stiffened structures whereas circular bins are often unstiffened except at the top and the transition of the vertical walled section and the hopper. Rectangular bins tend to have large reserves of strength. This is not generally the case with circular bins for which care is needed in design to prevent overstress or buckling of the bin wall.

## Design of Non-Circular Bins

A typical non-circular bin is shown in Figure 9. The structural design consists of the following main procedures:

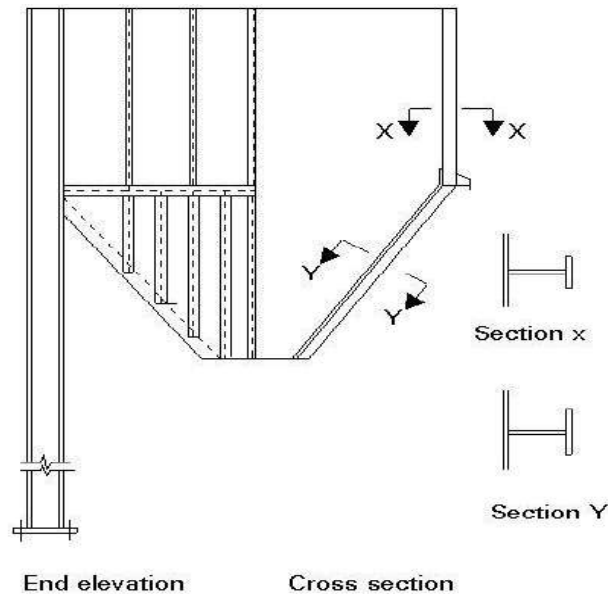

Figure 9 Typical stiffened rectangular bin : [11]

- select the support layout, stiffener layout and connections,
- design the wall plates,
- design the vertical and horizontal stiffeners including the transition ring beam,
- design the supports.

The pressures on the vertical and inclined walls are calculated using the rules outlined in Section 3. The structural design is discussed below.

### ***Wall plates***

Non-circular bins tend to be heavily stiffened structures as shown in Figure 9. Material loads in the bin are applied directly to the wall plate, and transferred via the plate to the stiffeners. The walls are subject to bending and tensile membrane stresses. Frictional forces result in vertical compression of the wall and, because of the stiff cores and column supports, cause in-plane bending of the wall.

There are two main approaches to model the structural system. Either the bin is analysed as many isolated components or it is considered as a continuous folded plate structure. Most existing guides recommend the first approach. The walls are designed with assumed boundary conditions and interaction between individual plates is ignored. The guidance given is for flat plated bins. A more economical

solution may be to use corrugated wall plates. In this case the bin wall is designed using the section properties of the corrugated sheet.

Wall pressure is carried partly by flexural action of the plate in bending and partly by membrane action. Bin walls are generally analysed using small deflection theory. The wall deflections are small (less than the thickness of the plate) and so for design purposes it is acceptable to assume that the load is carried entirely by plate bending. Three methods of analysis are commonly used. Wall plates between stiffeners with an aspect ratio greater than two to one are analysed as beams bending in one direction only. The beam is assumed to span continuously over stiffeners and may be fully fixed at the ends.

Plates with an aspect ratio less than two to one are designed with tabular data. The maximum bending moment for plates with simply supported or fixed edges is given by:

$$M_{\max} = \alpha pa^2 b \quad (15)$$

where

a and b are the shorter and longer plate dimensions respectively

p is the average normal pressure

$\alpha$  is given in Tables 1 and 2

**Table 1  $\alpha$  for plates with simply supported edges**

b/a	1,0	1,2	1,4	1,6	1,8	2,0	3,0	4,0	>5,0
$\alpha$	0,048	0,063	0,075	0,086	0,095	0,108	0,119	0,123	0,125

**Table 2  $\alpha$  for plates with fixed edges**

b/a	1,0	1,25	1,5	1,75	2,0	>2,5
$\alpha$	0,0513	0,0665	0,0757	0,0817	0,0829	0,0833

Tabulated data is not available for the analysis of trapezoidal plates and so the hopper wall is analysed as an idealised rectangular plate. The dimensions may be calculated from formulae given in Figure 10.

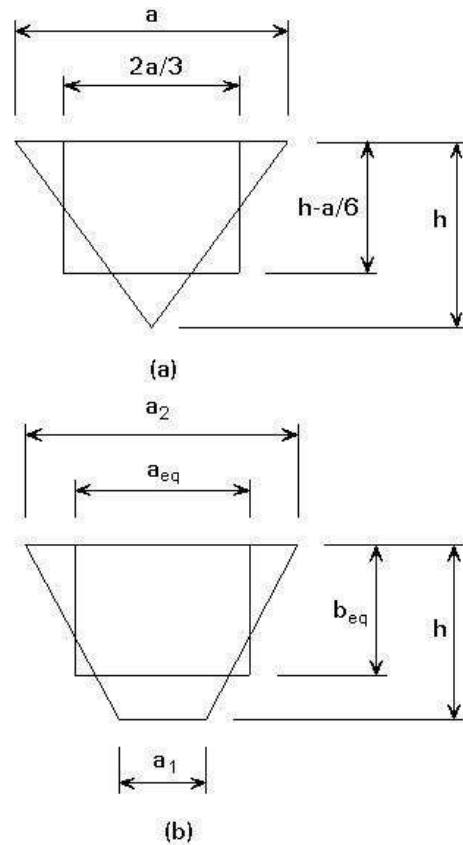

$$a_{eq} = \frac{2a_2(2a_1 + a_2)}{3(a_1 + a_2)}$$

$$b_{eq} = h - \frac{a_2(a_2 - a_1)}{6(a_1 + a_2)}$$

Figure 10 Idealised shape of trapezoidal plate : [4]

Both of the methods described lead to conservative designs due to the assumed plate geometry and boundary conditions. Higher accuracy can be achieved using numerical techniques, such as the finite element method, to analyse the interaction of the various plate members subjected to in-plane and out-of-plane loads.

### ***Plate Instability***

Buckling is unlikely to control the design of the wall thickness of plates analysed using small deflection theory. Thus a conservative stability analysis is usually adopted and the critical elastic buckling load is calculated assuming that the loads are acting in the plane of the plate. The elastic critical buckling load can be calculated from the following equation:

$$f_{cr} = \frac{k \pi^2 E}{12(1 - \mu^2) \left(\frac{b}{t}\right)^2} \quad (16)$$

The plate is assumed to be simply supported on all four edges and subject to a uniform or linearly increasing load. If necessary, the buckling resistance of a flat plate can be calculated allowing for additional strength due to lateral pressure from the stored material and post buckling strength [5].

### ***Stiffener design***

A typical stiffened arrangement is shown in Figure 9. It consists primarily of vertical stiffeners but with horizontal stiffeners at the transition and at the top of the bin. Vertical stiffeners in the vertical walled section are simply designed to carry horizontal and vertical wall friction loads from the adjoining wall plates. Stiffeners in the hopper are designed as beams with end reactions and loads normal to the wall from the stored material as shown in Figure 11. Tension forces along the beam may also need to be considered.

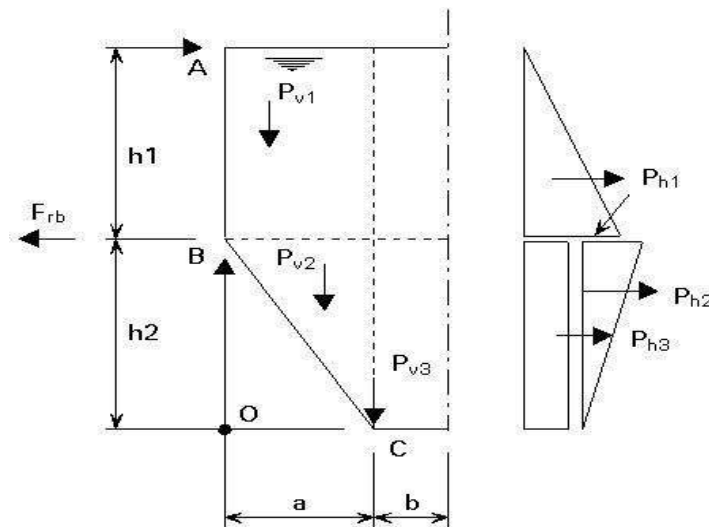

Figure 11 Bin loads and reactions

The horizontal stiffener at the top of the bin is designed to carry the reaction at A from the horizontal loads on the vertical wall. Horizontal loads include those from the stored material and the wind loads.

Hopper loads are usually carried by a ring beam at the transition. The ring beam has to carry the hopper weight and distribute the bin loads to the supports. At the start of filling the ring beam acts as a compression frame. It resists inward forces from the suspended hopper. As filling continues, the compressive forces are offset by tension from the lateral pressure exerted by the stored material in the bin. Figure

11 shows the load resultants. The ring beam force is found by taking moments about point O.

$$F_{rb} = \frac{1}{h_2} \left[ p_{v1} \frac{a}{2} + p_{v2} \frac{2a}{3} + p_{v3} a - p_{h2} \frac{2h_2}{3} - p_{h3} \frac{h_2}{2} \right] \quad (17)$$

$p_{h2}$  and  $p_{h3}$  are the horizontal components of pressure calculated normal to the hopper wall using Equation (9). The ring beam may also have to carry loads from the following:

- Vertical load from wall friction in the bin.
- Axial compressive forces that arise from in-plane bending of the wall plates.
- Axial tension due to forces from adjacent walls.
- Torsion due to eccentricity of any of the above forces.

### ***Support structure***

The support structure for small bins is usually terminated at the ring beam. The walls of the structure above carry all the loads from the bin. This form of support is common in circular bins but in square bins the supports are usually continued from the transition ring beam to the top of the structure. Their function is to carry the vertical loads in the bin and provide resistance to buckling. A small ring beam is often positioned at the top of the bin to give additional restraint against horizontal forces. The support structure is braced to provide stability against externally applied lateral forces or non-symmetrical internal forces.

### **Design of Circular Bins**

#### ***Introduction***

The wall thickness of circular bins is selected after checks to prevent yielding due to circumferential tension forces and buckling. The wall thickness of most bins is governed by buckling although hoop tension controls the design of very shallow bins. Most cylindrical bins have only two stiffeners, one at the transition and one at the top of the vertical walled section. Additional stiffeners may be used to resist wind loads. Conical hoppers are usually unstiffened.

This section describes the basic design procedure and discusses the design of critical components. The main elements of design are:

- Preliminary sizing of bin and hopper walls.
- Bin wall buckling.
- Stiffener design considering the influence on wall stresses and buckling.
- Support design considering the influence on wall stresses and buckling.



Recent research has investigated the limitations of simplified design rules and highlighted areas of design which may require careful consideration. These areas include high localised stresses around bin supports and boundaries, and the influence of unsymmetrical loads on wall stress. For very large bins a detailed finite element analysis of the structure is recommended. For most bin designs this may not be possible due to economic restrictions and so the design is carried out using simplified procedures. In many cases these procedures do not model the bin behaviour accurately and careful design is required to prevent failure.

### ***Cylinder wall stress***

The circumferential wall stresses in bins less than 5 m diameter can be first estimated simply but conservatively using the symmetrical pressure distribution alternative to the patch load discussed in Section 3.2.2 and the membrane theory of shells. Membrane theory assumes that the bin wall is subject to tensile forces only. The 'hoop' tension should be calculated at the bottom of the cylinder as follows:

$$t_h = p_{he} r \quad (18)$$

The resulting wall thickness may have to be increased to ensure adequate connection strength, corrosion and wear resistance and to prevent buckling. (Joint efficiency factors for welded connections are given in [Lecture 15C.1.](#))

Membrane theory is only accurate for the predication of wall stresses away from discontinuities such as changes in wall thickness, supports and stiffeners. Particular precautions are required depending upon the type of support. These precautions are discussed in Sections 4.3.4 to 4.3.6.

### ***Wall buckling***

The most common failure mode of cylindrical steel bins is the buckling of the bin wall under axial compression. Axial compression may be due to combined loads of wall friction, roof loads and loads from attached equipment. The elastic buckling stress of a bin wall is influenced by the following:

- magnitude and shape of wall imperfections;
- distribution of the wall friction load;
- magnitude of internal pressure;
- elastic properties of the stored material;
- connections;
- bin supports.

Buckling can be prevented using simple hand calculation methods provided that the bin walls, supports and connections are detailed carefully to prevent significant out-of-plane displacements.

Many methods have been proposed for the calculation of the critical elastic buckling stress and they are reviewed by Rotter [13]. A simple and conservative approach is to adopt the classical elastic critical stress multiplied by an empirical safety factor  $\gamma$ .

$$f_{cr} = \gamma \frac{E_t}{r} \quad (19)$$

where  $\gamma = 0,15$

The influence of lateral pressure is ignored and the shell is assumed to be uniformly axially compressed.

Equation (19) may be used safely provided that the load distribution is uniform (i.e. the conservative pressure distribution in Eurocode 1 is used) and the supports are designed to prevent significant out-of-plane stresses and deflections in the shell. The following points should be considered when designing cylindrical bin walls to prevent buckling.

- Bins can be designed less conservatively using the patch pressure distribution. The patch load results in an unsymmetrical pressure distribution around the bin wall corresponding to rapid circumferential changes in stress. A rigorous shell analysis of the bin wall is required as simple hand calculation methods are not available for an accurate analysis.
- Further economy may result from utilising the increased strength of the bin wall due to lateral pressure from the stored material. Hoop tension resulting from lateral pressure reduces the imperfection sensitivity of buckling under axial compression and increases the buckling strength. Methods have been developed to include the influence of internal pressure on the buckling strength [15]. Designers have been reluctant to use the rules because of the high number of buckling failures of steel bins and the need to ensure that the stationary layer of stored material adjacent to the bin wall has adequate thickness. In eccentrically discharged bins, the lateral support cannot be guaranteed over the entire wall and so there may not be any increase in buckling strength.
- Cylindrical walls are not normally stiffened with vertical stiffeners. The physical size of local buckles is small and so longitudinal stiffeners would need to be closely spaced to prevent buckling. Circumferential stiffeners serve no useful purpose in resisting buckling under axial compression.
- The critical buckling stress is reduced by surface imperfections. The number and size of imperfections is influenced by the fabrication process. Apparently identical cylinders fabricated using different processes may have very different buckling strengths. The critical stress should be reduced for bins with large imperfections. The ECCS recommendations [15] give rules for the strength reduction depending upon the type and size of imperfection.

- Where bolted construction is used on bins and the plates are lapped together, the buckling strength is reduced below the value for butt jointed construction. Circumferential joints lead to eccentricities in the line of axial thrust resulting in destabilizing axisymmetric deflections, compressive circumferential membrane stresses and local bending stresses.
- Column supports can induce high bending stresses in the bin wall. They can influence stresses up to a distance equal to many times the diameter from the support. The problem can be alleviated by extending the columns to the full height of the bin (the columns can then carry the roof loads directly). If the columns are not continued to the top of the bin, a shell bending analysis could be used to determine the stresses induced in the shell wall and associated ring beams and stiffeners.

### **Buckling from Wind Loads**

The ECCS [15] and BS 2654 [16] give recommendations for the design of cylinders to resist external pressure. Generally, restraint to the top of the bin is provided either by a fixed roof or a stiffener at the top of the cylinder. In large bins, it may be economical to stiffen the sheeting of circular bins. Stiffening generally increases the resistance to wind buckling, but not to circumferential tension or meridional compression, except locally. Circumferential stiffeners should be placed on the outside of a bin to avoid flow restrictions. Steel bins are more susceptible to wind buckling during construction than in service because restraint is provided by the roof and ring beam in service.

### ***Bottom and hopper***

High stresses occur near the base of a bin wall if it is rigidly connected to a flat floor. They may be reduced by detailing a suitable movement joint or by design of the bin wall to prevent overstress. Flat bottoms should be designed to carry the vertical pressure calculated from Equation (8).

Conical hoppers are designed as membrane structures in tension. For the calculation of the hopper wall thickness and connection detailing, it is necessary to calculate the meridional tensile stress and the circumferential hoop stress. The meridional tension,  $t_m$ , is calculated from the resultant of the vertical discharge pressure  $p_v$  at the transition and the combined weight of the material in the hopper and the hopper wall,  $W$ .

$$t_m = \frac{p_v r}{2 \cos(90 - \alpha)} + \frac{W}{2 \pi r \cos(90 - \alpha)} \quad (20)$$

The hoop tension  $t_h$  is calculated from the pressure normal to the hopper wall during discharge and is equal to:

$$t_h = \frac{pr}{\cos(90 - \alpha)} \quad (21)$$

The effects of mechanical discharge aids or column supports on the hopper wall stress should be considered. Again reliable hand methods for the calculation of stresses due to column supports are not available and so an accurate prediction is only possible using a finite element analysis.

### ***Transition ring beam***

The transition between the cylinder and the cone may be made using a variety of connection details (some are shown in Figure 12). The hopper applies an inward and downward force on the transition which induces a circumferential compression in the ring beam. The ring beam should be checked to prevent plastic collapse and buckling. It is a usual practice to design continuously supported rings to resist the horizontal components of the hopper meridional tension  $t_m$ . This may be reduced to allow for hoop tension from the horizontal pressure in the cylinder. The ring beam may also have to carry vertical loads for column supports.

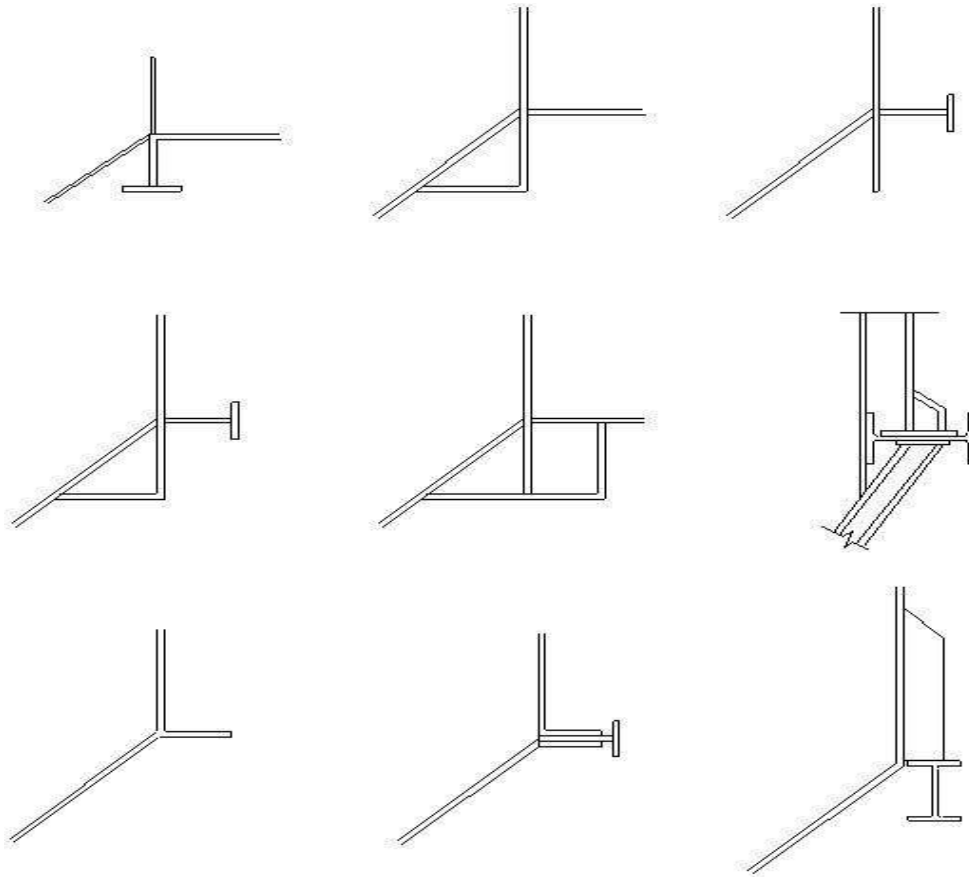

Figure 12 Typical transition ring beam details

A summary of forces on the ring beam is as follows:

- vertical load from wall friction in the cylinder;
- outward load from horizontal pressure in the cylinder;
- membrane forces from the hopper;
- torsion due to eccentricity of any of the above forces;
- upward load from the supports.

These forces result in:

- axial compression from net outward and inward forces;
- shear and bending between support columns;
- local shell bending;
- torsion due to eccentricity of shell and column loads.

Circumferential compressive stresses in the ring beam at the transition of the mass flow hoppers is relieved by the kick load. Due to uncertainty of the exact magnitude of the kick load, the beneficial effects should not be used in design.

For many ring beam details, part of the hopper and the cylinder walls are effective in carrying the ring beam forces and should be designed accordingly. For skirt supported bins, the shell provides sufficient strength and a ring beam is not usually required.

### ***Supports***

Different types of bin support are shown in Figure 13. Column supported bins result in a complicated stress pattern in the bin wall around the column. The stress pattern is less complicated when the columns are continued to the top of the bin. Increased stresses in the shell wall can be reduced by sensible design of the column support. The distance of the column from the bin wall should be kept to a minimum and loads from the column supports can be distributed by stiffeners.

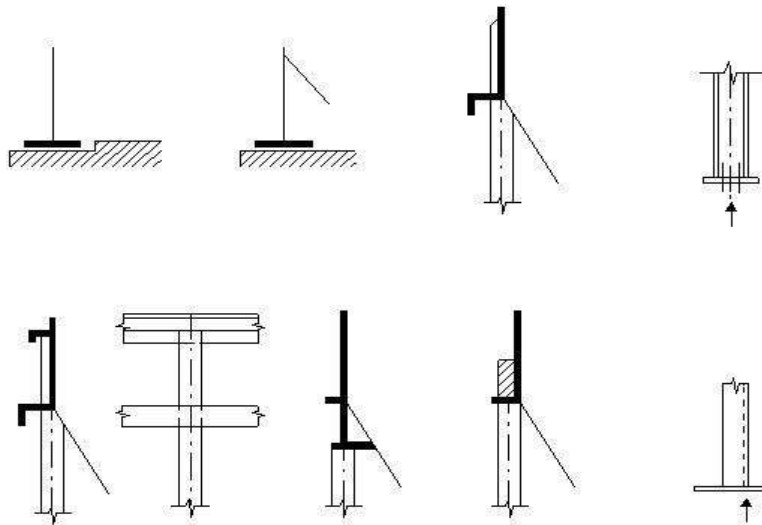

Figure 13 Typical column supports

In the case of small-diameter bins and bunkers ( $d_c < 7\text{m}$ ), the metal walls may extend down to the foundation and support the entire structure.

### ***Connections***

Sheeting may be connected by welding or bolting. When bolted connections are used, designers should be aware of the reduced buckling strength of the bin wall due to lap joints. Connections are designed to carry the meridional and circumferential stresses in the cylinder and the hopper as described above.