



GOVERNMENT POLYTECHNIC JAJPUR

**Laboratory Manual
SURVEYING-I**

Soumya Ranjan Samal

{ Lecture In Mining }

DEPARTMENT OF MINING ENGINEERING

List of Practical	
(Minimum 15 practical should be performed out of the following)	
1)	Measurement of distance by ranging and chaining.
2)	Locating various objects by chain & cross staff surveying.
3)	Determination of area of polygon by chain and cross staff survey.
4)	Measurement of bearings of sides of traverse with prismatic compass and computation of correct included angle.
5)	Locating given building by chain and compass traversing, (One full size drawing sheet)
6)	Determination of elevation of various points with dumpy level by collimation plane method and rise & fall method.
7)	Fixing bench mark with respect to temporary bench mark with dumpy level by fly leveling and check levelling.
8)	L-Section and cross section of road. (One full size drawing sheet for L-Section and cross section)
9)	Measurement of horizontal angles theodolite by method of repetition.
10)	Measurement of vertical angles with theodolite. (One full size drawing sheet)
11)	Determination of horizontal distance between two inaccessible points with theodolite.
12)	Locating given building by theodolite traversing. (One full size drawing sheet)
13)	Locating given building by plain table traversing. (One full size drawing sheet)
14)	Three point problem in plane table traversing.
15)	Determination of elevation of point by trigonometric levelling.
16)	Contour plan of given area. (One full size drawing sheet)
17)	Study of planimeter.
18)	Determination of area of irregular figure by using planimeter
19)	Study of Box Sextant, Abney Level, Optical Theodolite.
20)	To give layout of given plan of building.

AIM : Measurement of distance by Ranging and Chaining

EQUIPMENT-: Chain, Arrows, Tapes, Ranging Rods, Offset Rods, Cross staff or optical square, Plumb bob, wooden mallet, pegs.

Figure:

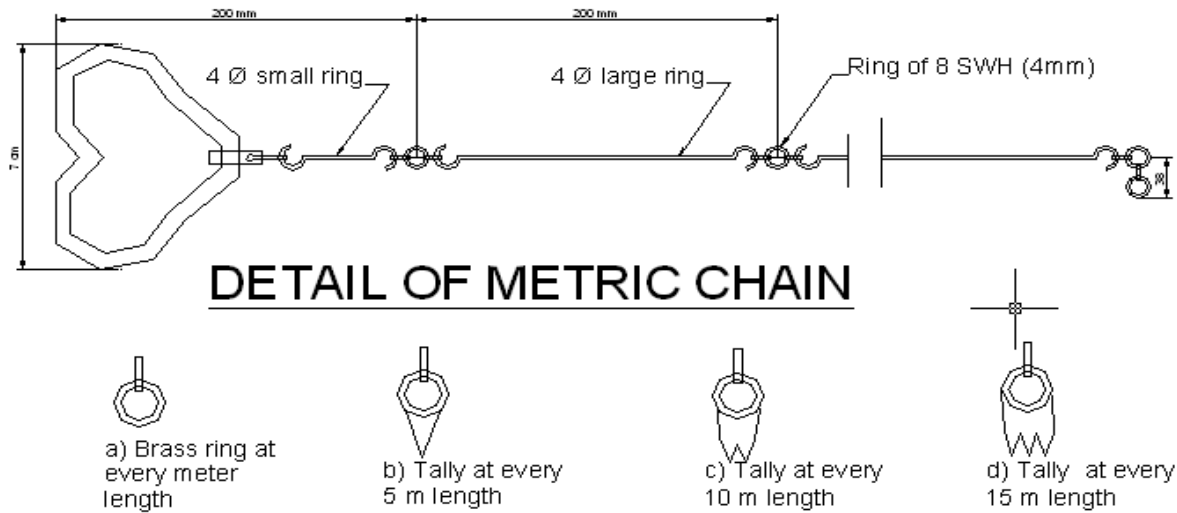

THEORY : By the various methods of determining distance the most accurate and common method is the method of measuring distance with a chain or tape is called Chaining. For work of ordinary precision a chain is used. But where great accuracy is Required a steel tape is invariably used.

The term chaining was originally applied to measure Distance with a chain. The term chaining is used to denote measuring distance with either chain or tape, In the process of chaining, The survey party consists of a leader (the surveyor at the forward end of the chain) a follower (the surveyor at the rare end of the chain and an assistant to establish intermediate points) .

The accuracy to which measurement can be made with chain and tape varies with the methods used and precautions exercised. The precision of chaining. For ordinary work, ranges from 1/1000 to 1/30,000 and precise measurement such as Baseline may be of the order of 1000000.

Survey-I

in diameter called links. The end of each link is bent into a loop and connected together by means of three oval rings which afford flexibility To the chain and make it less liable to become kinked. The ends of chain are provided with brass handles for dragging the chain on the ground, each with a swivel Joints so that the chain can be turned round without twisting. The length of the A link is the distance between the centres of the two consecutive middle rings.The end links include the handles metallic rings indicators of distinctive points of the Chain to facilitate quick reading of fractions of chain in surveying measurements.

RANGING RODS:

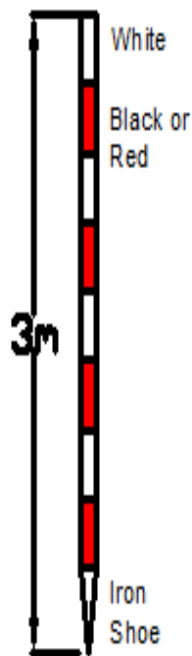

The ranging rods are used for marking the positions of Stations conspicuously and for ranging the lines. In order to make these visible at a distance, they are painted alternately black and white, or red and white or red White and black successively. The adjustment of the chain should as far as possible be affected symmetrically on either side of the middle so as that the position of central tag remains unaltered. In measuring the length of survey line also called as chain line. It is necessary that the chain should be laid out on the ground in a straight line between the end stations.

Two men are required for chaining operation; the chain man at the forward end

of chain is called the leader while the other man at the rear end is known as the follower.

Duties of leader & follower

- Leader:-**
- 1) To put the chain forward
 - 2) To fix arrows at the end of chain
 - 3) To follow the instruction of the followers.

- Follower:-**
- 1) To direct the leader to the line with the ranging rod.
 - 2) To carry the rear end of the chain.
 - 3) To pick up the arrows inserted by the leader.

Chaining 1) The follower holds the zero handle of the chain against the peg & directs the leader to be in line of the ranging rod.

2) The leader usually with two arrows drags the chain along the line.

3) Using code of signals the follower directs the leader as required to be exactly in the line.

4) The leader then fixes the arrows at the end of chain the process is repeated.

Ranging 1) Place ranging rods or poles vertically behind each point

2) Stand about 2m behind the ranging rod at the beginning of the line.

3) Direct the person to move the rod to right or left until the three ranging rods appear exactly in the straight line.

4) Sight only the lower portion of rod in order to avoid error in non-vertically.

5) After ascertaining that three rods are in a straight line, ask the person to fix up the rod.

RESULT : By Chaining and ranging the total distance is found to be _____

Survey-I





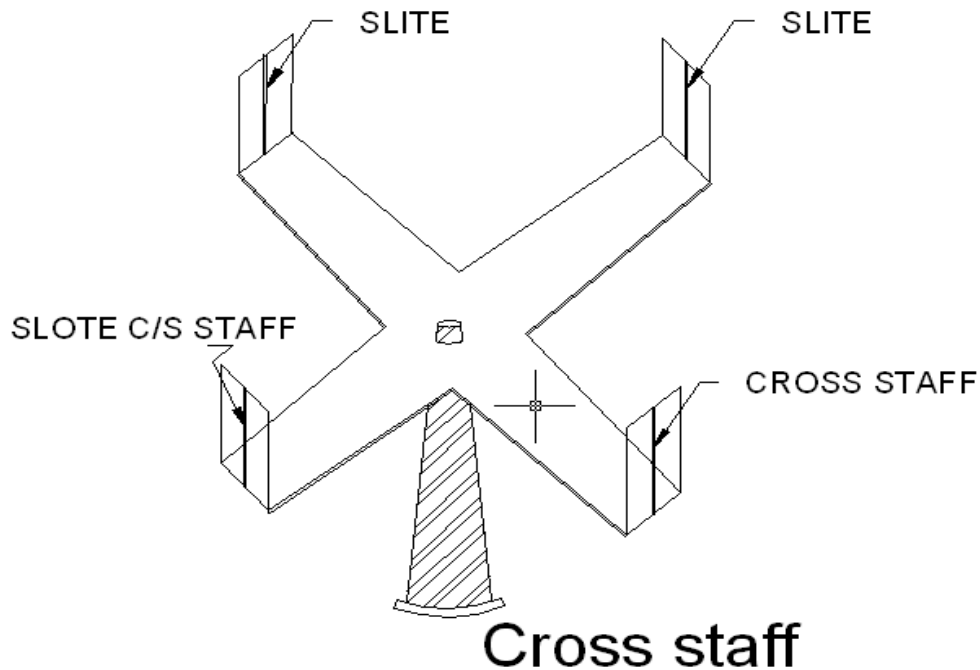





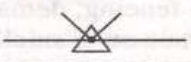
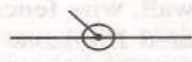

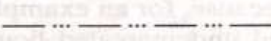

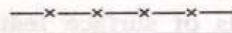







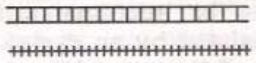
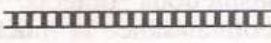
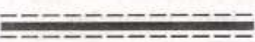
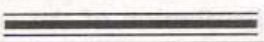

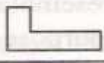
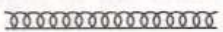





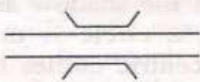
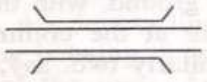
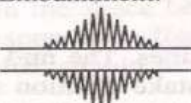
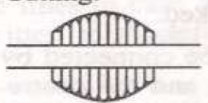
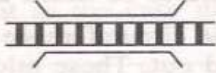



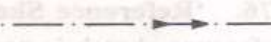

AIM : Locating various object by chain & cross staff survey

APPARATUS: Chain, Ranging rod, Arrows, Cross-staff, Metallic Survey (Tape)

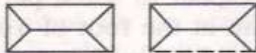

THEORY: Cross-Staff is the simplest instrument used for setting out perpendicular i.e taking offsets from a chain line. it is easier and quicker method ,but not very accurate .if great accuracy is desired ,the work should be carried out by the theodolite.

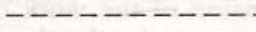
Open cross staff:- The simplest Type consists two parts 1) the head 2) the leg .the head is made of wooden block octagonal or round in shape about 15cm side or diameter an 4cm deep . on it are scribed two lines at right angles to another .At the end of these two lines are fixed two points of metallic strip having slits made in them .These slits two lines of sight which are at right angles to one another .The head is fixed on a wooden staff or pole about 3cm in diameter and 1.2 to 1.5m length .The pole is provided conical metal shoe so that it can be driven into the ground.

1. Triangulation Station. 	2. Traverse station 	3. Tie station. 	4. Chain line. 
5. Wood fencing. 	6. Pipe railing. 	7. Wire fencing. 	8. Demarcated property boundary. 
9. Undermarcated property boundary. 	10. Compound wall. 	11. Stream. 	12. River. 
13. Cart track. 	14. Canal. 	15. Railway line. 	16. Railway double line. 
17. Unmetalled road. 	18. Metalled road. 	19. Pucca building. 	20. Katcha building 
21. Hedge 	22. Trees. 	23. Woods. 	24. Orchard. 
25. Cultivated land. 	26. Swamps. 	27. Culvert. 	28. Bridge. 
29. Embankment. 	30. Cutting. 	31. Railway bridge. 	32. Temple. 
33. Mosque. 	34. Church. 	35. Pond or lake. 	36. North line. 
37. Gates. 	38. Well. 	39. Bench mark. BM 15.000 	40. Pucca drain. 
41. Katcha drain. 	42. Electric line. 	43. Shed. 	44. Gate and wall. 
45. Pasture. 	46. Cemetry 	47. Foot path. 	48. Lawn. 

1) To find the foot of the perpendicular from the object the cross staff is held approximately in position and one pair of slits is directed in the direction of the ranging rod fixed at the forward and the chain line . The observer then looks through the other pair of slits and sees whether the particular object is bisected or not. if not the cross staff is moved to and from till the necessary bisection is obtained. Before noting down the chainage of the foot of the perpendicular care must be taken to see that one pair of slit is the direction of chain or not. While shifting the position of the cross-staff it may get twisted and hence precaution is necessary.

2) To set a perpendicular to the chain line at a given point one pair of slits is oriented in the direction of chain line by looking at the ranging rod fixed at the forward and by looking through the other pair of slits ranging rod is fixed in the direction of the line of sight provided by this pair.

RESULT: Various perpendicular to the chain line object are created using cross-staff survey.

AIM : **Determination of area of given polygon by chain & cross-staff survey**

Equipment: - Two chains 20m or 30m, Arrows, Ranging rods. Cross staff or optical square, Plumb bob

THEORY : The object of cross staff survey is to located the boundaries of field or plot and to find out its area .

In this method a base line in the centre of the area is selected. Chaining along this line is done and the offsets of the points lying on the boundaries of the plot are taken at different chainages. by using a cross staff and tape on either side of the chain line and recorded against the chainages in the field note book as already discussed .The offsets length are written on the left hand side or right hand side of the line as per position until whole of the area is surveyed.

The plot is then divided into triangles and trapezoids because it is easy to find out the area of triangle and a trapezoids.

The area of the field is computed by the following formulae.

(1) The area of a right angle triangle is equal to the base multiplied by half the perpendicular

(2) The area of a trapezoid is equal to the base multiplied by half the sum of the Perpendicular.

Procedure : To start the cross staff survey ,a chain line is run through the centre of the area to be surveyed .it is divided into right angled triangles and trapezoids .The perpendicular to the boundary are taken in order of their chainages.

more than 15m .Care should be taken that no offset is overlooked before the chain is removed .The chainages of the points of intersection of the chain line and the boundaries should be recorded .The length of the boundary line may be measured by direct measurement to check the accuracy of field work.After the field work is over, the survey is plotted to some convenient scale. The figure thus formed by the boundary lines is divided in the tabular form as given below

Observation Table;-

Sr. No.	Figure	Chainage In m.	Base in (meter)	Offset in (meter)	Mean offset	Area in m ²		Remarks
						+Ve	-Ve	
1	2	3	4	5	6	7	8	9

RESULT: Area of polygon by chain & staff method is found to be -----square meter.



EXPERIMENT NO-4

AIM: Measurement of bearings of sides of traverse with prismatic compass and computation of correct included angle.

APPARATUS: Prismatic compass, ranging rod, chain, tape, peg Tripod stand , small pieces of stones.

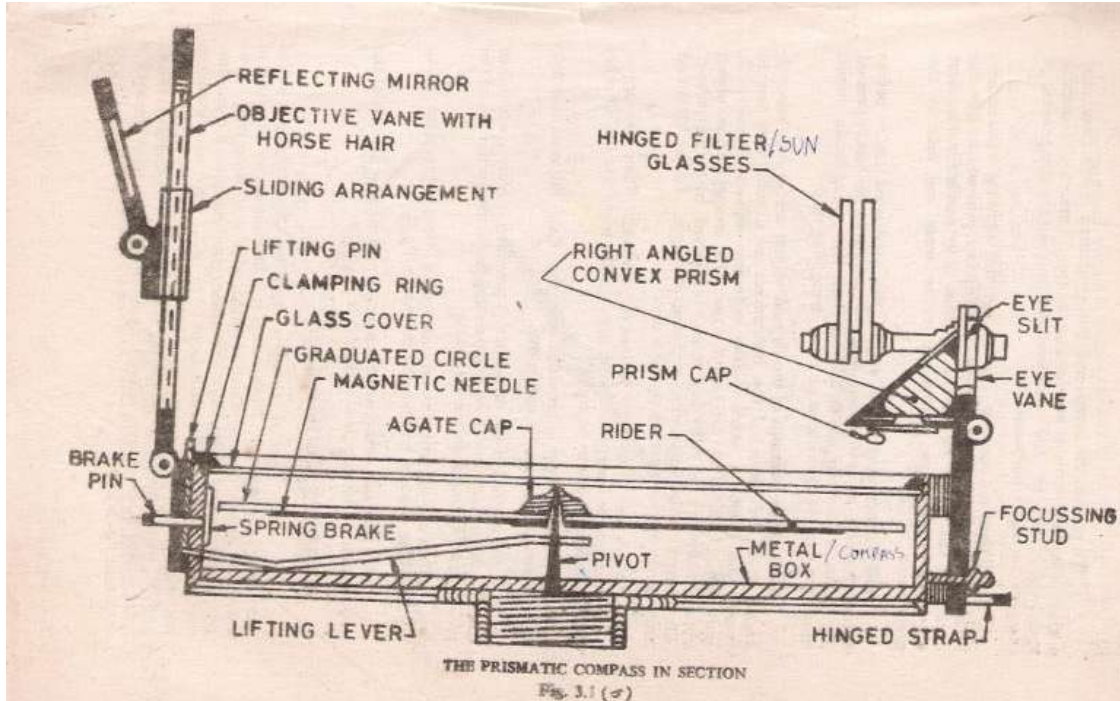
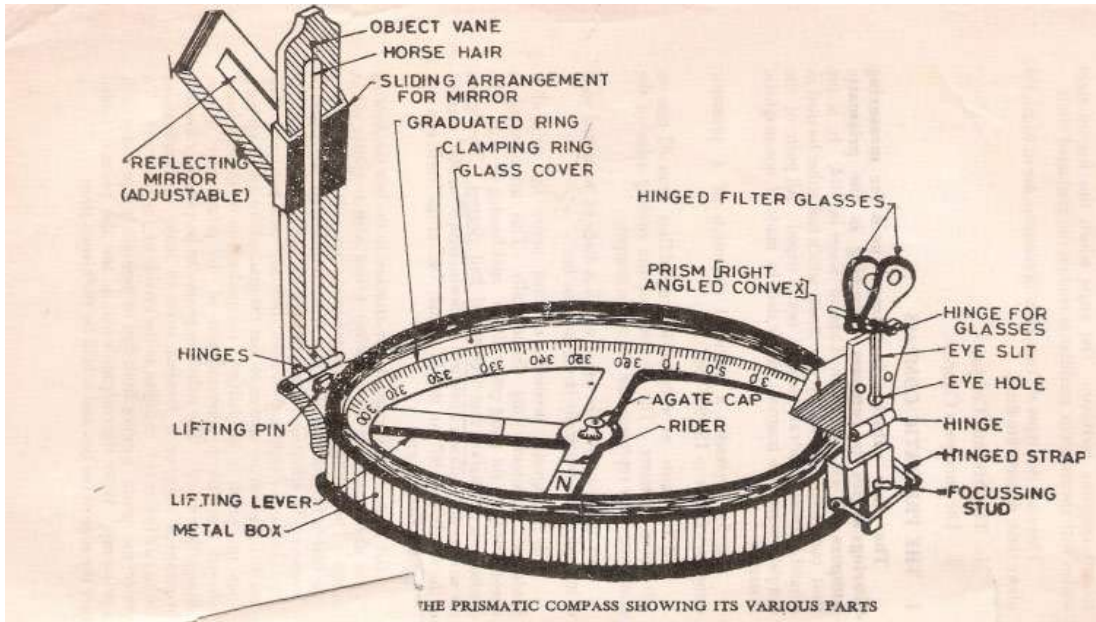

THEORY: The important parts of compass are:-

- 1) A box with graduated circle.
- 2) A magnetic needle
- 3) A line of sight

When the line of sight is pointed to point, the magnetic needle of compass points towards north (Magnetic meridian). The angle which this line of sight makes with the magnetic meridian is read on graduated circle. It is known as magnetic bearing of the line.

There are two types of compasses:-

- 1) Prismatic compass
- 2) Surveyor's compass.

Prismatic Compass:-

Prismatic compass is very valuable instrument. It is usually used for rough survey for measuring bearing and survey lines. The least count of prismatic compass is 30 min.

It consists of circular box of 10cm-12 cm dia. of non magnetic material. pivot is fixed at the centre of box and is made up of hard steel with a sharp pivot. graduated aluminum is attached to the needle. It is graduated in clockwise direction from 0° to 360° . The figures are written in inverted. Zero is written at south end and 180 at north end and 270 at the east. Diametrically opposite are fixed to the box. The sighting vane consists of a hinged metal frame in the centre of which is stretched a vertical horse hair fine silk thread of which is stretched a vertical hair. It presses against a lifting pin which lifts the needle of the pivot and holds it against the glass lid. Thus preventing the wear of the pivot point to damp the oscillations of the needle when about to take

face of the prism can be folded out the edge of the box when North end is used. Sometime the sighting vanes is provided with a hinge mirror Which can be placed upward or downwards on the frame and can be also Slided along it is required. The mirror can be made inclined at any angle so that Objects which are too high or too low can be sighted directly by reflecting.

BEARING OF LINES: A bearing of a line is a horizontal angle made by the survey line with some reference direction or meridian. Meridian may be

- 1) A true meridian
- 2) A magnetic meridian
- 3) An arbitrary or assumed meridian

True meridian: The true geographical meridian passing through a point is a line of intersection of earth's surface by a plane containing north south pole and given point. They are not parallel to each other at different places.

Magnetic meridian:-the direction indicate by a free suspended and a properly balanced magnetic needle Free from all other attractive forces. The direction of magnetic meridian can be established with the help of Magnetic compass.

Arbitrary meridian: Any direction is assumed to be the Reference meridian to Carry out small survey.

measured clockwise from the north point of the reference meridian towards the line right round the circle. The angle thus measured between the reference meridian and the line is called Whole circle bearing of the line. Angles measured will have value between 0 to 360 degrees.

Conversion of W.C.B. in R.B

Case	WCB between	R.B.	QUADRANT
1	0° TO 90°	WCB	N-E
2	90° TO -180°	$180 - \text{WCB}$	S-E
3	180° TO -270°	$\text{WCB} - 180^{\circ}$	S-W
4	270° TO 360°	$360 - \text{WCB}$	N-W

Reduced bearing (R.B): In this system of bearing of a line is measured clockwise or anticlockwise from north or south direction whichever is nearer to the line towards east or west. The concept of reduced bearing facilitates computations in traverse surveying.

Conversion of R.B in W.C.B.

Case	R.B in quadrant	Rule of W.C.B.	W.C.B between
1	N-E	$\text{WCB} = \text{R.B}$	0° TO 90°
2	S-E	$\text{WCB} = 180 - \text{R.B}$	90° TO -180°
3	S-W	$\text{WCB} = \text{R.B} + 180$	180° TO -270°
4	N-W	$\text{WCB} = 360 - \text{R.B}$	270° TO 360°

The compass may be held in hand but for better results it should be fitted at the top of tripod having ball and socket arrangement. The adjustment of a compass is done in the following three steps.

- 1) **Centering:** - The compass fitted over the tripod is lifted bodily and placed approximately on the station peg by spreading the leg of a tripod equally, The centre of the compass is checked by dropping a small piece of stone from the centre of the bottom of the compass so that it falls on the top of the station peg. A plumb bob may be used to judge the centering either by attaching it with a hook providing at the bottom or otherwise by holding it by hand.
- 2) **Levelling:**-After the compass is centred, it is leveled by means of ball and socket arrangement so that the graduated circle may swing freely.It can be checked roughly by placing a round pencil on the top of the compass, when the pencil does not move, that is roughly the horizontal position.
- 3) **Focusing the prism:** - The prism attached is moved up and down so that graduation on the graduated circle should become sharp and clear.

LOCAL ATTRACTION:

Sometimes the magnetic needle does not point towards magnetic North or South. The reason being that the needle may be under the influence of external attractive forces which are produced due to magnetic substances Thus the deflection of the needle from its original position, due to the presence of some magnetic substances is known as local attraction. To detect local attraction at a particular place, fore and back bearing of each line are taken. Then difference comes out to be 180° there is no local attraction at either station. On the other hand if the difference is other than 180° , the

presence of iron substance near to the compass. If the difference still remains the local attraction exists at on or both the stations.

Elimination of Local attraction:-

1st method: - In this method, the bearing of the other lines are corrected and calculated on the basis of the a line which has the difference between its fore bearing and back bearing equal to 180° .

The magnetic of the error is formed due to local attraction by drawing a sketch of observed and correct bearing of the line at each station. The error will be negative when the observed bearing is less than the corrected one and the correction will be positive and vice versa.

If however, there is no such line in which the difference of fore bearing and back bearing is equal to 180° , the correction should be made from the mean value of the bearing of that line in which the difference between the fore and the back bearing is the least.

If the bearings are observed in quadrantal system, the correction should be applied in proper direction by drawing a neat sketch roughly.

2nd Method: - This method is more general as the bearing at a station locally affected may be incorrect but include angles calculated from these bearing will be correct since the amount of the error will be the same for all the bearing observed from that station. Thus starting from the unaffected line and using these included angles the correct bearing of all other lines can be calculated.

Note: - The sum of the internal included angles must be equal to $(2n-4)$ right angles where n =number of sides of a closed traverse.

- 1) Four ranging rods are fixed at different points i.e. A, B, C, D, E etc. such that it should be mutually visible and may be measured easily.
- 2) Measure the distance between them.
- 1) At point A the prismatic compass is set on the tripod Stand, centering and leveling is then properly done.
- 2) The ranging rod at B is ranged through sighting slits and objective vane attached with horse hair and reading on prismatic compass is noted down.
- 3) it is fore bearing of line AB. Then the prismatic compass is fixed at B and ranging rod at C. AND A are sighted. And reading is taken as forebearing of BC and back bearing Of AB.
- 4) Repeat the same procedure at the stations C, D etc.

Observation Table

Sr. no	Line	Observed bearing	Local attraction	error	Correction	Corrected bearing	Included angle
A	AB						
B	AD						
	BC						
C	BA						
	CD						
D	CB						
	DA						
	DC						

SAMPLE CALCULATION:- Error = observed bearing –corrected bearing

Check = $(2n-4) \times 90^\circ$

RESULT: The prismatic compass is studied and bearing of lines of traverse are Observed, the correction due to local attraction at affected station is done and corrected bearings are written in tabular form.

AIM: Determination of elevation of various points with dumpy level by collimation plane

method and rise & fall method.

APPARATUS: Dumpy level, leveling staff

Figure:-

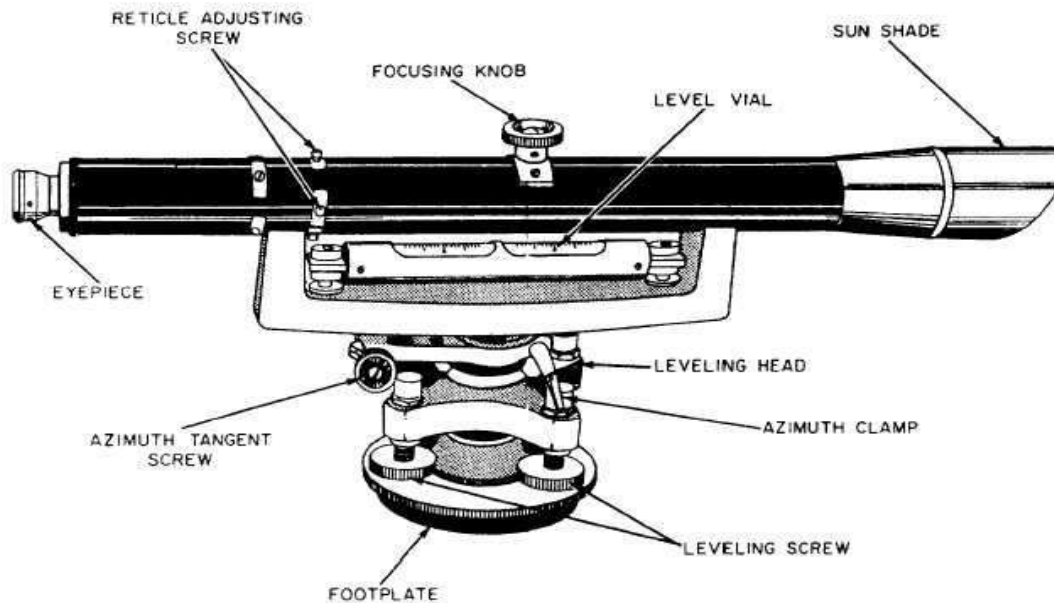

Dumpy Level

THEORY:

Levelling: The art of determining and representing the relative height or elevation of different object/points on the surface of earth is called leveling. It deals with measurement in vertical plane.

By leveling operation, the relative position of two points is known whether the points are near or far off. Similarly, the point at different elevation with respect to a given datum can be established by leveling.

LEVELLING INSTRUMENTS:- The instrument which are directly used for leveling operation are:-

Level, Levelling staff

Level: - An instrument which is used for observing staff reading on leveling staff kept over different points after creating a line of sight is called a level.

Survey-I

consists of the following points:

- 1) Levelling Heads
- 2) Limb plate
- 3) Telescope

Telescope consists of two tubes, one slide into the other and fitted with lens and diaphragm having cross hairs. it creates a line of sight by which the reading on the staff is taken

The essential parts of a telescope are

1) body 2) object glass 3) Eye-piece 4) Diaphragm 5) Ray shade 6) The rack and pinion arrangement 7) Focusing screw 8) Diaphragm screw.

- 4) Bubble tube
- 5) Tripod stand

Dumpy level:

The dumpy level is simple, compact and stable instrument. The telescope is rigidly fixed to its supports. Hence it cannot be rotated about its Longitudinal axis or cannot be removed from its support. The name dumpy is because of its compact and stable construction. The axis of telescope is perpendicular to the vertical axis of the level. The level tube is permanently placed so that its axis lies in the same vertical plane of the telescope but it is adjustable by means of captain head not at one end.

The ray shade is provided to protect the object glass. A clamp and slow motion screw are provided in modern level to control the movement of spindle, about the vertical axis. The telescope has magnifying power of about thirty diameters.

The level tube is graduated to 2mm divisions and it has normally a sensitiveness of 20

Focusing type.

Adjustment of the level

The level needs two type of adjustment

- 1) Temporary adjustment and
- 2) Permanent adjustment

Temporary adjustments of dumpy level

These adjustments are performed at each set-up the level before taking any observation.

A) Setting up the level:- this includes

- 1) **Fixing the instrument in the tripod:-** the tripod legs are well spread on the ground with tripod head nearly level and at convenient height. Fix up the level on the tripod.
- 2) **Leg adjustment:-** Bring all the foot screws of the level in the centre of their run .Fix any two legs firmly into the ground by pressing them with hand and move the third leg to leg to right or left until the main bubble is roughly in the centre. Finally the legs is fixed after centering approximately both bubbles. This operation will save the time required for leveling.

B) **Levelling:** - Levelling is done with the help of foot screws and bubbles. The purpose of levelling is to make the vertical axis truly vertical. The method of leveling the instrument depends upon whether there are three foot screws or four foot screws. In all modern instruments three foot screws are provided and this method only is described.

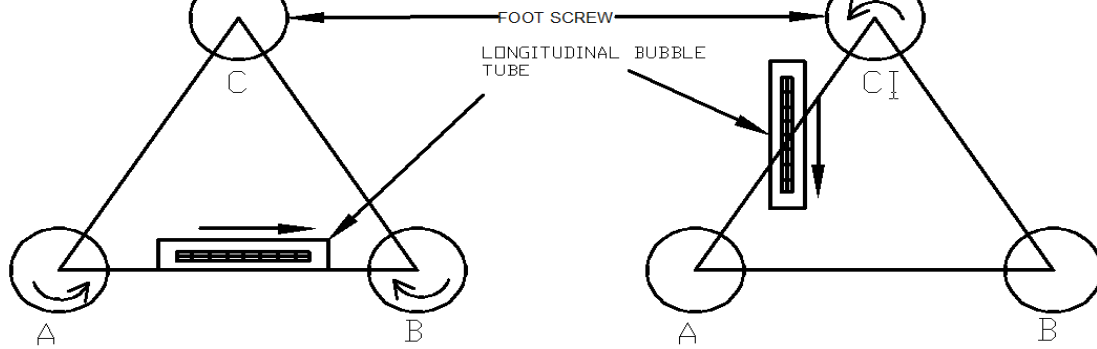

- 1) Place the telescope parallel to pair of foot screws.
- 2) Hold these two foot screw between the thumb and first finger of each hand and turn them uniformly so that the thumbs move either toward each other until the bubble is in centre.
- 3) Turn the telescope through 90° so that it lies over the third foot screw.
- 4) Turn this foot screw only until the bubble is centred.
- 5) Bring the telescope back to its original position without reversing the eye piece and object glass ends.
- 6) Again bring the bubble to the centre of its run and repeat these operation until the bubble remains in the centre of its run in both position which are at right angle to each other.
- 7) Now rotate the instrument through 180° , the bubble should remain in centre provided the instrument is in adjustment: if not, it needs permanent adjustment.

c) Focusing the eye piece:- To focus the eye piece, hold a white paper in front of the object glass, and move the eye piece in or out till the cross hairs are distinctly seen. Care should be taken that the eye piece is not wholly taken out, some times graduation are provided at the eye piece and that one can always remember the

eye piece.

(d) Focusing the object glass: - Direct the telescope to the leveling staff and on looking through the telescope, turn the focusing screw until the image appears clear and sharp. The image is thus formed inside the plane of cross hairs, Parallax, if any is removed by exact focusing. It may be noted that parallax is completely eliminated when there is no change in staff reading after moving the eye up and down.

Reduced Levels

The system of working out the reduced level of the points from staff reading taken in the field is called as reduced level (R.L) of a point is the elevation of the point with reference to the same datum.

There are two systems of reduced levels

1) The plane of collimation system (H.I. method)

2) The Rise and fall system

1) The plane of collimation system (H.I. method)

In this system, the R.L. of plane of collimation (H.I) is found out for every set-up of the level and then the reduced levels of the points are worked out with the respective plane of collimation as described below.

- 1) Determine the R.L. of plane of collimation for the first set up of the level by adding B.S. to the R.L. of B.M. i.e (R.L of plane of collimation= R.L. of B.M.+B.S.)
- 2) Obtain the R.L. of the intermediate points and first change point by subtracting the staff readings (I.S. and F.S. from the R.L. of plane of collimation (H.I). (R.L. of a point=R.L of plane of collimation H.I.-I.S or F.S)

collimation is determined by addition of B.S. to the R.L of change point. Thus the levels from two set-ups of the instruments can be correlated by means of B.S. and F.S. taken on C.P.

- 4) Find out the R.L.s of the successive points and the second C.P. by subtracting their staff readings from this plane of collimation R.L.
- 5) Repeat the procedure until all the R.Ls are worked out.

Observation table:-

Station	Reading			R.L. of plane collimation (H.I)	Reduced Level	Remarks
	B.S	I.S	F.S			

Arithmetical check: The difference between the sum of the back sights and the sum of the fore sights should be equal to the difference between the last and first reduced levels.

$$\text{i.e } \sum \text{B.S} - \sum \text{F.S.} = \text{LAST R.L} - \text{FIRST R.L}$$

2) The Rise and fall system

In this system, there is no need to determine R.L. of plane of collimation .The difference of level between consecutive points are obtained as described below.

- 1) Determine the difference in staff readings between the consecutive point comparing each point after the first with that immediately proceeding it.

the staff reading at the point is smaller or greater than that of proceeding point.

- 3) Find out the reduced level of each point by adding the rise to or subtracting fall from the R.L. of a proceeding point.

Observation table:-

Station	Reading			Rise	Fall	Reduced Level	Remarks
	B.S	I.S	F.S				

Arithmetic check:- The difference between the sum of back sight and the sum of fore sight = difference between the sum of rise and the sum of fall = the difference between the last R.L. and the first R.L.

$$\sum B.S - \sum F.S = \sum RISE - \sum FALL = LAST RL - FIRST RL$$

Inverted staff reading

When the B.M of staff station is above the line of collimation (or line of sight) the staff is held inverted on the point and reading is taken .This reading being negative is entered in the level field book with minus sign, or to avoid confusion, 'Staff inverted' should be written in the remarks column against the entry of the reading.

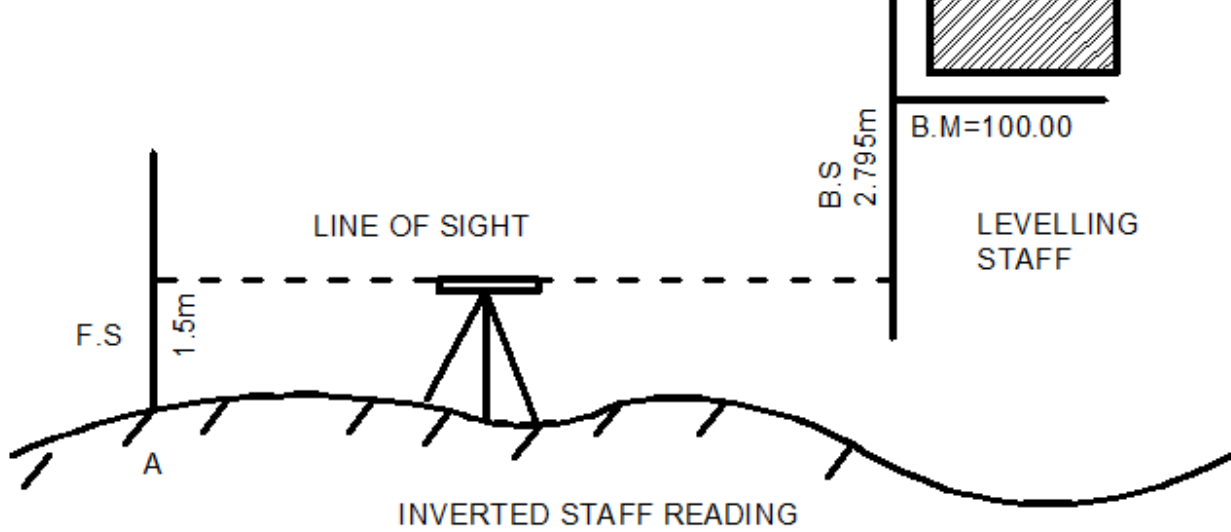

The results are tabulated as below:

B.S.	I.S	F.S	H.I	R.L	Remarks
-2.795			97.215	100.000	B.M.Staff inverted
		1.500		95.715	Point A

When the reading on the inverted staff is a foresight or intermediate sight .it should also be recorded in field book with minus sign

The R.L. of such points may be worked at as:

R.L.of the point (where the inverted staff is held)

=R.L. of H.I +F.S. or I.S.reading

RESULT:

The various reduced levels are calculated by rise and fall method and by using height or plane of collimation method and are shown in observation table.

AIM : Fixing bench mark with respect to temporary bench mark with dumpy level by fly leveling and check leveling.

Apparatus: Dumpy level, leveling staff, tripod stand, arrows, pegs

Theory:

Fly leveling: - It is a very approximate form of levelling in which distances are not measured and sights are taken as large as possible. In this method a line of levels is run to determine approximately reduced levels of the points carried out with more rapidly and less precision.

Check leveling: The main purpose of this type of leveling is to check the values of the reduced levels of the bench marks already fixed. In this method only back sight and foresight are taken. There is no need of intermediate sights. However great care has to be taken for selecting the change points and for taking reading on the change points because the accuracy of leveling depends upon these.

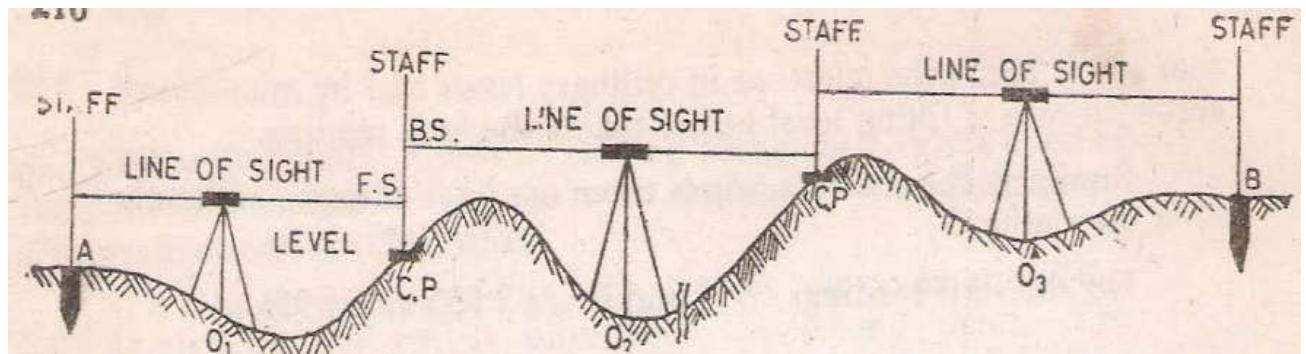

1) Let A and B the two points as shown in figure They are too far apart .The position of each set up of level should be so selected that the staff kept on the two points is visible through the telescope.

2) Let O1, O2, O3 be the positions of the level to be setup. Choose the change points 1,2 etc. on a stable ground so that the position of the level should be midway between the two staff reading to avoid error due to imperfect adjustment of the level.

3) Now setup the level at O1 take the reading on the staff kept vertically on A with bubble central. This will be a back sight and R.L of the A is assumed or say known. Record these values in the same line in the level book.

4) Now select the position of C.P (1) so that the distance of it from O1 is approximately equal to that O1A

5) With the bubble in the centre take the reading of the staff held vertically over the change point. This will be a fore sight and book this value in the level book on the next line in the column provided.

6) Now shift the level to O2 and set up it there carefully, with the bubble in the centre take reading on the staff kept vertically as the fore sight over C.P(1). This will be a back sight, book it in the same line as the fore sight already recorded in the column provided.

7) Select another CP(2) on the stable ground as before so that station O2 is approximately midway between C.P (1) and C.P(2).

8) With the bubble central, take the reading on the staff kept vertically over the CP2.This will be fore sight and book it in the level book page in next line.

9) Repeat the process until the point B.M reached .The last reading will be a foresight

method.

11) Complete the remarks column also. Apply the arithmetical check

Observation table:-

Station	Readings		Height of instrument	Reduced Levels	Remarks
A	B.S.	F.S			
B					
C					
D					
E					

RESULT: The difference of level between the point be equal to R.L of the last point minus the R.L at the B.M is found to be -----

AIM: L-Section and cross section of the road (one full size drawing sheet each for L- section and cross section)

APPARATUS: Dumpy level, leveling staff, ranging rod, tape etc.

THEORY:

Profile leveling: The process of determining elevations at points at short measured intervals along a fixed line is called Longitudinal or profile leveling.

Cross sectioning: It is a method of leveling to know the nature of Ground on either side of the centerline of the proposed route. Levels are taken at right angles to the proposed Direction of the road end at suitable distances and leveling is carried out along this cross Section.

During location and construction of highways, Rail tracks sewers and canals strakes or other marks are placed at various aligned points and the undulation of the ground surface along a predetermined line is adjoined. The line of section may be A single straight lines changing directions.

Levels are taken at right angles to the proposed Direction of the road end at suitable distances and leveling is carried out along this cross section. Cross section are the sections run at right Angles to the centerline and on the either side of it for the purpose They are taken at each 10,m station on the centerline. The length of Cross section depends upon the nature of the work if cross sections are Short they are set square out by edge. If long they are set out by the Optical square, box sextant or theodolite.

simultaneously with the longitudinal section they may be taken at the hand level, level, abney level or theodolite

PROCEDURE:

Let ABC be the line of section set out on the ground and marked with pegs driven at equal interval (say 20m to 30m) as in the figure. The level is set up generally on one side of the profile to avoid too short sight on the points near the instrument and care is taken to set up the level approximately midway between two change points. The leveling is started from the bench mark of known value. From each set up staff readings are taken on pegs already fixed at the desired interval and also at significant points where about changes of slope etc. occur. All these readings are recorded as intermediate sight against the respective chainages along the line in the level book. Other data of the level book is also filled up before starting the work. When the length of sight is beyond the power of the telescope (usually it is 100m) ,the foresight on the change point is taken. The level is then shifted and setup in an advanced position and a back sight is taken on the change point. The change point may or may not lie in the line of section. Chaining and reading are then continued as before, till the whole line of section is completed.

The work is to be checked in the progress of leveling by taking reading on other bench marks, on the way or on bench marks fixed by differential leveling.

The fore and back bearing of the section line should be taken and recorded. Next sketches of the bench mark, change points, and other feature such as nallah, a road,

column of the level-book.

The procedure and corresponding reading and values are represented on the page of a level-book for a part of road project.

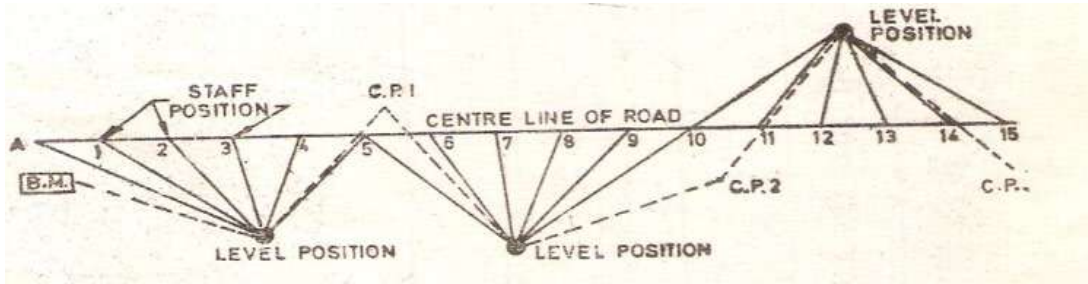

Plotting the Longitudinal section

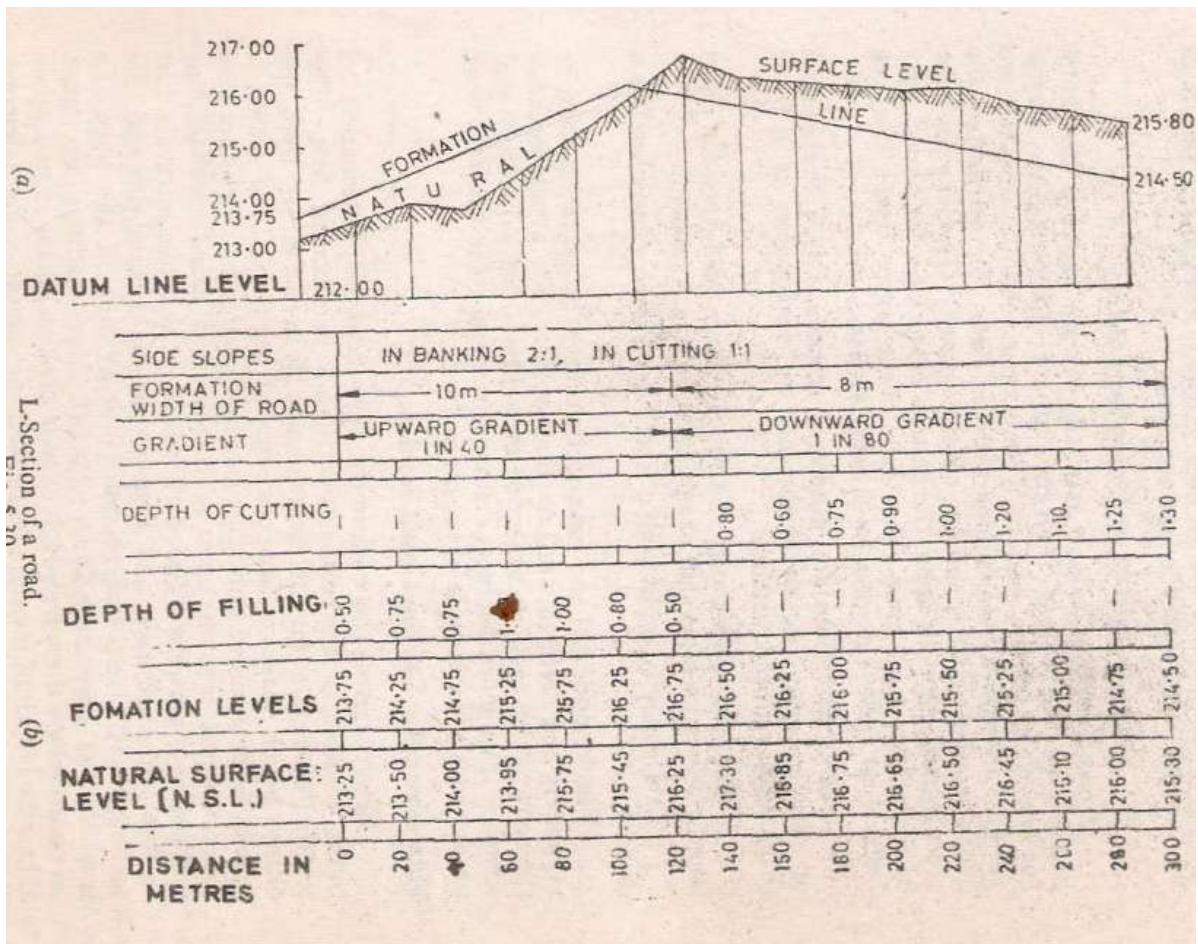

AIM : Measurement of horizontal angles theodolite by method of repetition

APPARATUS:- Theodolite , Ranging rod, pegs etc.

Figure:

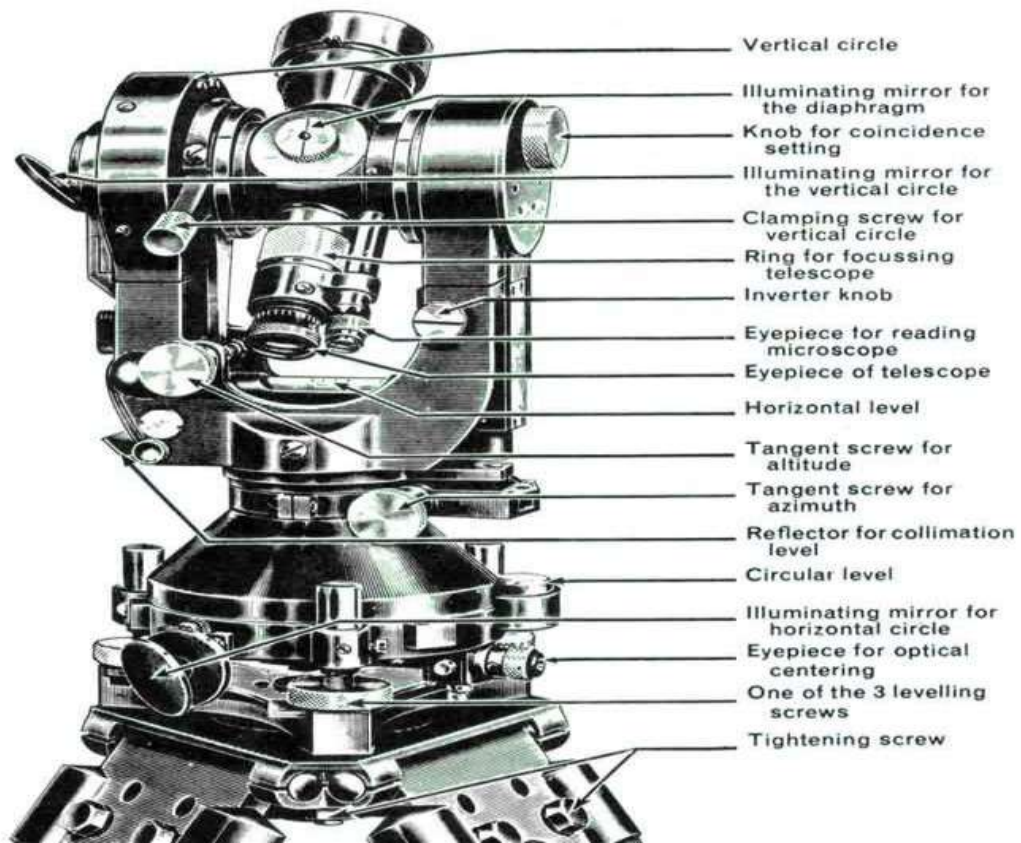

TRANSIT THEODOLITE

THEORY :

Theodolite : The theodolite is the most intricate and accurate instrument used for measurement of horizontal and vertical angles. It consists of telescope by means of which distant objects can be sighted. The telescope has two distinct motions on in the horizontal plane and the Other in the vertical plane. The former being measured on a graduated Horizontal vertical circle of two verniear.

Theodolite are primarily classified as

2) Non-transit theodolite

A theodolite is called transit theodolite when its telescope can be resolved through a complete revolution about its horizontal axis. In a vertical plane. The transit type is largely used.

Various parts of transit theodolite

- 1) Telescope: it is an integral part and is mounted on the spindle known as horizontal axis or turn on axis. Telescope is either internal or external focusing type.
- 2) The leveling head: It may consists of circular plates called as upper and lower Parallel plates. The lower parallel plate has a central aperture through which a plumb bob may be suspended. The upper parallel plate or tribranch is supported by means of four or three leveling screws by which the instrument may be leveled.
- 3) To lower plate or screw plate: It carries horizontal circle at its leveled screw. It carries a lower clamp screw and tangent screw with the help of which it can be fixed accurately in any desired position.
- 4) The upper plate or vernier plate:- it is attached to inner axis and carries two vernier and at two extremities diametrically opposite.
- 5) Compass: the compass box may be either of circular form or of a rough type. The former is mounted on the vernier plate between the standards while the latter is attached to the underside of the scale or lower plate or screwed to one of the standards. Modern theodolite is fitted with a compass of the tubular type and it is screwed to one of the standards.
- 6) Vertical circle: the vertical circle is rigidly attached to the telescope and moves with it. It is silvered and it is usually divided into four quadrants.

the telescope in front of the vertical axis. It carries two vernier of the extremities of its horizontal arms or limbs called the index arm. The vertical leg called the clip or clipping screws at its lower extremity. The index arm and the clipping arm are together known as T-frame.

- 8) Plumb bob: To centre the instrument exactly over a station mark, a plumb bob is suspended from the hook fitted to the bottom of the central vertical axis.

Repetition method of measuring Horizontal angles

When it is required to measure horizontal angles with great accuracy as in the case of traverse, the method of repetition may be adopted. In this method the same angle is added several times by keeping the vernier to remain clamped each time at the end of each measurement instead of setting it back to zero when sighting at the previous station. The corrected horizontal angle is then obtained by dividing the final reading by the number of repetitions. Usually six reading, three with face left and three with face right, are taken The average horizontal angle is then calculated.

Procedure:-

- 1) Let LOM is the horizontal angle to be measured as shown in fig. O is the station point fixed on the ground by a peg. Set up the theodolite over the peg 'o' and level it accurately.
- 2) Set the horizontal graduated circle vernier A to read zero or 360° by upper clamp screw and slow motion screw. Clamp the telescope to bisect the bottom shoe of the flag fixed at point 'L' and tighten the lower clamp. Exactly intersect the centre of the

theodolite should be left and the telescope in normal position.

- 3) Check the reading of the vernier A to see that no slip has occurred .Also see that the plate levels are in the centre of their run. Read the vernier B also.
- 4) Release the upper clamp screw and turn the theodolite clockwise. Bisect the flag bottom shoe fixed at point M by a telescope. Tighten the upper clamp screw and bisect the shoe exactly by means of upper slow motion screw.
- 5) Note the reading on both the vernier to get the approximate value of the angle LOM.
- 6) Release the lower clamp screw and rotate the theodolite anticlockwise at azimuth. Bisect again the bottom shoe of the flag at 'L' and tighten the lower clamp screw. By means of slow motion screw bisect exactly the centre of the shoe.
- 7) Release now the upper clamp screw and rotate the theodolite clockwise. Bisect the bottom shoe of the flag fixed at M and tighten the upper clamp screw. By means of slow motion screw bisect exactly the centre of the shoe. The vernier readings will be now twice the of the angles.
- 8) Repeat the process until the angle is repeated the required number of times (usually 3). Add 360° for every complete revaluation to the final reading and divided the total angle by number of repetitions to get the value of angle LOM.
- 9) Change the face of the theodolite the telescope will now be inverted. Repeat the whole process exactly in the above manner and obtain value of angle LOM.
- 10)The average horizontal angle is then obtained by taking the average of the two angles obtained with face left and face right.
- 11)Usually three repetitions face left and three with face right should be taken and the mean angle should be calculated.

S.N.	Instrument Station	Shifted to	Face left readings			
			Venier A 0,I,II	Venier B 0,I,II	Total angle	No of Repetition
	o	L				
		M				
		L				
		M				
		L				
		M				

S.N.	Instrument Station	Shifted to	Face Right readings				
			Venier A 0,I,II	Venier B 0,I,II	Total angle 0,I,II	No of Repatition	Mean horizontal angle 0,I,II
	o	L			3		
		M					
		L					
		M					
		L					
		M					

RESULT: Average horizontal angle is found to be -----

AIM: Measurement of vertical Angles with Theodolite

APPARATUS:- Theodolite, three ranging rods,

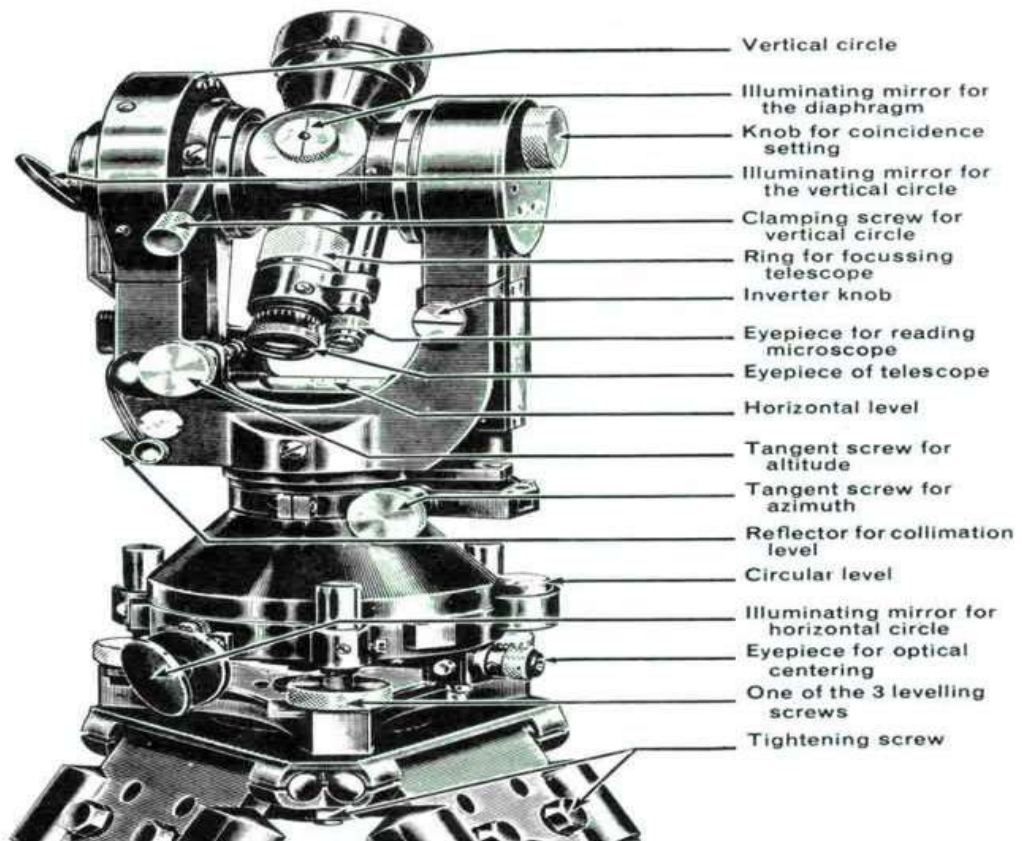

THEORY: Theodolite is an instrument designed for the measurement of horizontal and vertical angle. It is most precise method it is also used for laying of horizontal angles. Locating points on line prolonging the survey line establishing the gradient, determination of difference in the elevation setting out curve. Theodolite are of two types transit and non transit. Transit theodolite is commonly used now a days. In transit theodolite telescope can be revolved a complete revolution about its horizontal axis in a vertical plane. A transit theodolite consists of essential part.

tripod. The head comprises of two parts

a) A leveling foot screws for leveling the instrument i.e. for marking vertical axis truly vertical.

b) A movable head or centering arrangement for centering the vertical axis accurately over a station point.

2) **A lower level circular horizontal metal plate:** It carries a circular graduated arc . The lower plate is attached to a vertical metal spindle (outer axis) which works in vertical bearing and a form a part of leveling head. It may be graduated in degree and half degree or a degree $\frac{1}{3}$ of degrees .the upper plate carries an index and vernier or micrometer towards fine reading on gradated horizontal circle .the upper plate carries standard use of for supporting the telescope and the spirit level used for leveling the instrument.

3) **A telescope:** The telescope is pivoted between the standard at right angles to the horizontal axis . It can be rotated about its horizontal axis in a vertical plane. The telescope is provided with the focusing screw, Clamping screw and tangent screw.

4) **A circular graduated are carried on vertical circle:** It is attached to the horizontal axis of the telescope, it is usually divided into 4 quadrants, but in some instruments it is graduated continuously from $0-360^{\circ}$.the graduation in each quadrant are numbered from $0-90^{\circ}$ in opposite direction. The subdivisions of vertical circle are similar to those of vertical circle.

MESURMENT OF VERTICAL ANGLE

A vertical angle is the angle between the inclined line of sight to an object and the horizontal. It may be an angle of elevation or on angle of depression according as the

instrument. To measure angle of elevation or depression LOM shown in fig. proceed as follows:

- 1) Set up the theodolite at station point O and level it accurately with reference to the altitude level.
- 2) Set vertical verniers C and D exactly to zero by using the vertical circle clamp and tangent screw, while the altitude level should remain in the centre of its run. Also the face of the theodolite should be left.
- 3) Release the vertical circle clamp screw and rotate the telescope in vertical plane so as to bisect the object M. tighten the vertical circle clamp and exactly bisect the object by slow motion screw.
- 4) Read both verniers C and D. the mean of the two readings gives the value of the required angle.
- 5) Similar observation may be made with other face. The average of the two values thus obtained gives the value of the required angle which is free from instrumental errors.
- 6) Similarly the angle of depression can be measured following the above steps.

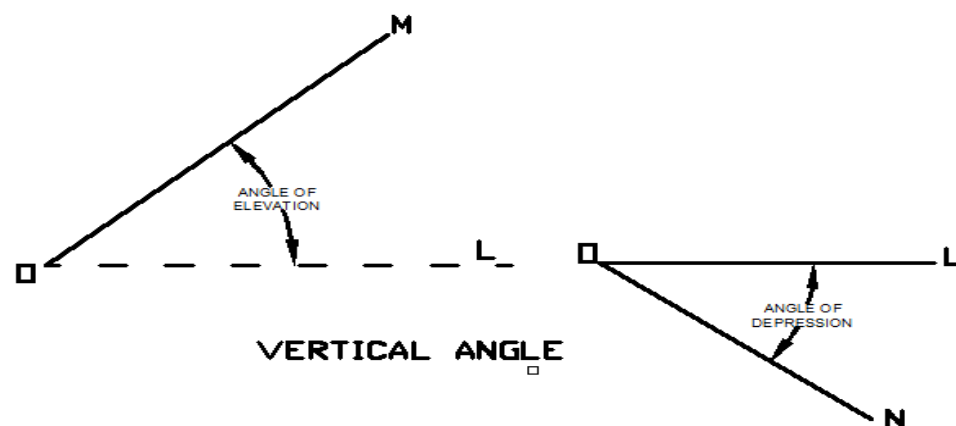

To measure the vertical angle between two points L and M

Some times it is required to measure vertical angle between two points L and M . There can be three possibilities.

(a) One point is above the line of sight and the other is below the line of sight then angle LOM as shown in fig will be equal to $(\alpha + \beta)$

(b) Both the points are above the line of sight. Then the angle $LOM = \alpha - \beta$

(Refer Fig 2)

(c) Both the points are below the line of sight, then the angle $LOM = \alpha - \beta$ (Refer Fig 3)

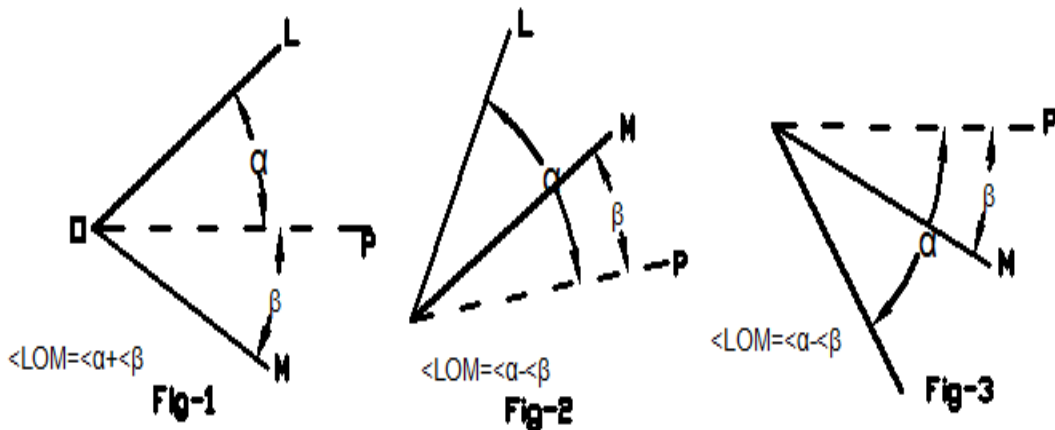

To measure the angle between two points L and M proceed as follows

- 1) Set the theodolite at station point O and accurately level it.
- 2) Bisect the flag at L as explained already and take the reading on the verniers C and D. Calculate the mean angle.
- 3) Bisect the flag at M as before and take the reading on the verniers C and D. Calculate the mean angle.

between points L and M as shown in the figure (4)

Observation table:-

S.N.	Instrument Station	Sighted to	Face left readings			Vertical Angle
			Venier C 0,I,II	Venier D 0,I,II	Mean Angle	
	o	P				
	(+ve)	L				
	(-ve)	M				

S.N.	Instrument Station	Sighted to	Face Right readings			Vertical Angle 0,I,II	Average Vertical Angle 0,I,II	Remarks
			Venier C 0,I,II	Venier D 0,I,II	Mean Angle 0,I,II			
	o	P						
	(+ve)	L						
	(-ve)	M						

Result: The average value of vertical is found to be-----.

AIM: Determination of horizontal distance between two inaccessible points with theodolite

APPARATUS:- Theodolite, three ranging rods

Theory: - Traverse computation

The latitude of the line may defined as the distance measured parallel to an assumed meridian direction (i.e true meridian, magnetic meridian or any other reference direction).

The departure of a line may defined as the distance measured parallel to line perpendicular to the meridian.

The latitude (L) of a line is positive (+ve) when measured northward or upward and is termed as Northing, the latitude of a line (-ve) when measured southward or downward and termed as southing

Similarly the departure (D) of a line is positive (+ve) when measured Eastward or to the right and is known as Easting. The departure of a line is negative (-ve) when measured Westward or to left

Westing

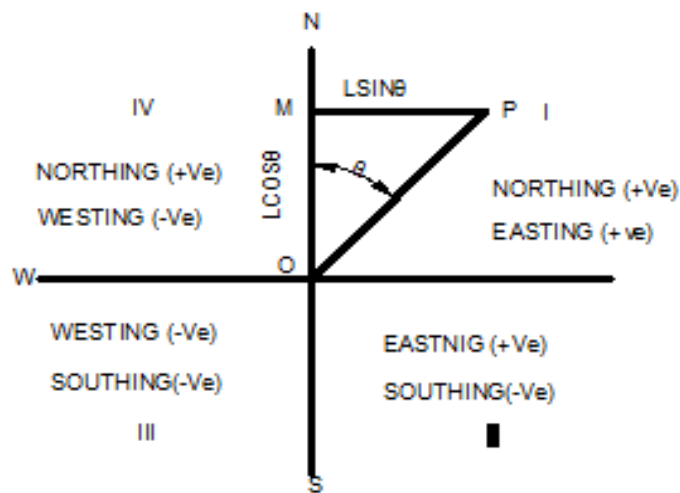

Refer to fig suppose the length of the line $OP=L$ and bearing of the line θ , then

Departure of the line = $l \sin \theta$

Thus to find the latitude and departure of the line, it is essential to convert the bearing (W.C.B) to reduced bearing (R.B); because the sign of latitude and departure depends upon the reduced bearing i.e the first letter N or S determine the sign of the latitude and E or W determine the sign of the departure.

The following table gives the sign of latitude and departure.

S.N.	Whole Circle Bearings (W.C.B)	Reduced Bearing	Sign of		Quadrant
			Latitude	Departure	
1	0° to 90°	NØE	+	-	I
2	90° to 180°	SØE	-	+	II
3	180° to 270°	SØW	-	-	III
4	270° to 360°	NØW	+	-	IV

Problem: - the distance between two inaccessible points P and Q, the theodolite is set up at two stations A & B 1000m apart and the following angles were observed.;

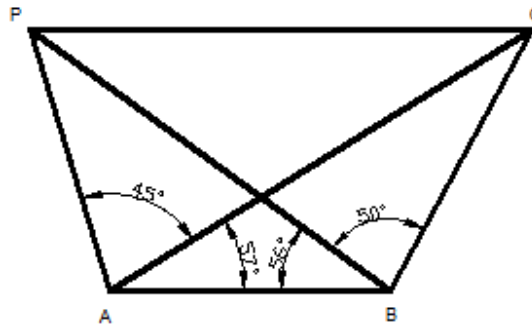

$\angle PAQ = 45^\circ$; $\angle PBQ = 50^\circ$; $\angle PAB = 57^\circ$; $\angle PBA = 42^\circ$, The distance of two inaccessible point PQ is calculated by

It is clear that lines PA, AB, BQ, and QP form a closed traverse. The latitude and departure of lines PA, AB and BQ can be determined by calculating their length and bearing first.

$$\angle ABP = 56^\circ$$

$$\angle BPA = 180^\circ - (102^\circ + 56^\circ) = 22^\circ$$

Hence, from sine rule

$$\frac{PA}{\sin PBA} = \frac{AB}{\sin BPA}$$

$$PA = \frac{1000 \times \sin 56^\circ}{\sin 22^\circ} = 2213m$$

Similarly, $\triangle QAB$

$$\angle QAB = 57^\circ$$

$$\angle QBA = 106^\circ$$

$$\angle AQB = 180^\circ - (57^\circ + 106^\circ) = 17^\circ$$

Now ,

$$\frac{BQ}{\sin 57^\circ} = \frac{AB}{\sin 17^\circ}$$

$$BQ = \frac{1000 \times \sin 57^\circ}{\sin 17^\circ} = 2869m$$

Hence .the bearing of various sides are not given by assuming any line (say, line PA) as the reference meridian, the bearing of other lines can be calculated by the given angles as follows:

Bearing of the line	=0°
Add	= 180°
Bearing of line AP	= 180°
Add $\angle PAB$	=102°
Bearing of the line AB	=282°
Deduct	=180°
Bearing of line BA	=102°
Add $\angle QBA$	=106°
Bearing of line BQ	=208°
R.B. of line PA= N 0° E	

R.B. of line BQ = S28° W

The latitudes and departure (or consecutive coordinates) can be calculated as given below;

S.No.	Line	Length (m)	R.B.	Latitude L	Departure D
1	PA	2213	N 0° E	+2213.0	+0.0
2	AB	1000	N 78° W	+207.9	-978.1
3	BQ	2869	S28° W	-2531.0	-2325.1
			Total	-110.1	-2325.1

$$\text{Result: - Length of line PQ} = \sqrt{(\sum L)^2 + (\sum D)^2} = \sqrt{(-110.1)^2 + (2325.1)^2}$$
$$= 2328\text{m}$$

AIM: Locating given building by theodolite traversing (One full size drawing sheet)**APPARATUS:-** Theodolite, three ranging rods**THEORY: Theodolite Traversing:**

A traverse survey is one in which the framework consists of a series of connected lines, the lengths and direction of which are measured with the help of tape or chain and an angle measuring instrument.

When the lines form a circuit which ends at the starting point, the survey is termed a closed traverse, if the circuit does not close, the traverse is known as an open one.

The closed traverse is suitable for wide areas and for locating the boundaries of the lakes, woods etc., where an open traverse is carried out in the case of long strips of country as in the case of canal, road, railway etc.

In theodolite traversing, theodolite is used for measurement of angles or tape or chain, preferable, steel tape is used for linear measurement. This method is applied for accurate and precise survey.

Method of traversing

The method of measuring the angle and bearing of a traverse may be divided into classes:

- a) Those in which the angle at different stations are measured directly and the bearing subsequently calculated from the measured angles and the given bearing of an initial line
- b) By direct observation of bearing of different survey lines by a theodolite.

A) **theodolite Traversing by Direct Observation of Angle:-** In this method, horizontal angles measured at different stations may be either,

ii. Deflection Angle

1) **Traversing by the method of included angles:-**

In a closed traverse included angles can be measured by running a traverse in clockwise or counterclockwise direction. The common practice is to run a closed traverse in counterclockwise direction, but it is well to adhere to a regular or routine of measuring angles. Generally interior angles are obtained if the traverse is run anticlockwise and exterior ones when it is run clockwise as shown in the fig 1 & 2.

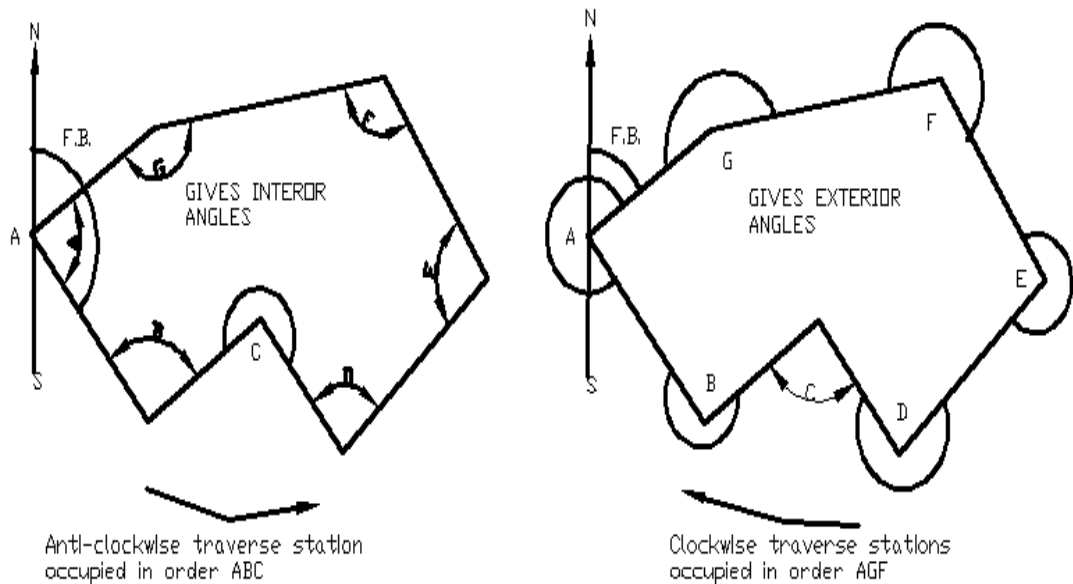

The angle may be measured by the repetition method and the observation should be taken with both the faces and also by reading both the verniers. Then averaging the value of each angle should be calculated. It will ensure desired degree of accuracy and removal of most of the instrumental errors.

Procedure: - In running a traverse ABCDEFG as shown in figure, set up the theodolite over the station A and level it accurately. Observe the magnetic bearing at the line AB and measure the included angle GAB as usual. Shift the theodolite to each of the successive stations B, C, D, E----(in anticlockwise direction) and repeat the process to measure each of the angle ABC, BCD, CDE etc. Also measure the length of the line AB, BC, CD and so on by means of a steel tape if possible and take necessary offsets to locate different details on each of the survey line. The whole work should be recorded carefully in the field note book.

In open traverse say LMOP as shown in Fig. the theodolite is setup at starting station L and fore bearing of line LM is taken. The theodolite is then shifted M, O and the direct angles such as LMO, MOP---- are measured in the forward direction. Length of each line is measured and necessary offsets are taken to locate different details on each of the survey line.

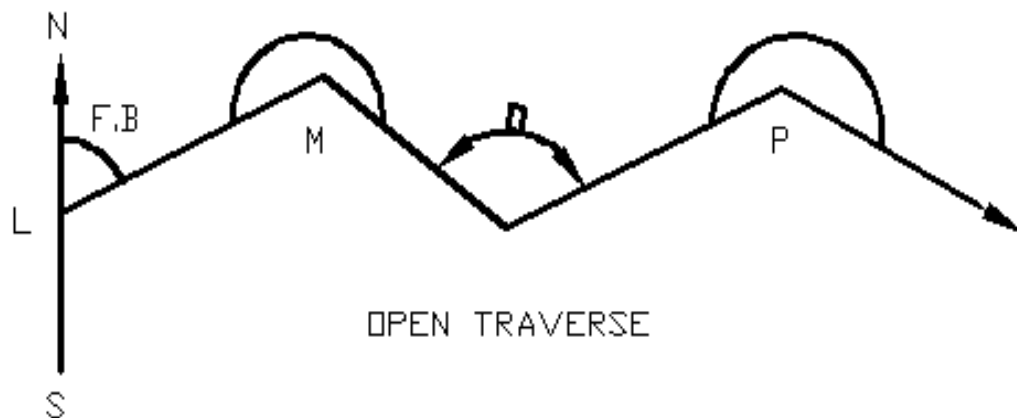

This method of traversing is more suitable in surveys for railway, roads, pipeline etc. in which a series of traverse lines may make small deflection angles with each other.

In measuring deflection angles having observed the bearing at the starting station 'L' Set the theodolite at each of station such as M,N,O,Q. Bisect the back stations using lower clamp and its tangent screw. The vernier may be set to zero or the initial reading may be taken. The theodolite is transited and the forward station is bisected with upper clamp screw and the tangent screw. The verniers are again read, the difference between the first set of reading and the second gives the angle of deflection. The measurement is either right or left handed and this direction must be most carefully noted in the field book. Chaining is done in the usual manner.

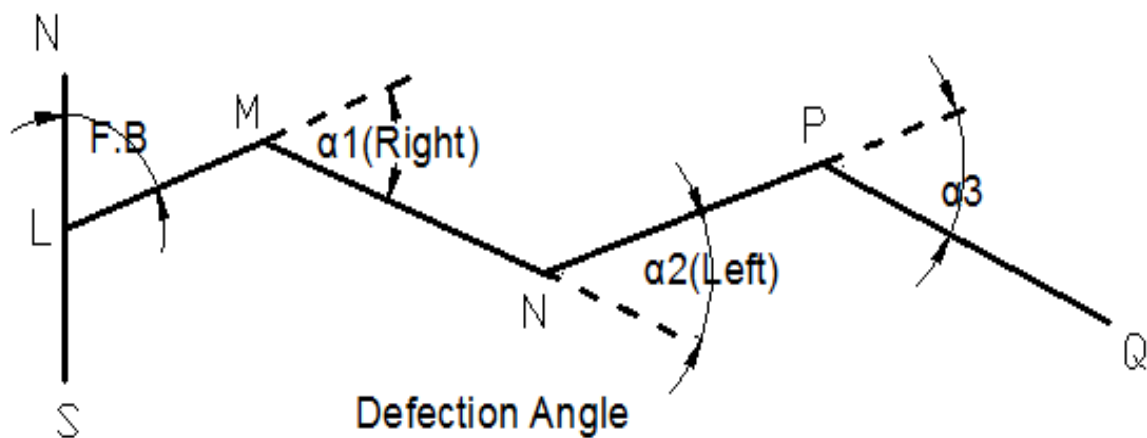

Traverse computation are usually are done in the tabular from the most commonly used tabular from is known as Gale's traverse table.

The steps followed are as under for computing the table.

- 1) Find out the sum of all the observed, interior or exterior angle it should be $(2n+4)$ right angle where n = number of sides of traverse.
- 2) If the sum is not equal to $(2n+4)$ right angles for exterior or interior angles apply the necessary correction to all the angle so that the sum of the corrected angles should be exactly equal to $(2n\pm 4)$ right angles.
- 3) Find out the whole circle bearing (W.C.B) of all other lines from the observed bearing of the first line and the corrected included angles.

As a check the calculated bearing of the first line must be equal to observed bearing.

- 4) Convert the whole circle bearing to the reduced bearings and determine the quadrant in which they lie.
- 5) Calculate the latitude and departure of each line from the known length and the reduced bearing of the lines.
- 6) Find out the sum of all northings and also of southings similarly of eastings and westings. Determine the difference if any between northings and southings, also in eastings and westings.
- 7) Apply the necessary correction as per calculations to the latitudes and departures of each lines, so that the sum of northings must be equal to sum of southings, also eastings and westings

AIM: Locating given building by plane table surveying (One full size drawing sheet) .

APPARATUS: 1) The Plane table with tripod,2) Alidade,3) Trough compass 4) Sprit level ,5) Plumbing fork or U-frame,6)Plumb bob,7) Tape ,chain,pegs,ranging rods,wooden mallet etc.

THEORY:

Plane table surveying: the system of surveying in which field observation and plotting work i.e. both are done simultaneously is called plane table surveying.

The plane Table:- The drawing board made of well seasoned wood such as teak or pine which is used for the purpose of plotting is called plane table.It is available in sizes 500x400x15mm,600x500x15mm and 750x600x20mm.The top surface of board is perfectly plane and to the underneath it is fitted with a leveling head or ball and socket arrangement. The table is mounted on a tripod by means of a central screw with a wing nut or in such a manner so that the board can be revolved, leveled and clamped in any position.

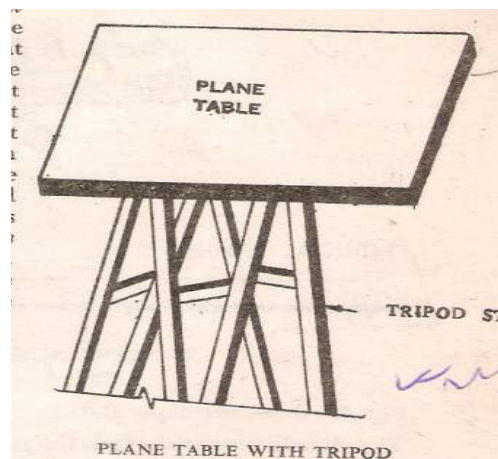

seasoned) rule 40cm to 60cm long, 3cm to 5cm wide and fitted with two vanes at the ends is called an alidade.

The beveled graduated edge is known as the fiducial edge. Such an alidade is known as plain alidade.

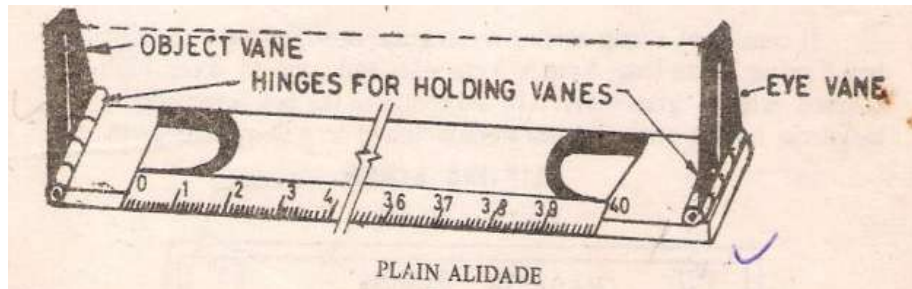

Trough Compass:

The compass which is used to mark the direction of the magnetic meridian on the plane table is called trough compass. It consists of a long narrow rectangular non-magnetic metallic box 8cm to 15cm long, 3cm to 5cm wide and 2cm to 3cm high on the top covered with a glass cover. In the centre of the box is provided a magnetic needle with a agate stone mounted on the sharp steel pivot. At the end of the trough compass graduated scales are with zero degree at the centre and up to 5° on either side of the zero line. A counter weight is also used for North end of the needle to represent North and is also used for balancing the dip of the needle.

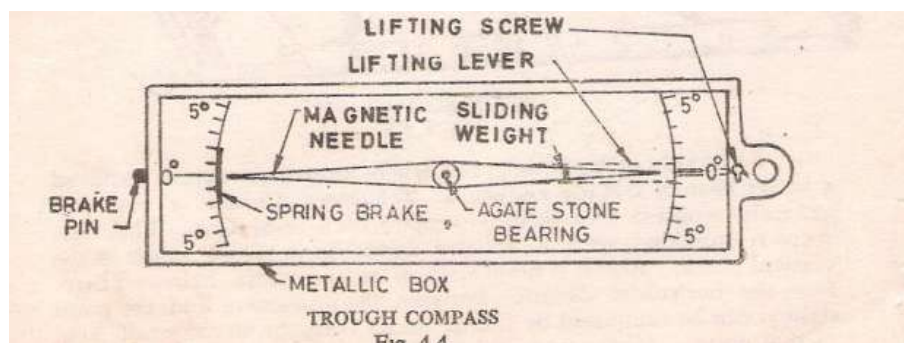

Sprit Level:- A small sprit level circular or rectangular is required for seeing if the table is properly level. The level must have flat base so that it can be placed on the table.

Plumbing fork or U-frame :- The plumbing fork to which is attached a plumb bob ,used for centering the plane table over the station occupied by the plane table. it is also meant for transforming the ground point on to sheet so that both the points should be in the same vertical line

It consists of two light metal arms as shown in fig. approximately of equal lengths. A hook for suspending a plumb bob is provided at the lower arm immediately below the end point of the upper arm. The upper arm is placed on the plane table while the lower arm with a plumb bob is moved below the table for centering over the ground station mark,thus in the exact position the pointed end of the upper arm will give the corresponding position on the paper.

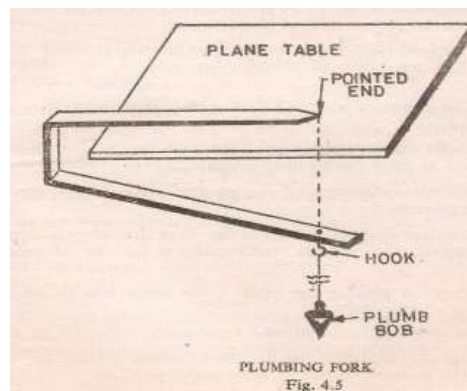

details are located on the sheet, the method is known as radiation method

In this method the rays are drawn from the instrument station to the point to be located, then the distances are measured from the instruments station to the point and the position of the each point is plotted on the sheet using a suitable scale.

The method is most suited for surveying small areas which can be controlled by single setting. It can also be used in combination with other method. This method can be applied for locating distant points if the distances are obtained tacheometrically with the help of the telescope alidade.

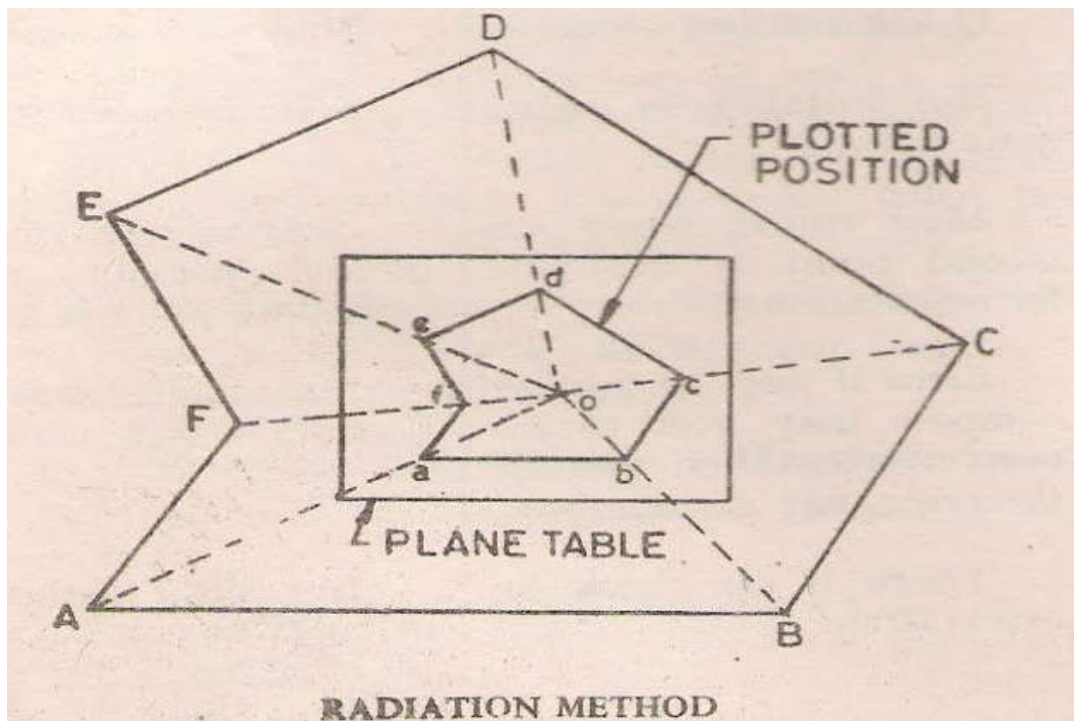

Procedure:- 1) Select the position of the table where it is to be set so that all the points to be located are visible from it. Let 'O' be the position of such a point on the ground.

of sheet by means of trough compass at the table.

- 3) Now transfer the position of the point 'O' on the ground to the sheet by means of the a plumbing fork. The point 'O' will represent point 'o' will represent point 'O' on the ground.
- 4) With the alidade touching the point 'o' (may be represented by fixing a pin), sight the point A in the field. Draw the ray along the fiducial edge. Measure the distance of this point from the instrument station by means of tape and plot the point 'a' corresponding to point 'A' in the field to scale in the sheet.
- 5) Similarly sight other points such as B,C,D,E etc. and measure their distances from the instrument station. Plot them to scale to get their position on the sheet such as b,c,d etc. on the sheet.

Intersection method:-

When the location of an object is obtained on the sheet of paper by the intersection of the rays drawn after sighting at the object from two plane table stations (previously plotted), it is called intersection method.

The method is suitable when the distance between the point and the instrument station is either too large or cannot be measured accurately due to some field conditions as in case of mountainous country. It is also employed for filling up details, locating distant and inaccessible object, locating the broken boundaries as in the case of rivers etc. The method can also be used for checking of plotted points.

The line joining the two instrument stations is known as the base line. No linear measurement other than the base line is made.

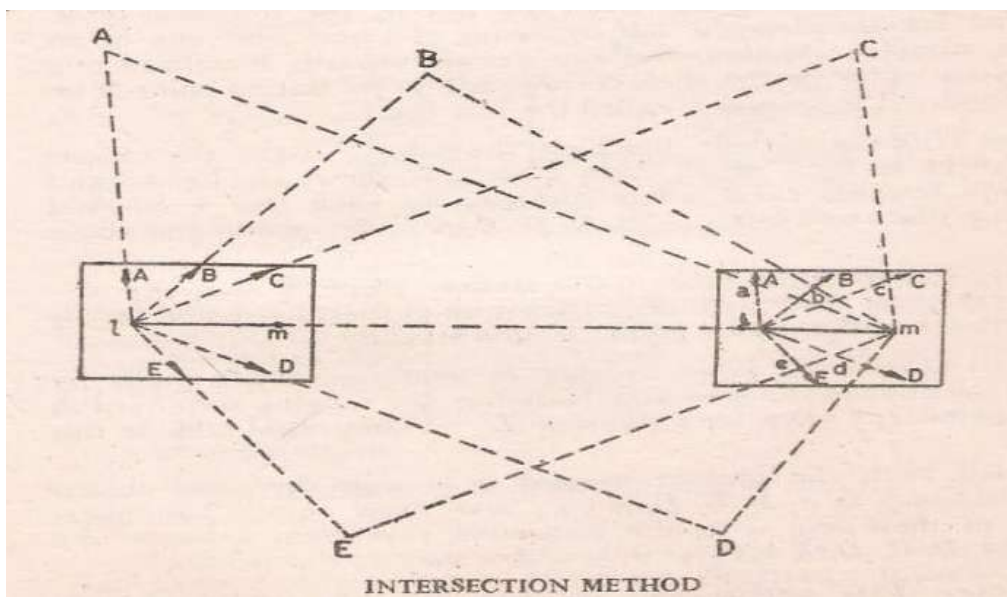

Procedure :-

- 1) Select two points L and M in such a way so that all the points to be plotted are visible from them. Now set the table at station, point L in such a position so that the sheet should cover all the points. Level the table and clamp it.
- 2) Draw the north line in the top corner of sheet by means of trough compass
- 3) Now transfer the position of station point L on the sheet as 'l' with the help of plumbing fork so that it is vertically above the instrument station.
- 4) With the alidade pivoted about 'l' sight the ranging rod fixed at station point M and draw the line in the direction of M. Now measure the distance LM by means of the tape and cut off lm to some suitable scale along the ray drawn toward M; thus fixing the position of 'm' on the sheet corresponding to station point M on the ground. The line lm is called the base line.
- 5) With the alidade touching the point 'l' sight the objects in the field such as A,B,C,D,E etc. as shown in figure and draw the rays towards them. The

corresponding to above details.

- 6) Now shift the table to the station point M and approximately set it in the line with ML. Set it up so that the point 'm' is vertically above the station point 'M' and level it.
- 7) Orient the table roughly by compass, then finally by placing the alidade along ml and bisecting the ranging rod fixed at station point 'L' i.e by back sighting 'L'. Clamp the table in this position.
- 8) With the alidade centered at m sight the same object in the field such as A, B, C, D, E etc; and draw rays. The intersection of these rays with the respective rays from l locate the object A,B,C,D,E etc; as a ,b,c,d,e etc; on the sheet.

AIM : Three point problem in plane table surveying.

APPARATUS : Plane table alidade, plumbing fork, plumb bob, Ranging rod, drawing sheet etc.

THEORY : It is finding the location of the station occupied by a plane table on the sheet, by means of sighting to three well-defined points of known location on the sheet. The principle of this method lies in the fact that if the plane table is correctly oriented, the three resectors through a , b , & c , shown in fig. meet at a point p which is the location of the plane-table station on the sheet, provided the points A, B, C & P do not lie on the circumference of a circle. By solving three-point problem, thus, the orientation & resection are accomplished simultaneously.

The solution of three-point problem is further illustrated graphically in fig. the stations A, B , & C are of known position & p is of unknown position. If the angle a is observed between PB , & PA , the position of P is indeterminate, because P can be anywhere on the circle circumscribing the triangle PAB . Additional information is needed to make the problem determinate. If the angle B , which is the angle subtended by AC at P , is also observed then the solution is unique since P, A & C lie on the circle that circumscribe triangle PAC , & P is one of the two intersection points of the circles & A is the other intersection point. This solution becomes indeterminate if A, B, C , & P fall on the circumference of one circle.

If the two circles tend to merge into one circle, the problem will be less stable & finally becomes indeterminate again when the two circles coincide. Points should be selected in the field so as to avoid this situation.

methods applicable to the plane table discussed.

- a. mechanical method (tracing paper method)
- b. graphical method
- c. trial & error method (Lehmann's method)

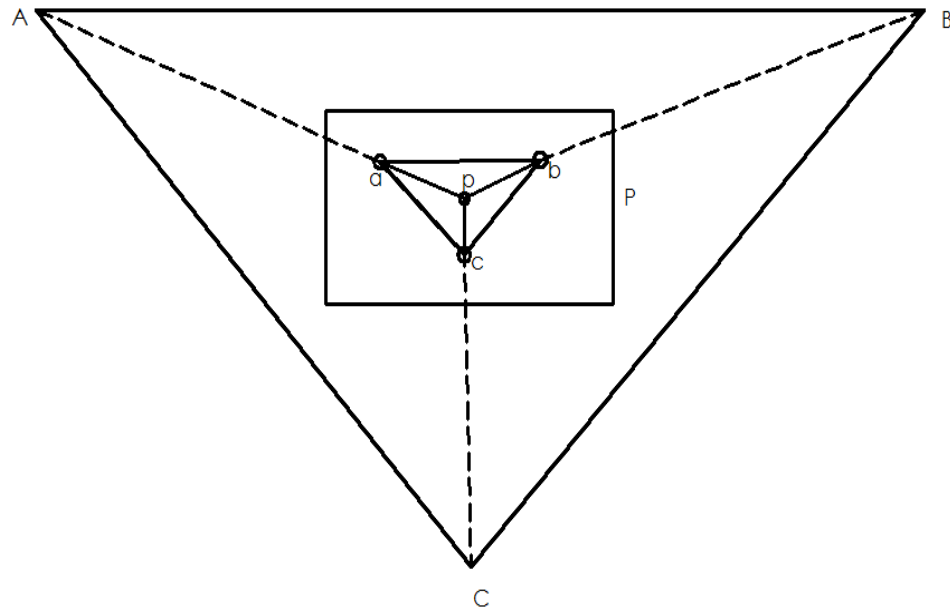

PROCEDURE:-

The three point problem consists in locating on the plan the position of the instrument station on the ground by means of observation to three well defined points whose positions have been already plotted on the plan. Suppose A, B, & C are the three points which have been plotted as a, b, & c on the plan & the table is set up at T from which A, B, & C are visible. It is required to plot on the plan the position t of the instrument station T.

The problem may be solved by (1) Mechanically (2) Graphically (Bessel's method) & (3) by trial & error method

- i. After setting & leveling the table, the alidade is placed along the line ca & the board turned until A is sighted being towards A . the table is then clamped. With the alidade centered on C , B is sighted & a ray CB is drawn along the edge of the alidade.
- ii. When the alidade placed along ac , the board is turned until the line of sight bisects c , c being towards C & then clamped. With the alidade touching a , B is sighted & a ray aB is drawn through a ; intersecting the ray previously drawn through in the point d .
- iii. With the alidade along bd , the table is turned until B is bisected & then clamped. The table is now oriented & t must lie on db & also on Aa & Cc . with the alidade centered on a , A is bisected & a ray is drawn through a , intersecting the ray bd in t , which represent the instrument station T .

To check the orientation, the alidade is pivoted on c & C is bisected. The ray Cc should now pass through t , if the work is correct.

RESULT: The location of the station on given point is found on sheet.

AIM:- Determination of elevation of point by trigonometric levelling.

Theory:- Trigonometrical leveling is the process of determining the difference of elevation of station from observed vertical angles and known distances, which are assumed to be either horizontal or geodetic length at mean sea level. The vertical angles may be measured by means of an accurate theodolite and the horizontal distances may either be measured (in case of plane surveying) or computed (in case of geodetic observation)

Base of the object accessible:-

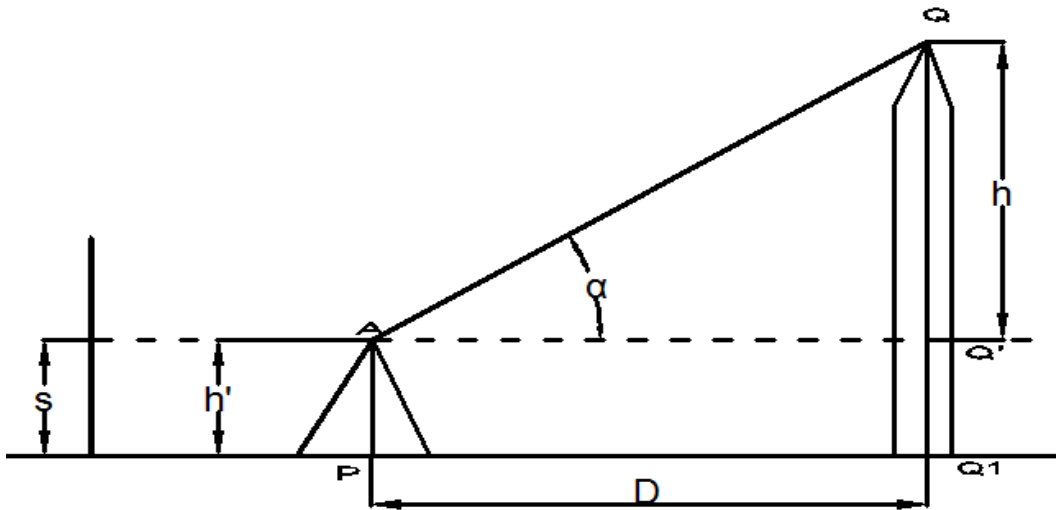

Height and Distances

1) Base of the object accessible:- The horizontal distance between the instrument and the object can be measured accurately.

Let P= instrument station.

Q=Point to be observed

A=centre of the instrument

$D = AQ' =$ horizontal distance between P&Q

$h' =$ height of the instrument at P

$h = QQ'$

$S =$ Reading on staff kept at B.M, With line of sight horizontal. $\alpha =$ angle of elevation from A to Q to Q

From triangle AQQ' , $h = Dt \tan \alpha$

R.L of Q = R.L of instrument axis + $D \tan \alpha$

If the R.L. of P is known,

R.L. of Q = R.L of P + $h' + D \tan \alpha$

If the reading on the staff kept at the B.M. is S with the line of sight horizontal.

R.L of Q = R.L. of B.M + $S + D \tan \alpha$

2) Base of the object inaccessible: - if the horizontal distance between the instrument and the object can be measured due to obstracles etc., two stations are used so that they are in the same vertical plane as the elevated object.

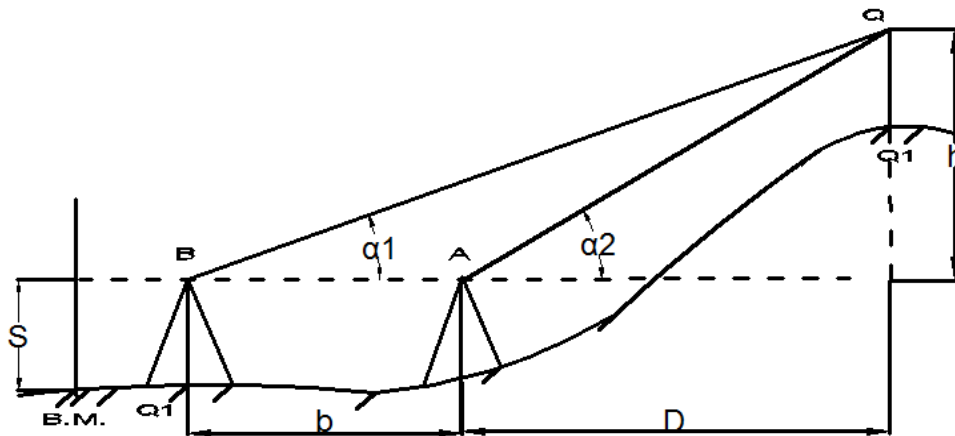

a) Instrument axes at the same level:-

Let $h=QQ'$, α_1 = angle of elevation from A to Q, α_2 =angle of elevation from B to Q

S = staff reading on B.M taken from both A and B, the reading being the same in the both the cases.
 b =horizontal distance between the instrument stations,

D = horizontal distance between P&Q

From triangle AQQ' , $h=D \tan \alpha_1$ ------(1)

From triangle BQQ' , $h=(b+D) \tan \alpha_2$ -----(2)

Equating (1) and (2), we get,

$$D \tan \alpha_1 = (b+D) \tan \alpha_2$$

$$D(\tan \alpha_1 - \tan \alpha_2) = b \tan \alpha_2$$

$$D = \frac{b \tan \alpha_2}{\tan \alpha_1 - \tan \alpha_2}$$

$$h = D \tan \alpha_2$$

$$= \frac{b \tan \alpha_1 \tan \alpha_2}{\tan \alpha_1 - \tan \alpha_2}$$

$$= \frac{b \sin \alpha_1 \sin \alpha_2}{\sin(\alpha_1 - \alpha_2)}$$

$$\text{R.L. of Q} = \text{R.L. of B.M.} + S + h$$

Procedure:-

- 1) Set up the theodolite at P and level it accurately with respect to the altitude bubble.
- 2) Direct the telescope toward Q and bisect it accurately. Clamp both the planes.
Read the vertical angle α_1 .

station R on the ground. Measured the distance RP accurately. Repeat steps (2) and (3) for both face observation. The mean values should be adopted.

- 4) With the vertical vernier set to zero reading, and the altitude bubble in the centre of the run, take the reading on the staff kept at nearby B.M.
- 5) Shift the instrument to R and set up the theodolite there. Measured the vertical angle α_2 to Q with both face observations.
- 6) With the vertical vernier set to zero reading, and the altitude bubble in the centre of the run, take the reading on the staff kept at the near by B.M.

Observation table:-

Instrument Station	R.L @ B.M	Reading on staff kept at B.M.	Vertical angle (a)	Horizontal distance between instrument station and object	R.L of the object

Result:- the elevation of the object from the B.M is found to be-----m

AIM : Counter plan of given area (Oe full size drawing sheet)

APPARATUS: Dumpy level, prismatic compass, chain 20m, 30m, metallic
Tape, ranging rod Leveling staff, pegs line.

THEORY:

CONTOURING: The elevation and depression the undulations of the surface of the ground are shown as map by intersection of level surface with by means of contour line. a contour may be defined as the line of intersection of a level surface with the surface of the ground.

Characteristics of Counter Lines

The following are the Characteristics of the contours/ contour lines.

- 1) All points on the same contour line will have the same elevation.
- 2) Contour lines close together represent steep ground, while uniform slope is indicated when they are uniformly spaced. A series of straight, parallel and equally spaced contours show a plane or flat surface.
- 3) Contour lines of different elevation cannot merge or cross one another on the map, except in the case of an overhanging cliff. A vertical cliff is indicated when several contours coincide [see fig 1.1 (a) and (b)]

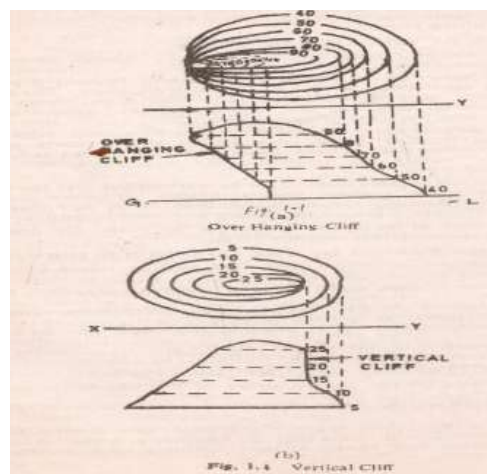

- 5) Series of closed contour lines on the map either represent a hill or a depression according as the higher or lower values are inside them as shown in figs [1.2(a) and (b)

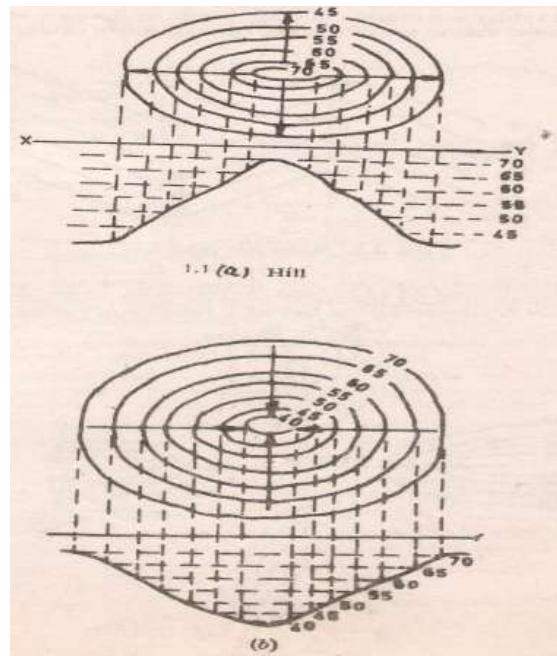

- 6) A contour will not stop in the middle of the plan. It will either close or go out of the plan.
- 7) Ridge or water shed and valley lines are the lines joining the top most or the bottom most points of hill and valley respectively, cross the contours at right angles. A ridge line is shown when the higher values are inside the loop, while in the case of a valley line, the lower values are inside the loop as shown in fig (1.3)

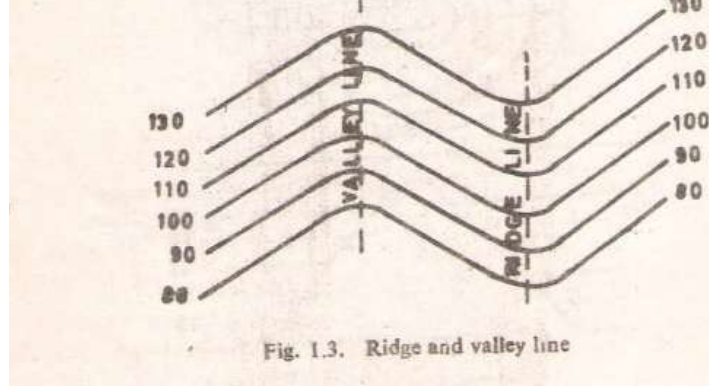

8) Contour lines are not drawn across the water in the stream or river because the water level in the it is not constant; but contours are drawn along the bed of a river or a stream.

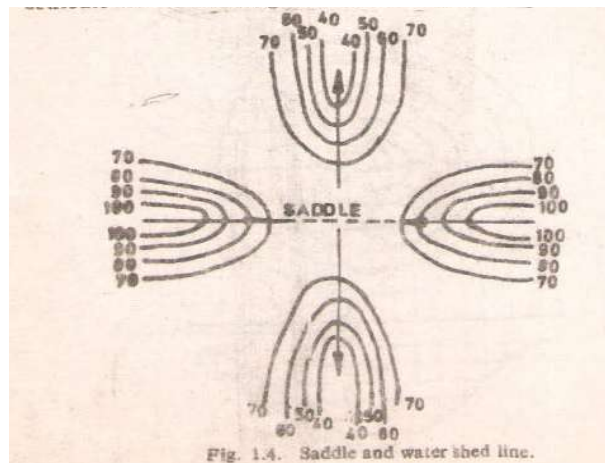

Uses of contour map

- 1) For preparing contour map in order to select the most economical or a suitable site.
- 2) For getting the importance about ground whether it is undulating or mountainous

construction will be economical and will command maximum irrigated area.

4) To make the alignment for the road, railway so that the quantity of earthwork both in cutting and filling should be minimum.

5) To find out the capacity of the reservoir or a volume of earthwork especially in the Mountainous region.

6) For preparing contour map in order to select the most economical or suitable site.

7) As its definition itself indicates the line joining the points of same elevation that Means it naturally prefers the condition of nature of ground itself.

8) It is also used for irrigation purpose as from it capacity of reservoir is shown.

LOCATING CONTOURS:

a) By cross-section method:

This method is commonly used in rough survey, cross sections are run traverse to the contour line of road, and railway as canal and the point of change of slope (representations) are located. The cross-section line may be inclined at any angle To the centerline if necessary. The spacing of the cross sections depends upon the characteristics of the ground.

By interpolation of contour is meant the process of spacing the contour proportioning between the plotted ground points. Contour may be interpolated by

1) Estimation

2) Arithmetical calculations

3) Graphical method .in all these methods

uniform.

RESULT: The contour of given land is drawn in the sheet.

AIM : Study of Planimeter

APPARATUS : Planimeter

FIGURE :

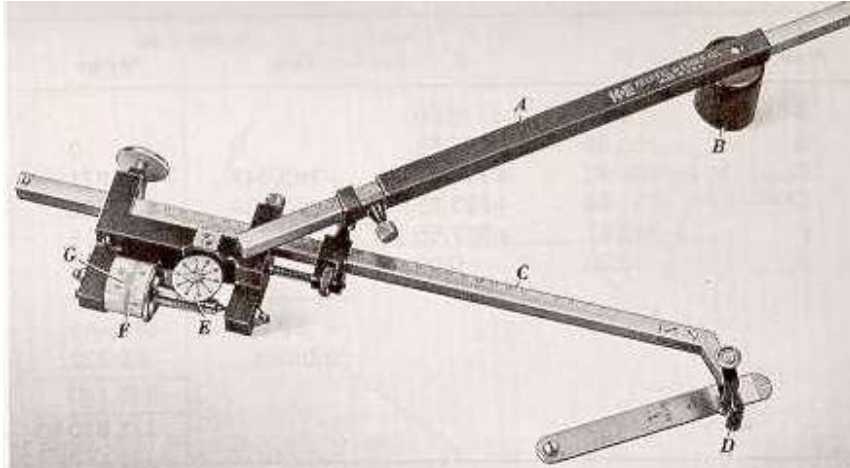

Planimeter : A Planimeter is a mechanical integrator is used by engineer for measuring area of figure which is been plotted scale particularly when the boundaries are irregular are curved mathematically it is difficult to find the area of such irregular figures. Planimeter is largely used for finding the areas of contour in determining the capacity of storage server.

Construction: These are several types of Planimeter but the anpler polar Planimeter is in most common use & is described as-

It consists of two arms hinged at a point one is known is anchor arm & it is at fixed length. It has a needle point called the anchor point which is fixed in paper & hold in position by detachable small weight the other arm is called trussing arm. it carries a tracing point which is moved along the periphery of the figure of which the area is to be found out . Tracing arm is adjustable is length the tracing arm is set to position given by the manufacturer according to scale used the total normal displacement is measured b rolling wheel. The rolling wheel carries graduated drum divided into 100

connected by gears is the counting disc. The counting disc measure one revolution at every 10 turns of the rolling wheel each complete reading is a figure of four digits. The zero of rolling wheel is opposite to the zero at vernier. Actually the marks of rise should be opposite to index mark due to imperfection of the wheel gear.

Instrument is equipped with magnifying glass to read vernier & a check bar or flat bar for testing the Planimeter.

Reading on Planimeter:

Each complete reading on Planimeter is a figure of four digits. Let the reading be 4.375 the first digit 4 is read on the disc the second digit 3 is read on the rolling wheel (main scale) the third digit 7 is read on the rolling wheel (main scale) & the last is fourth digit 5 is read on the vernier scale beside the main scale of rolling wheel position of measuring unit (setting of tracing arm) the position of tracing arm is adjustable according to given position by the manufacture for the different scalar. The position of measuring unit will be vary from instrument to the index mark on the beveled edge of the tracing arm of the figure may be obtained directly in m^2 or hectares by marking use of multiplying scale factor.

Method of using Planimeter:

The Planimeter is used in determining the areas of the figure in 2 ways.

- 1) By placing the anchor point outside the figure.
- 2) By placing the anchor point inside the figure.

Procedure: 1) Set out the index arm on the tracing arm to the given scale as per manufactures instruction exactly by using clamp & fine motion screw. Stretch the sheet making free from wrinkles.

Mark the points on the boundaries of the figure & set tracing arm exactly over it.

3) Now take the initial reading i.e. the reading on dial & wheel & vernier.

4) Move the tracing point along the periphery of the figure & stop at the starting point.

5) While tracing point is moved note the number of times the zero index mark in clockwise & anticlockwise direction. Again take the reading of on dial wheel & vernier that will be final reading.

6) The calculated area (A) = $m (FR-IR + 10N+C)$

Where, M=multiplying constant which is different scales

N=number of times the zero of dial passes the fixed index mark use the +ve sign when moves clockwise & -ve sign moves anticlockwise.

C= constant of instrument supplied by manufacture & different for different scales & it is offset when anchor point is kept inside otherwise it is taken zero if it is kept outside.

FR=Final reading.

IB= Initial reading.

Area of the zero circles i.e. M_c is defined as the correction circle which is defined as a circle found the circumference at which if the tracing point is moved wheel will slide without rotation in a reading. This is possible when tracing arm is placed in such a position relative to the anchor of arm that the plane of the roller passes through the anchored point the multiply constant of Planimeter is equal to the number of unit of area per revolution of the roller.

RESULT: - Planimeter has been used to measured irregular figure.

AIM : Determination of area of irregular figure by using planimeter

APPARATUS : Planimeter

FIGURE :

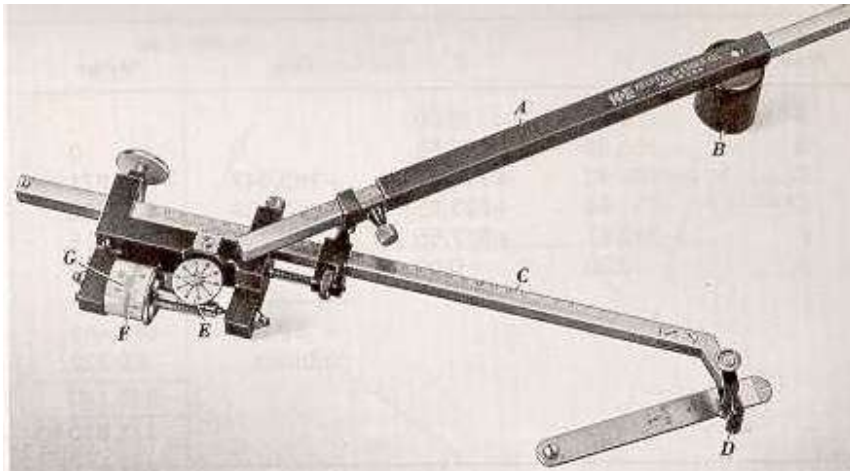

Planimeter : A Planimeter is a mechanical integrator is used by engineer for measuring area of figure which is been plotted scale particularly when the boundaries are irregular are curved mathematically it is difficult to find the area of such irregular figures. Planimeter is largely used for finding the areas of contour in determining the capacity of storage server.

Method of using planimeter

The planimeter is used in determining the area of the figure in two ways.

- 1) By placing the anchor point outside the figure and
- 2) By placing the anchor point inside the figure.

If the figure is large the anchor point may be kept inside while if it small the same may be placed outside. The larger figure may be divided into parts and the area of each part is measured separately and the results so obtained are added together to get required area.

The procedure is common for both the above cases.

- 1) Set out the index arm on the tracing arm (position of measuring unit), to given scale as per manufactures instruction, exactly by using the clamp and fine motion screw.
- 2) Stretch the map sheet until it is flat and free from wrinkles.
- 3) Fix the anchor point firmly in the paper outside or inside the figure according as the figure is small or large.
- 4) Mark a point on the boundary of the figure and set the tracing point exactly over it.
- 5) Now take initial reading (I.R) as described previously, reading the dial, wheel and vernier. It is not necessary to set the dial and wheel to zero.
- 6) Move the tracing point exactly around the boundary, always in clockwise direction using one hand to keep the point exactly on the boundary and the other hand to keep the anchor point from moving, stop exactly at the starting point.
- 7) While tracing point is moved along the boundary of the figure, note the number of times the zero mark in clockwise or anticlockwise direction. Again take the reading of dial ,wheel and vernier recording it as the final reading (F.R) .The area of the figure is then calculated by using the following formula.

$$\text{The calculated area (A) = m (FR-IR + 10N+C)}$$

Where, M=multiplying constant which is different for different scales and supplied in the instruction sheet by the manufacture. It is equal to the area of one revaluation of the wheel i.e unit area.

F.R.= the final reading

I.R= the initial reading

moves clockwise & -ve sign moves anticlockwise.

C= constant of instrument supplied by manufacture & different for different scales & it is offset when anchor point is kept inside otherwise it is taken zero if it is kept outside.

Area of the zero circles i.e. M_c is defined as the correction circle which is defined as a circle found the circumference at which if the tracing point is moved wheel will slide without rotation in a reading. This is possible when tracing arm is placed in such a position relative to the anchor of arm that the plane of the roller passes through the anchored point the multiply constant of Planimeter is equal to the number of unit of area per revolution of the roller.

Observation table:-

Position of anchor point	Initial Reading	Final Reading	Value of N	Remark

Result: The area of irregular figure is found to be -----Sq-m

AIM : To Study of Abney level, Box sextant

APPARATUS : Abney level, Box sextant

FIGURE :



Abney level:-

Abney level is a light compact bond instrument of low elevation. It is widely used for-

Measuring the angle of elevation or depression.

- 1) Taking alone of the ground when chaining along the uneven ground.
- 2) Tracing a great contour or a alignment of a road.

Abney level consist of-

- 1) A square lighting tube fitted with an eye piece or small telescope at one end at the other end the mirror is placed at an angle of 45° inside the tube the wire is lanced across the tube behind the mirror by which object can be bisected.
- 2) A small bubble tube is attached to the mirror arm which can be rotated by means of worm wheel.
- 3) A semicircular quadrate arch is marked zero at the middle point. The graduation are made from $0^{\circ} - 6^{\circ}$

Measurement of vertical angle

Direct the instrument towards the object & bisect it with crass wire & at the same times the middle wheel until the crass wire bisect the reflection of the required angle in the arc by means of the vernier it may be noted that the bubble tube is always horizontal & the vertical arm vertical , whatever may be the inclination of telescope.

Survey-I

The observer stands at one end of the slope & direct the instrument on to the mark all vane fixed on the ranging rod at the same height as the observer wheel until the reflected image of the bubble is brought to the centre of its run & intersected by the cross wire the bubble tube is now horizontal while the telescope is parallel to the slope of the ground. The angle read on the arc gives the slope of the ground.

To trace the grade contour:-

With the help of the vernier the rolling gradient can be obtained mark the height of the observer on the ranging rod. Direct the instrument towards the mark on the ranging rod held at the convenient distance say 30-50meter the ranging rod is then moved upward downward until the observer bisect the vane with cross hair & simultaneously over the bubbled centered is the instrument station to the point on which ranging rod is held parallel to this point & repeat the process to establish the next point the process is continued until the last point is established.

If the abney level is not giving correct values of angle of inclination of there is difference of two observations then adjust the instrument to the mean value. i.e. $(T_1+T_2/2)$ light the object & centre the bubble by means of adjusting screw of the bubble tube.

It is reflected type of instrument capable of measuring angle up to 120° & reads to one minute.



Construction: - it consist of –

- ii. A box about 7.5 cm in dia & 4cm in depth
- iii. A cover which server as a handle when occurred to the bottom.
- iv. A horizontal glass having the lower half & the nipper half.
- v. An index glass wholly.
- vi. A Oliver all graduated from 0° to 140° degrees & half degrees.
- vii. An index arm carries a vernier which reads to single minute.
- viii. An adjustable magnifying glass.
- ix. A milled handle screw to rotate the index glass & index arm.
- x. An eye hole in a sliding arm.
- xi. A pair of colored glasses for use when observations are taken on the brought object or the sun.

- xiii. A slot in the side of the box through which enters the rays from the object sighted.
- xiv. A bay for adjusting the instrument.

Uses:- The box sextant is a compact hand instrument by setting the vernier to 90 it may be used as a optical square & therefore after included in the instrument (equipment) For a chain survey it is very useful for measuring chain angles. Locating inaccessible point at measuring angles for checking purpose.

PROCEDURE:-

When measuring angles between the two objects at a station hold the instrument is the right hand over the station & look through the eye lenses at the left hand object through the lower position of the horizontal angle. The middle headed screw slowly until the image of the right hand object seen is the upper silvered half of the horizon glass is with left hand.

Note- the reading of vernires which gives the value of the required angle.

RESULT:- Abney level, Box sextant is studied.

AIM : To give Layout for given plan of building.

Equipment: Pegs, Nails ,Lime, Wooden Mallet

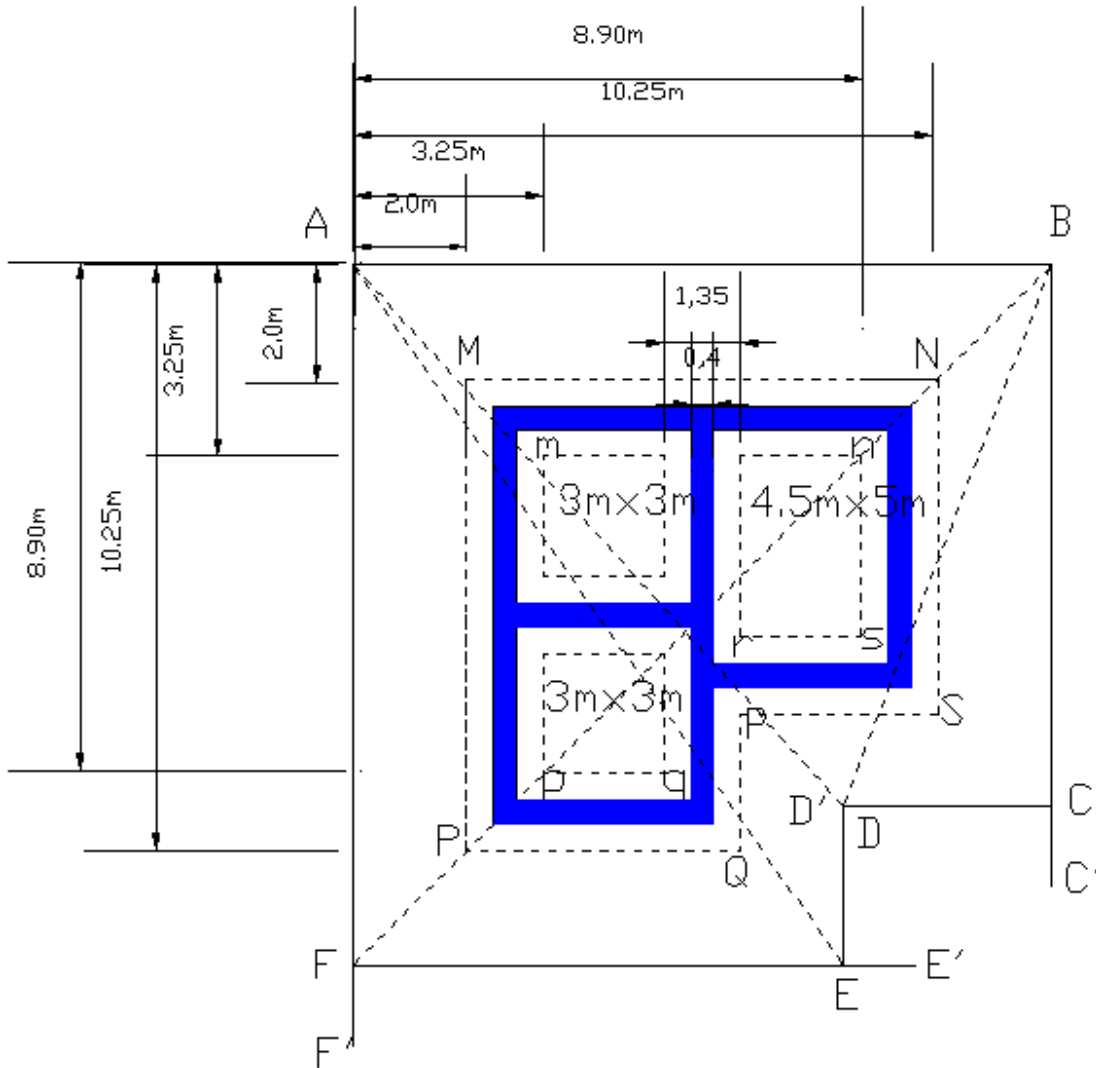

Theory: - When plans are ready for the works, the works are to be executed. To start with any structure first of all, trenches for the foundation are to be excavated. To excavate these trenches, the outline of excavation are defined on the ground, the process of defining the outlines of the excavation on the ground is known as setting out of works or lining out of works.

line, the plan showing the width of the foundation trench, for various walls, distance of the corners from some definite line etc. is required. This plan called foundation plan (Fig) .The distances and they are with reference to lines AB and AF.

PROCEDURE :-

To start with the setting out of building ,first of all a point A is fixed and then line AB is oriented in the required direction .Thus having fixed the direction of the line AB, two pegs A and B are driven at distance of 12.25m,apart (This distance calculated from the plan). Wire nails are driven at the centers of the pegs. Again the distance between the wire nails is checked and which should be equal to 12.25m. A cord is stretched along AB and ends are secured to these wire nails at A and B, perpendicular AF' and BC' are setout. Perpendicular may be set with a tape by 3-4-5 method or theodolite may be used if the work is important. Along AF' and BC', point F and C are fixed at 12.80m and 10.30m, from A&B respectively .The perpendicular are then set at C and F and point D and E are fixed along CD' and FE' at a calculated distance from C and F respectively . The stakes are driven at these point C, D, E, and F and wire nails are driven at the centers of these stakes. A cord is stretched all along ABCDEF.

To check up the work, the diagonal AE, AD, bF, and Bd are actually measured and these measured values should agree with their corresponding calculated lengths. Otherwise the setting out work should be repeated and stakes should be refixed at their correct positions.

After fixing up all the pegs and stretching the cord the corners M,N,P etc and m,n,p etc. are to be located . The point A is considered as the origin and the lines

etc., and m, n, p, etc. are calculated with reference to A as origin .

For example Co-ordinates of M,N,P are (2,2),(2,10.25) and (10.25,2) respectively and those for m,n,p are (3.35,3.35),(3.35,8.90) and (8.90,3.35) respectively. With these co-ordinates, point M,N,P,m,n,p etc., are set and pegs are driven at these points. The cord are stretched around the wire nails at M,N,P,Q,R,S and m,n,p,r,s indicating peripheries. The outline of the peripheries are marked with lime spread.

Now the lime lines on the ground indicate the trenches for the various walls and the excavation may be started .if during the progress of the work, the lines marked are disturbed, it may be checked or reset with help of reference line ABCDEF.