

# LECTURE NOTES

ON

## HYDRAULIC & IRRIGATION ENGINEERING

Diploma in Civil Engineering (4<sup>th</sup> Semester)

By

**Mrs. Rajashree Nayak**

Lecturer, Civil Engineering Department



DEPARTMENT OF CIVIL ENGINEERING  
Govt. Polytechnic, Jajpur

## UNIT – 1

### **CROP WATER REQUIREMENT**

Need and classification of irrigation- historical development and merits and demerits of irrigation- types of crops-crop season-duty, delta and base period- consumptive use of crops- estimation of Evapotranspiration using experimental and theoretical methods.

#### **Irrigation- Definition**

- Irrigation is an artificial application of water to the soil.
- It is usually used to assist the growing of crops in dry areas and during periods of inadequate rainfall.

#### **Need of the Irrigation**

- India is basically an agricultural country, and all its resources depend on the agricultural.
- Water is evidently the most vital element in the plant life.
- Water is normally supplied to the plants by nature through rains.
- However, the total rainfall in a particular area may be either insufficient, or ill-timed.
- Systematic irrigation system – Collecting water during the period of excess rainfall & releasing it to the crop when it is needed.

#### **Less rainfall:**

- Artificial supply is necessary
- Irrigation work may be constructed at a place where more water is available & then convey the water where there is less rainfall.

#### **Non uniform rainfall:**

- Rainfall may not be uniform over the crop period in the particular area.
- Rains may be available during the starting period of crop but no water may be available at end, with the result yield may be less or crop may be die.
- Collection of water during the excess rainfall & supplied to the crop during the period when there may be no rainfall.

#### **Commercial crops with additional water:**

- Rainfall may be sufficient to raise the usual crop but more water may be necessary for raising commercial & cash crop . ( Sugarcane, Tea, Tobacco, cotton, cardamom, & indigo)

## Controlled water supply:

- Yield of the crop may be increased by the construction of proper distribution system

## Benefits of Irrigation:

- Increase in food production
- Protection from famine
- Cultivation of cash crop ( Sugarcane, Tobacco, & cotton)
- Addition to the wealth of the country
- Increase the prosperity of people
- Generation of hydro-electric power
- Domestic & industrial water supply
- Inland navigation
- Improvement of communication
- Canal plantations
- Improvement in the ground water storage
- General development of the country.

## Types of Irrigation OR Classification of Irrigation:

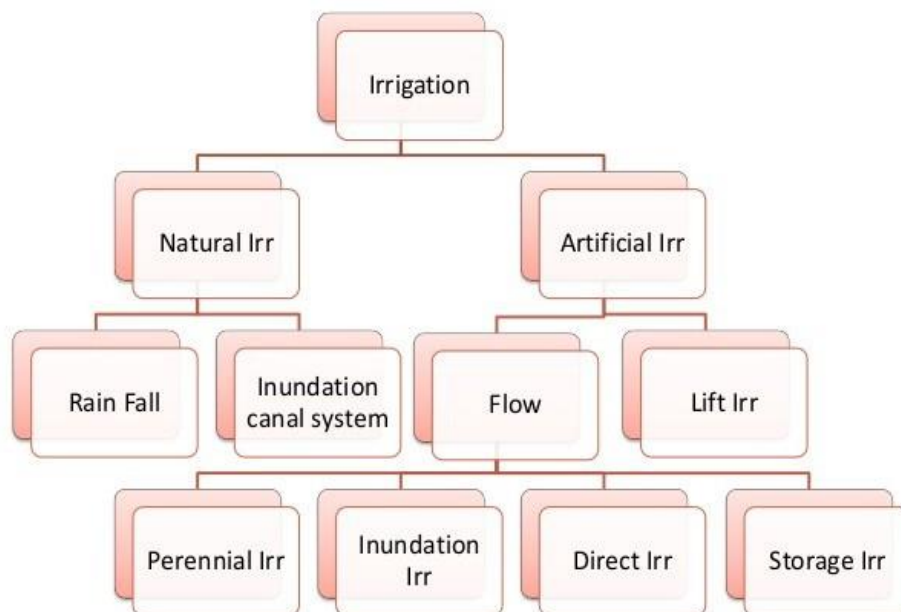

### Natural Irrigation

- No engineering structure is constructed.

#### 1) Rainfall Irrigation

- Rainfall is only used for raising crops.

#### 2) Inundation canal system

- Flood water is utilized for Irrigation purpose by properly direction flow of water.

### **Artificial Irrigation**

- Properly designed engineering structure are constructed.

#### **1) Flow irrigation**

- Water flows to the irrigated land by gravity.
- Water sources is to be higher level than the irrigated land.

#### **a) Perennial irrigation :**

Water is supplied according to the requirements throughout the crop period through storage canal head works & Canal distribution system.

#### **b) Inundation irrigation:**

- Lands are submerged & thoroughly flooded when floods occur in the river.
- Lands are allowed to drain off & the crop are sown.
- Now the soil retains sufficient moisture for the crops to grow.

#### **c) Direct irrigation :**

- Water is directly diverted to the canal from the river is called Direct irrigation.
- Discharge in the river shall be higher than the water requirement during the crop period.
- A low diversion weir or a barrage is constructed across the river to rise the water level and divert the same to the canal.
- Direct irrigation can be adopted only where there is enough flow in the river to provide sufficient quantity of water required for irrigation throughout the crop period.

#### **d) Storage Irrigation:**

- River flow is not perennial or insufficient during crop period, Storage Irrigation is adopted.
- A dam is construction across the river to store water in the reservoir.
- In some area rain water that run off from a catchment area is stored in tanks and is used for irrigation during the crop period.

#### **2) Lift or well Irrigation:**

- Water is lifted up by mechanical such as pump etc or manual to supply for irrigation .
- Lift irrigation is adopted when the water source is lower than the level of lands to be irrigated.

### **Historical development of Irrigation**

- Historically, civilizations have been dependent on development of irrigated agriculture.
- Archaeological investigation has identified evidence of irrigation in **Mesopotamia, Ancient Egypt & Ancient Persia** (at present Iran) as far back as the 6th millennium BCE.

- In the “**Zana**” valley of the Andes Mountain in **Peru**, archaeologists found remains of three irrigation canals radiocarbon dated from the 4th millennium BCE, the 3rd Millennium BCE & the 9th century CE, These canals are the earliest record of irrigation in the new world.
- The **Indus valley** civilization in Pakistan & North India (from 2600 BCE) also had an early canal irrigation system. Large scale agriculture was used for the purpose of irrigation.
- There is evidence of **ancient Egyptian** Pharaoh Amenemhet-III in the 12th dynasty (about 1800 BCE) using the natural lake of the Faiyum Oasis as a reservoir to store surpluses of water for use during the dry seasons, the lake swelled annually from flooding of the Nile.
- The irrigation works of **ancient Sri Lanka**, the earliest dating from about 300 BCE, in the reign of King Pandukabhaya & under conditions development for the next thousand years, were one of the most complex irrigation systems of the ancient world.
- In the Szechwan region **ancient China** the Dujiangyan Irrigation System was built in 250 BCE to irrigate a large area & it still supplies water today.
- In the **Americas**, extensive irrigation systems were created by numerous groups in prehistoric times. One example is seen in the recent archaeological excavations near the Santa Cruz River in Tucson, Arizona. They have located a village site dating from 4000 years ago.

#### **Present status of Irrigation:**

- In the middle of 20th century, the advent of diesel & electric motors led for the first time to system that could pump groundwater out of major aquifers faster than it was recharged.
- This can lead to permanent loss of aquifer capacity, decreased water quality, ground subsidence & other problems.
- The largest contiguous areas of high irrigation density are found in North India & Pakistan along the rivers Ganges & Indus, in the Hai He, Huang He & Yangtze basins in China, along the Nile River in Egypt & Sudan, in the Mississippi-Missouri river basin & in parts of California.

#### **Developmental Aspects of Irrigation:**

Irrigation is practiced to maintain the different developmental parameters. Those are:

1. To make up for the soil moisture deficit.
2. To ensure a proper & sustained growth of crops.
3. To make harvest safe.
4. To colonize the cultivable wasteland for horizontal expansion of cultivation.
5. To shift from seasonal cultivation.
6. To promote more intensive cultivation by multiple cropping.
7. To improve the level of agricultural productivity by acting as an agent for adoption of modern technology.
8. To lessen the regional & size-class inequalities in agricultural productivity that will reduce in turn socio-economic imbalances.

## **Advantages of irrigation**

Advantages of irrigation can be direct as well as indirect.

### **I. Direct Benefits**

- The grower has many choices of crops and varieties and can go for multiple cropping for cultivation
- Crop plants respond to fertilizer and other inputs and there by productivity is high.
- Quality of the crop is improved.
- Higher economic return and employment opportunities. It makes economy drought proof.
- Development of pisciculture and afforestation. Plantation is raised along the banks of canals and field boundaries.
- Domestic water supply, hydel power generation at dam site and means of transport where navigation is possible.
- Prevention of damage through flood.

### **II. Indirect Benefits**

- Increase in gross domestic product of the country, revenue, employment, land value, higher wages to farm labour, agro-based industries and groundwater storage.
- General development of other sectors and development of the country
- Increase of food production.
- Modify soil or climate environment – leaching.
- Lessen risk of catastrophic damage caused by drought.
- Increase income & national cash flow.
- Increase labor employment.
- Increase standard of living.
- Increase value of land.
- National security thus self sufficiency.
- Improve communication and navigation facilities.
- Domestic and industrial water supply.
- Improve ground water storage.
- Generation of hydro-electric power.

### **Disadvantages of Irrigation**

The following are the disadvantages of irrigation.

- Water logging.
- Salinity and alkalinity of land.
- Ill aeration of soil.

- Pollution of underground water.
- Results in colder and damper climate causing outbreak of diseases like malaria.

### Types of Crops:

- 1) **Wet crops**- which lands are irrigated and than crop are cultivation
- 2) **Dry crops**-which do not need irrigation.
- 3) **Garden crops**- which need irrigation throughout the year
- 4) **Summer crop (Kharif)**-which are sown during the south west monsoon & harvested in autumn.
- 5) **Winter crops( rabi)**-which are sown in autumn & harvested in spring.
- 6) **Cash crop** – which has to be encased in the market. As it cannot be consumed directly by the cultivators.

S.No	Crop	Sown	Harvested
1	Summer season (Kharif crop)		
	Rice	June -July	Oct-Nov
	Maize	June -July	Sep-Oct
	Bajra	June -Aug	Sep-Oct
	Jowar	June -July	Oct-Nov
	Pulses	June -July	Nov-Dec
2	Winter season (Rabi Crops)		
	Wheat, Barley, peas	Oct-Nov	March - April
	Gram	Sep- Oct	March - April
	Tobacco	Feb-Mar	June
	Potato	Oct	Feb
3	Eight Months Crop cotton	May-June	Dec-Jan
4	Annual crop sugercane	Feb-March	Dec-march

Crop

### Seasons:

- In north India the crop season is divided as Rabi & Kharif.

- Rabi crops are called as winter crops and kharif crops are called as summer crops.
- Kharif crops required more water than rabi crops.
- Rabi starts from 1 st oct and ends on 31 march
- In TamilNadu crops are classified as wet and dry crops.

### **Crops rotation:**

Rotation of crops implies the nature of the crop sown in a particular field is changed year after year.

### **Necessity for rotation**

- The necessity for irrigation when the same crop is grown again and again in the same field, the fertility of land gets reduced as the soil becomes deficient in plant foods favorable to that particular crop.
- If different crops were to be raised there would certainly be more balanced feeding and soil deficient in one particular type of nutrient is allowed to recouped.
- Crop diseases and insect pests will multiply at an alarming rate, if the same crop is to be grown continuously. Rotation will check the diseases.
- A leguminous crop (such as gram) if introduced in rotation will increase nitrogen content of soil thus increasing its fertility.
- The deep rooted and shallow rooted crops in rotation draw their food from different depths of soil. The soil will be better utilized.
- Rotation of crops is beneficial to the farmers as there would be rotation of cash crops, fooder and soil renovating crops.

### **General rotation of crops can be summarized as:**

1. Wheat – great millet – gram.
2. Rice – gram
3. Cotton – wheat – gram.
4. Cotton – wheat – sugarcane
5. Cotton – great millet – gram.

### **Consumptive Use of Water**

- Considerable part of water applied for irrigation is lost by evaporation & transpiration.
- This two processes being difficult to separate are taken as one and called Vapor-transpiration or Consumptive use of water.

### **Duty :**

Duty- Area of the crop irrigated/ Volume of water required.

### **Delta:**

- The depth of water required every time, generally varies depending upon the type of the crop.



- The total depth of water required a crop to nature is called delta.
- Crop period-the time from the instant of its sowing to the instant of harvesting.
- Base Period-time b/w the first supply of water to the land and the last watering before harvesting.

### **Factor affecting the duty:**

#### **1) Soil Moisture**

- In clayey soil less water is required since its retentive capacity is more.
- Pervious soil it will be more.

#### **2) Topography**

- Uniform distribution depends on topography.
- If the area is sloping the lower portion will get more water than the flat portion, & hence Water requirement is increase.

#### **3) Nature of rainfall**

- If rainfall is high over the crop period water requirement becomes less, otherwise it will be more.

#### **4) Nature of crop irrigated**

- Dry crop required less water where as wed crop required more water.

#### **5) Method of cultivation:**

- If the fields are properly ploughed it will have high retentive capacity & the number of watering are reduced.

#### **6) Season of crop**

- Less irrigation water is required for rainy season crop and the duty increased.
- If the crop grown in summer, more irrigation water is required & the duty gets decreased

#### **7) System of Irrigation**

- In perennial irrigation, continuous supply of water is given & hence water table is kept high & percolation losses is minimized
- In inundation type wastage is more by deep percolation.

#### **8) Canal Condition**

- Well maintained canal will have more duty as the losses is less.

### **Improving Duty**

1. The water losses can be reduced by having the irrigated area nearer to the head of the canal.
2. Evaporation losses can be minimized by using the water as quickly as possible.

3. Water losses can be minimized by lining the canals.
4. The cultivators should be trained to use water economically without wasting.
5. The soil properties should be studied by establishing research stations in villages.

**Crop Period or Base Period:**

- The time period that elapses from the instant of its sowing to the instant of its harvesting is called the **crop period**.
- The time between the first watering of a crop at the time of its sowing to its last watering before harvesting is called the **base period**.

**Duty and Delta of a Crop Delta:**

The total quantity of water required by the crop for its full growth may be expressed in hectare-meter or simply as depth to which water would stand on the irrigated area if the total quantity supplied were to stand above the surface without percolation or evaporation. This total depth of water is called delta ( $\Delta$ ).

**Problem –1:** If rice requires about 10 cm depth of water at an average interval of about 10 days, and the crop period for rice is 120 days, find out the delta for rice.

**Solution:**

$$\text{No. of watering required} = 120/10 = 12$$

$$\text{Total depth of water required in 120 days} = 10 \times 12 = 120 \text{ cm}$$

$$\Delta \text{ for rice} = 120 \text{ cm}$$

**Problem –2:** If wheat requires about 7.5 cm of water after every 28 days, and the base period for wheat is 140 days, find out the value of delta for wheat.

**Solution:**

$$\text{No. of watering required} = 140/28 = 5$$

$$\text{Total depth of water required in 140 days} = 7.5 \times 5 = 37.5 \text{ cm}$$

$$\Delta \text{ for wheat} = 37.5 \text{ cm}$$

**Duty:**

- It may be defined as the number of hectares of land irrigated for full growth of a given crop by supply of 1 m<sup>3</sup>/s of water continuously during the entire base of that crop.
- Simply we can say that, the area (in hectares) of land can be irrigated for a crop period, B (in days) using one cubic meter of water.

**Factors on which duty depends:**

1. Type of crop

2. Climate and season
3. Useful rainfall
4. Type of soil
5. Efficiency of cultivation method

### **Importance of Duty**

- It helps us in designing an efficient canal irrigation system.
- Knowing the total available water at the head of a main canal, and the overall duty for all the crops required to be irrigated in different seasons of the year, the area which can be irrigated can be worked out.
- *Inversely, if we know the crops area required to be irrigated and their duties, we can work out the discharge required for designing the channel.*

### **Measures for improving duty of water:**

The duty of canal water can certainly be improved by effecting economy in the use of water by resorting to the following precautions and practices:

#### **(1) Proper Ploughing:**

Ploughing should be done properly and deeply so that the moisture retaining capacity of soil is increased.

#### **(2) Methods of supplying water:**

The method of supplying water to the agriculture land should be decided according to the field and soil conditions. For example,

- Furrow method For crops sown in rows
- Contour method For hilly areas
- Basin For orchards
- Flooding For plain lands

#### **(3) Canal Lining:**

It is provided to reduce percolation loss and evaporation loss due to high velocity.

#### **(4) Minimum idle length of irrigation Canals:**

The canal should be nearest to the command area so that idle length of the canal is minimum and hence reduced transmission losses.

#### **(5) Quality of water:**

Good quality of water should be used for irrigation. Pollution en route the canal should be avoided.

## **(6) Crop rotation:**

The principle of crop rotation should be adopted to increase the moisture retaining capacity and fertility of the soil.

### **Consumptive use of crops**

#### **Definition:**

- It is the quantity of water used by the vegetation growth of a given area.
- It is the amount of water required by a crop for its vegetated growth to evapotranspiration and building of plant tissues plus evaporation from soils and intercepted precipitation.
- It is expressed in terms of depth of water. Consumptive use varies with temperature, humidity, wind speed, topography, sunlight hours, method of irrigation, moisture availability.

Mathematically,

$$\text{Consumptive Use} = \text{Evapotranspiration} = \text{Evaporation} + \text{transpiration}$$

- It is expressed in terms of depth of water.

### **Factors Affecting the Consumptive Use of Water**

Consumptive use of water varies with:

1. Evaporation which depends on humidity
2. Mean Monthly temperature
3. Growing season of crops and cropping pattern
4. Monthly precipitation in area
5. Wind velocity in locality
6. Soil and topography
7. Irrigation practices and method of irrigation
8. Sunlight hours

### **Types of Consumptive Water Use**

Following are the types of consumptive use,

1. Optimum Consumptive Use
2. Potential Consumptive Use
3. Seasonal Consumptive Use

#### **1. Optimum Consumptive Use:**

It is the consumptive use which produces a maximum crop yield.

## 2. Potential Consumptive Use:

If sufficient moisture is always available to completely meet the needs of vegetation fully covering the entire area then resulting evapotranspiration is known as Potential Consumptive Use.

## 3. Seasonal Consumptive Use:

The total amount of water used in the evapo-transpiration by a cropped area during the entire growing season.

## Crop Water Requirements

### Soil moisture

### Classes and availability of soil water

Water present in the soil may be to classified under three heads

1. Hygroscopic water
2. Capillary water
3. Gravitational water

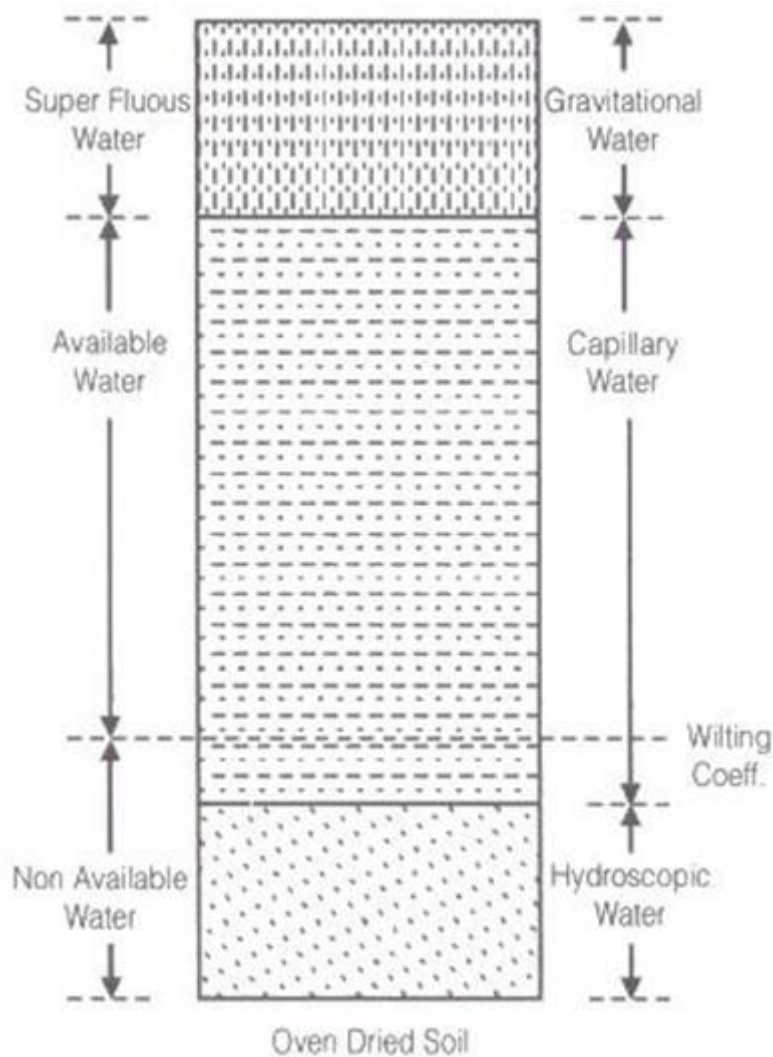

### Hygroscopic water

Water attached to soil particles through loose chemical bonds is termed hygroscopic water. This water can be removed by heat only. But the plant roots can use a very small fraction of this soil moisture under drought conditions.

### Capillary water

The capillary water is held within soil pores due to the surface tension forces (against gravity) which act at the liquid-vapour (or water-air) interface.

### Gravitational water

Gravity water is that water which drains away under the influence of gravity. Soon after irrigation (or rainfall), this water remains in the soil and saturates the soil, thus, preventing circulation of air in the void spaces.

(1) Available moisture for the plant =  $F_C - \phi$

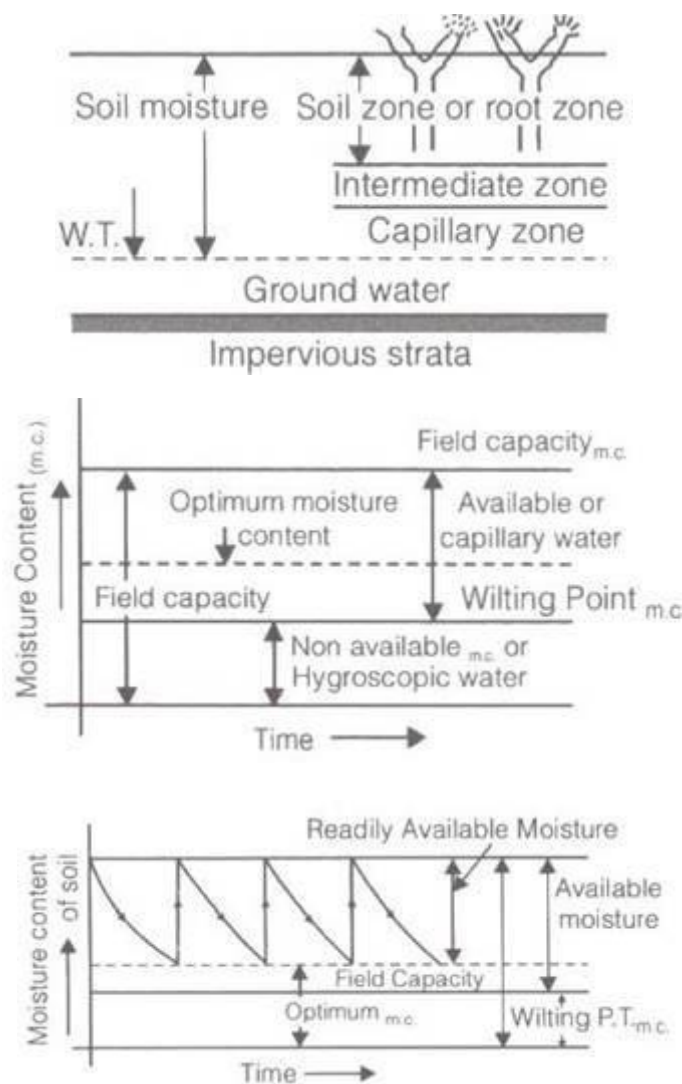

(2) Readily available moisture for the plant =  $FC - M_o$

Here FC= field capacity

$\phi$  = wilting point or wilting coefficient below plant can't survive.

Mo= Readily available moisture content

$$(3) \text{ Frequency of Irrigation} = \frac{\text{weight / readily available moisture depth}}{\text{consumptive use rate}}$$

$$(4) F_C = \frac{\text{weight of water stored in soil of unit area}}{\text{weight of same soil of unit area}}$$

where, weight of water stored in soil of unit area =  $\gamma_w \cdot d_w \cdot 1$ .

Weight of some soil of unit area =  $\gamma \cdot d \cdot 1$

$d_w$  = depth of water stored in root zone.

$$(5) d_w = \frac{\gamma \cdot d}{\gamma_w} \cdot F_C \quad \gamma \rightarrow \text{dry unit wt. of soil}$$

$$(6) \text{ Available moisture depth to plant } d_w' = \frac{\gamma \cdot d}{\gamma_w} (F_C - \phi)$$

$$(7) \text{ Readily available moisture depth to plant } d_w' = \frac{\gamma \cdot d}{\gamma_w} (F_C - m_o)$$

$$(8) F_C = n / G \quad \text{where, } G = \text{specific gravity and } n = \text{porosity}$$

### Duty and delta

#### Duty:

- The duty of water is the relationship between the volume of water and the area of the crop it matures.
- It is defined as the area irrigated per cumec of discharge running for base period B.
- The duty is generally represent by D.

#### Delta:

- It is the total depth of water required by a crop during the entire base period and is represented by the symbol  $\Delta$ .

#### Relation between duty and delta

$$\Delta = \frac{8.64B}{D}$$

Where,

- $\Delta$  = Delta in meter
- D = Duty in Ha/cumec
- B = Base period in days

$$\text{Also } \Delta = \frac{2B}{D}$$

Where,

- $\Delta$  = Delta in meter
- B = Base period in days
- D = Duty in acre/cures

### **Irrigation Requirements of crops**

#### **(1) Consumptive Irrigation Requirement (CIR)**

$$CIR = C_u - P_{eff}$$

Where,  $C_u$  = total consumptive use requirement

$P_{eff}$  = Effective rainfall.

#### **(2) Net Irrigation Requirement (NIR)**

$$NIR = CIR + \text{Leaching requirement}$$

#### **(3) Field irrigation requirement (FIR)**

$$FIR = \frac{NIR}{\eta_a}$$

#### **(4) Gross irrigation requirement, (GIR)**

$$GIR = \frac{FIR}{\eta_c}$$

### **Methods of Determination of Evapotranspiration**

To measure or estimation the consumptive use there are three main methods:

1. Direct Methods/Field Methods
2. Empirical Methods
3. Pan evaporation method

#### **1. Direct Methods:**

In this method field observations are made and physical model is used for this purpose. This includes,

- i. Vapour Transfer Method/Soil Moisture Studies
- ii. Field Plot Method
- iii. Tanks and Lysimeter
- iv. Integration Method/Summation Method
- v. Irrigation Method
- vi. Inflow Outflow Method



### **i. Vapour Transfer Method:**

In this method of estimation of water consumptive use, soil moisture measurements are taken before and after each irrigation. The quantity of water extracted per day from soil is computed for each period. A curve is drawn by plotting the rate of use against time and from this curve, the seasonal use can be estimated. This method is suitable in those areas where soil is fairly uniform and ground water is deep enough so that it does not affect the fluctuations in the soil moisture within the root zone of the soil.

It is expressed in terms of volume i.e. **Acre-feet** or **Hectare-meter**

### **ii. Field Plot Method:**

We select a representative plot of area and the accuracy depends upon the representativeness of plot (cropping intensity, exposure etc). It replicates the conditions of an actual sample field (field plot). Less seepage should be there.

$$\text{Inflow} + \text{Rain} + \text{Outflow} = \text{Evapotranspiration}$$

The drawback in this method is that lateral movement of water takes place although more representative to field condition. Also some correction has to be applied for deep percolation as it cannot be ascertained in the field.

### **iii. Tanks and Lysimeter:**

In this method of measurement of consumptive use of water, a watertight tank of cylindrical shape having diameter 2m and depth about 3m is placed vertically on the ground. The tank is filled with sample of soil. The bottom of the tank consists of a sand layer and a pan for collecting the surplus water. The plants grown in the Lysimeter should be the same as in the surrounding field. The consumptive use of water is estimated by measuring the amount of water required for the satisfactory growth of the plants within the tanks. Consumptive use of water is given by,

$$\text{Cu} = \text{Wa} - \text{Wd}$$

*Where,*

Cu = Consumptive use of water

Wa = Water Applied

Wd = Water drained off

Lysimeter studies are time consuming and expensive. Methods 1 and 2 are the more reliable methods as compare to this method.

#### **iv. Integration Method:**

In this method, it is necessary to know the division of total area, i.e. under irrigated crops, natural native vegetation area, water surface area and bare land area. In this method, annual consumptive use for the whole area is found in terms of volume. It is expressed in Acre feet or Hectare meter.

*Mathematically,*

$$\text{Total Evapotranspiration} = \text{Total consumptive use} \times \text{Total Area}$$

$$\text{Total Area Annual Consumptive Use} = \text{Total Evapotranspiration} = A+B+C+D$$

Where,

A = Unit consumptive use for each crop's area

B = Unit consumptive use of native vegetation's area

C = Water surface evaporation's area

D = Bare land evaporation's area

#### **v. Irrigation Method:**

In this method, unit consumption is multiplied by some factor. The multiplication values depend upon the type of crops in certain area. This method requires an Engineer judgment as these factors are to be investigated by the Engineers of certain area.

#### **vi. Inflow Outflow Method:**

In this method annual consumptive use is found for large areas. If U is the valley consumptive use its value is given by,

$$U = (I+P) + (G_s - G_e) - R$$

*Where,*

U = Valley consumptive use (in acre feet or hectare meter)

I = Total inflow during a year

P = Yearly precipitation on valley floor

G<sub>s</sub> = Ground Storage at the beginning of the year

G<sub>e</sub> = Ground Storage at the end of the year

R = Yearly Outflow

## **2. Empirical Methods:**

Empirical equations are given for the estimation of water requirement. These are,

- a) Blaney-Criddle method
- b) Lowry Johnson Method

- c) Penman Equation
- d) Hargreave's Method

**a. Blaney-Criddle method:**

- Blaney and Criddle (1950) observed that the amount of water consumptively used by crops during their growing seasons was closely correlated with mean monthly temperatures and daylight hours and the length of the growing seasons.
- The correlation coefficients are then applied to determine the ET for other areas where only climate data are available.
- Blaney-Criddle formula is one of the best known procedures for estimating Potential Evapotranspiration (PET) and is widely used.
- The popularity of the procedure is due to its simplicity and its use of readily available data.
- It requires the use of only two factors, namely, temperature which is readily available from the weather stations and information on daylight hours which is a factor based purely on the latitude of the place.
- Blaney-Criddle equation expresses the consumptive use in terms of temperature and day time hours.

If CU is monthly consumptive use, its value is given by  $C_u = K.f$  (inches)

Where, k = crop factor to be determined for each crop; its value depends upon Certain environmental conditions

f = monthly consumptive use factor

=  $t \times (p/100)$

t = mean temperature in °F.

p = percentage of day time hours of the year, occurring during the period.

If Expressed in metric units, the above formula becomes:

$$C_u = k \cdot \frac{p}{40} [1.8t + 32] = k.f$$

Where,

t = temperature in °C

$C_u$  = monthly consumptive use in cm

**b. Lowry Johnson Method:**

The equation for this method is,

$$U = 0.0015 H + 0.9 \text{ (Over specified)}$$

U = Consumptive Use

H = Accumulated degree days during the growing season computed from maximum temperature above 32 °F

### c. Penman Equation:

Penman(1948) proposed an equation for evaporation from open water surface, based on a combination of energy balance and sink strength which is given below with changes in certain symbols in view of the recent trends.

According to this method,

$$U = ET = AH + 0.27 EaA - 0.27$$

ET = Evapotranspiration or consumptive use in mm Ea = Evaporation (mm/day)

H = Daily head budget at surface (mm/day)

H is a function of radiation, sunshine hours, wind speed, vapour pressure and other climatic factors.

A = Slope of saturated vapour pressure curve of air at absolute temperature in °F

### d. Hargreave's Method:

- It is a very simple method.
- The pan is circular with a diameter of 1.21 m and depth of 255 mm which gives it a volume of about 0.3 m<sup>3</sup>.
- The basin is put on a 150 mm high wooden frame due to air circulation around the basin. The water level is kept about 50 mm below the rim, due to allowance of percolation and the need of water.
- The water level is measured every day, either you measure the difference between the present and the origin water level or if you have chosen to obtain the water level in the pan, you measure the amount of water you have put into the pan.

According to this method,

$$Cu = KEp$$

*Where,*

Cu = Consumptive Use coefficient (varies from crop to crop)

Ep = Evapotranspiration

K = Coefficient

\*\*\*\*\*

## UNIT-2

### IRRIGATION METHODS

Tank irrigation – Well irrigation – Irrigation methods: Surface and Sub-Surface and Micro Irrigation – design of drip and sprinkler irrigation – ridge and furrow irrigation-Irrigation scheduling – Water distribution system- Irrigation efficiencies.

#### **Tank irrigation**

- A tank is a reservoir for irrigation, a small lake or pool made by damming the valley of a stream to retain the monsoon rain for later use.
- It accounts for approximately 3% of the net irrigated area in India.
- Tank Irrigation is popular in the peninsular plateau area where Andhra Pradesh and Tamil Nadu are the leading states.
- Andhra Pradesh has the largest area (29%) of tank irrigation in India followed by Tamil Nadu (23%).
- Tanks are known as Ery in Tamil. The temple tanks of Tamil Nadu are known as Kulam

#### **Kinds of Tanks**

- The tanks are of two kinds viz., System Tanks and Non-System Tanks.
- The canal fed tanks are known as System Tanks, which were exclusively under the management of the Public Works Department.
- The System Tanks are fed with water from rivers and run off through diversion weirs, feeder channels and surface flow.
- System Tanks are the minority of tanks that are supplied from major storage canal irrigation systems or from perennial rivers.
- The rainfed tanks are known as Non-System Tanks.
- Non-System Tanks which command area below 40 hectares are coming under the control of Panchayat Unions.
- These Non-System Tanks have a small storage capacity.

**It is practised mainly in the peninsular region due to the following reasons:**

1. The undulating relief and hard rocks make it difficult to dig canals and wells
2. There is little percolation of water due to hard rock structure and ground water is not available in large quantities.
3. Most of the rivers are seasonal; there are many streams which become torrential during the rainy season – so the only way to use this water is to impound it by constructing bunds and building tanks. Also, it is easy to collect rainwater in natural or artificial pits because of impermeable rocks.
4. Scattered nature of agricultural fields

### **Merits**

- Most of the tanks are natural and do not involve cost for their construction
- Independent source for an individual farmer or a small group of farmers
- longer life span
- can be used for fishing also

### **Demerits**

- Depends on rain and these tanks may dry up during the dry season
- Silting of their beds
- Require large areas
- Evaporation losses
- Sometimes there might be a need to lift the water to take it to the field

### **Wells (and Tube Wells)**

- A well is a hole dug in the ground to obtain the subsoil water. An ordinary well is about 3-5 metres deep but deeper wells up to 15 metres are also dug.
- This method of irrigation has been used in India from time immemorial. Various methods are used to lift the ground water from the well.
- Some of the widely used methods are the persian wheel, reht, charas or mot, and dthingly (lever) etc.
- A tube well is a deeper well (generally over 15 metres deep) from which water is lifted with the help of a pumping set operated by an electric motor or a diesel engine.

### **Well Irrigation**

- Well irrigation is gradually giving way to energized tube wells. But there are many wells still in use where electricity is not available or the farmers are too poor to afford diesel oil.
- This method of irrigation is popular in those areas where sufficient sweet ground water is available.
- It is particularly suitable in areas with permeable rock structure which allows accumulation of ground water through percolation.
- Therefore wells are seen more in areas with alluvial soil, regur soil, etc. and less seen in rocky terrain or mountainous regions.
- These areas include a large part of the great northern plains, the deltaic regions of the Mahanadi, the Godavari, the Krishna and the Cauvery, parts of the Narmada and the Tapi

valleys and the weathered layers of the Deccan trap and crystalline rocks and the sedimentary zones of the peninsula

- However, the greater part of peninsular India is not suitable for well irrigation due to rocky structure, uneven surface and lack of underground water.
- Large dry tracts of Rajasthan, the adjoining parts of Punjab, Haryana and Gujarat and some parts of Up have brackish ground water which is not fit for irrigation and human consumption and hence unsuitable for well irrigation
- At present irrigation from wells and tubewells accounts for more than 60% of the net irrigated area in the country.
- UP has the largest area under well irrigation which accounts for 28% of the well irrigated area of the country. U.P., Rajasthan, Punjab, Madhya Pradesh, Gujarat, Bihar and Andhra Pradesh account for about three-fourths of the total well-irrigated area.

### **Merits of well irrigation**

- Simplest
- Cheapest
- Well is an independent source of irrigation and can be used as and when the necessity arises. Canal irrigation, on the other hand, is controlled by other agencies and cannot be used at will.
- Some ground water salts are useful for crops
- Does not lead to salinization and flooding problems
- There is a limit to the extent of canal irrigation beyond the tail end of the canal while a well can be dug at any convenient place.

### **Demerits**

- Only limited area can be irrigated.
- Normally, a well can irrigate 1 to 8 hectares of land.
- Not suitable for dry regions
- Overuse may lead to lowering of water table

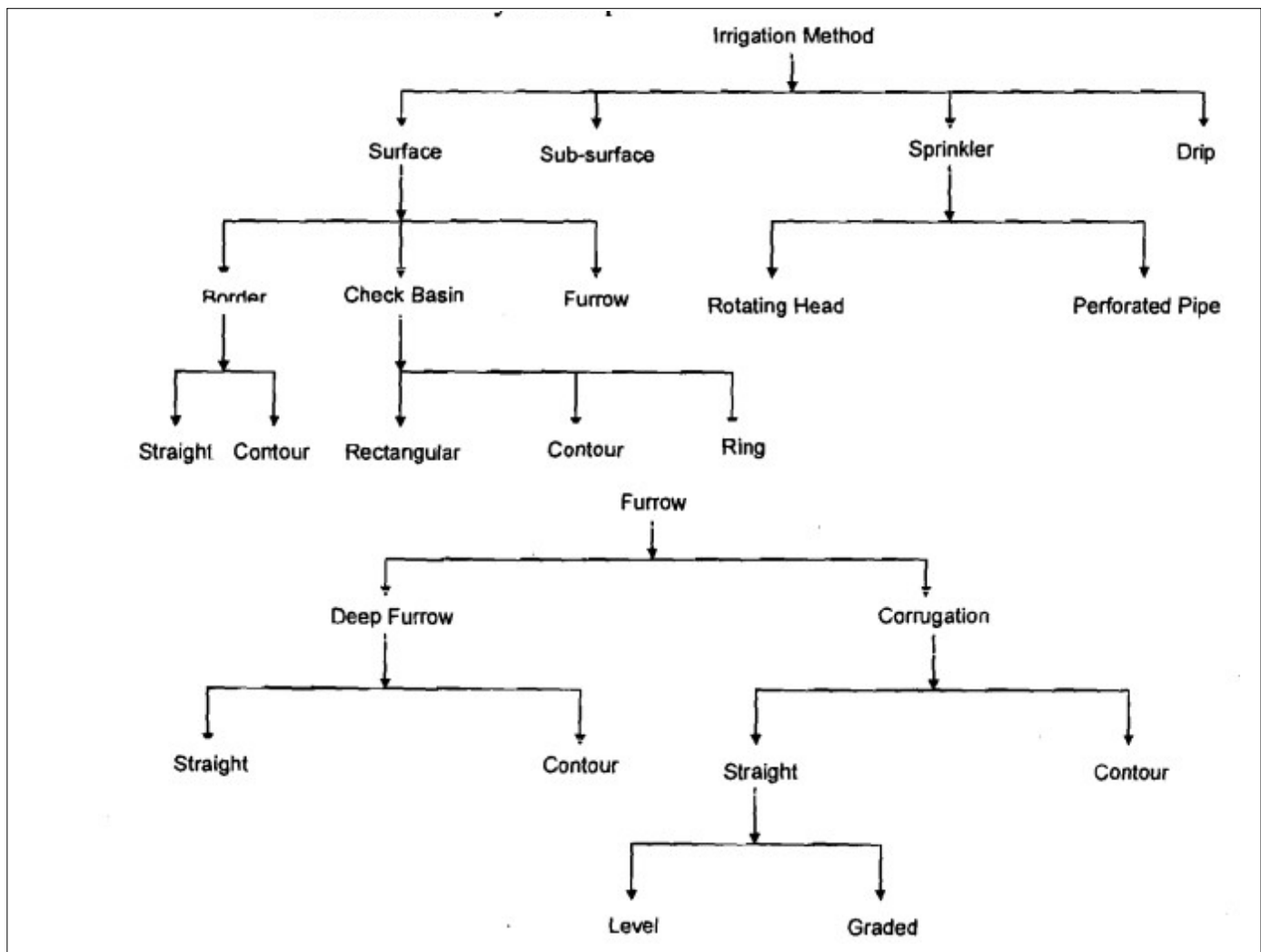

## **SURFACE IRRIGATION:**

- Surface irrigation is defined as the group of application techniques where water is applied and distributed over the soil surface by gravity.
- It is by far the most common form of irrigation throughout the world and has been practiced in many areas virtually unchanged for thousands of years.

### **Surface irrigation:**

There are four variations under this method viz.

1. Flooding,
2. Bed or border method (Saras and flat beds)
3. Basin method (ring and basin) and
4. Furrow method (rides and furrows, broad ridges or raised beds)

### **Flooding:**

- It consist of opening a water channel in a plot or field so that water can flow freely in all directions and cover the surface of the land in a continuous sheet.



- It is the most inefficient method of irrigation as only about 20 percent of the water is actually used by plants. The rest being lost as a runoff, seepage and evaporation.
- Water distribution is very uneven and crop growth is not uniform. It is suitable for uneven land where the cost of leveling is high and where a cheap and abundant supply of water is available.
- It is unsuitable for crops that are sensitive to water logging the method suitable where broadcast crops, particularly pastures, alfalfa, peas and small grains are produced.

**Adaptations:**

1. An abundant supply of water
2. Close growing crops
3. Soils that do not erode easily
4. Soils that is permeable
5. Irregular topography
6. Areas where water is cheap.

**Advantages:**

1. Can be used on shallow soils
2. Can be employed where expense of leveling is great
3. Installation and operation costs are low
4. System is not damaged by livestock and does not interfere with use of farm implements.

**Disadvantages:**

1. Excessive loss of water by run of and deep percolation
2. Excessive soil erosion on step land.
3. Fertilizer and FYM are eroded from the soil.

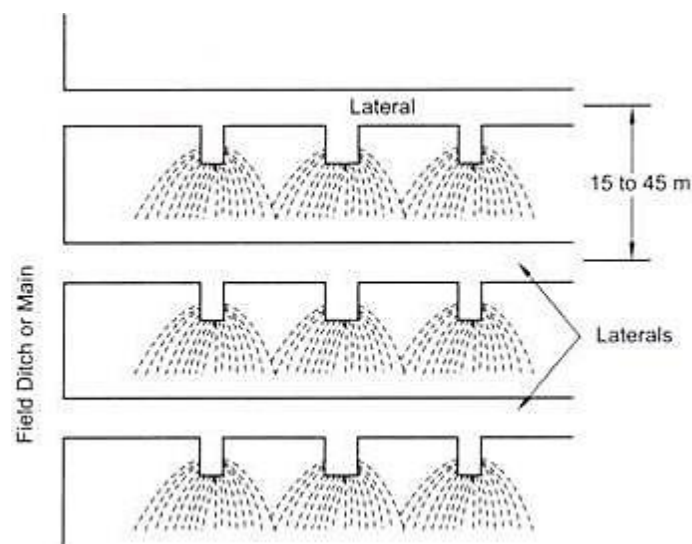

### **Bed or border method (Sara and Flat beds or check basin):**

- In this method the field is leveled and divided into small beds surrounded by bunds of 15 to 30 cm high. Small irrigation channels are provided between two adjacent rows of beds.
- The length of the bed varies from 30 meters for loamy soils to 90 meters for clayey soils.
- The width is so adjusted as to permit the water to flow evenly and wet the land uniformly.
- For high value crops, the beds may be still smaller especially where water is costly and not very abundant.
- This method is adaptable to most soil textures except sandy soils and is suitable for high value crops. It requires leveled land.
- It is more efficient in the use of water and ensures its uniform application. It is suitable for crops plant in lines or sown by broadcast. Through the initial cost is high requires less labour and low maintenance cost.
- This may also be called a sort of sara method followed locally in Maharashtra but the saras to be formed in this method are much longer than broader.

### **Types of Border Irrigation**

Two types of borders are formed :

- Straight Border
- These border are formed along the general slope of the field. These are preferred when fields can be levelled or be given a gentle slope economically.

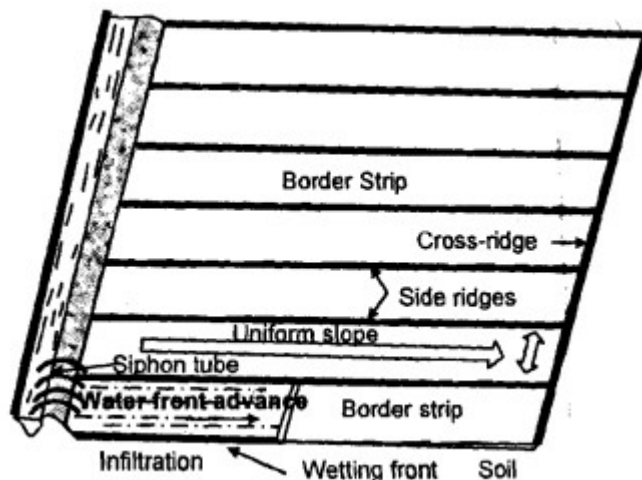

### **Contour Border**

- These are formed across the general slope of the field and are preferred when land slope exceeds the safe limits.

- As fields are undulating and require a lot of earth work to level, economical levelling is not possible. Design criteria for both are not different.

**Adaptations:**

1. A large supply of water
2. Most soil textures including sandy Loam, loams and clays
3. Soil at least 90 cm deep
4. Suitable for close growing crops.

**Advantages:**

1. Fairly large supply of water is needed.
2. Land must be leveled
3. Suited only to soils that do not readily disperse.
4. Drainage must be provided

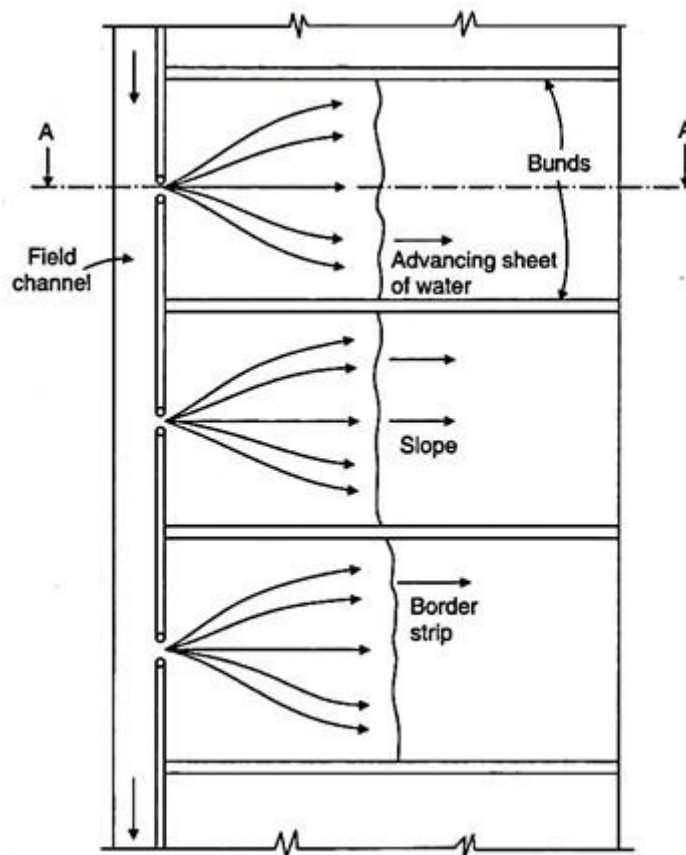

**Basin irrigation:**

- This method is suitable for orchards and other high value crops where the size of the plot to be irrigated is very small.

- The basin may be square, rectangular or circular shape. A variation in this method viz. ring and basin is commonly used for irrigating fruit trees.
- A small bund of 15 to 22 cm high is formed around the stump of the tree at a distance of about 30 to 60 cm to keep soil dry.
- The height of the outer bund varies depending upon the depth of water proposed to retain. Basin irrigation also requires leveled land and not suitable for all types of soil. It is also efficient in the use of water but its initial cost is high.
- There are many variations in its use, but all involve dividing the field into smaller unit areas so that each has a nearly level surface. Bunds or ridges are constructed around the areas forming basins within which the irrigation water can be controlled. Check basin types may be rectangular, contour and ring basin.

## **Types of Check Basins**

### **Based on Size and Shape**

The size of check basins may vary from one meters square, used for growing vegetables and other intensive cultivation, to as large as one or two hectares or more, used for growing rice under wet land conditions. While the following points need to be considered :

#### **Rectangular**

The basins are rectangular in shape when the land can be graded economically into nearly level fields.

#### **Contour**

- The ridges follow the contours of the land surface and the contour ridges are connected by cross ridges at intervals when there is rolling topography.
- The vertical interval between contour ridges usually varies from 6 to 12 cm in case of upland irrigated crops like wheat and 15 to 30 cm in case of low land irrigated crops like rice.

#### **Adaptations:**

1. Most soil texture
2. High value crops
3. Smooth topography.
4. High water value/ha

#### **Advantages:**

1. Varying supply of water

2. No water loss by run off
3. Rapid irrigation possible
4. No loss of fertilizers and organic manures
5. Satisfactory

**Disadvantages:**

1. If land is not leveled initial cost may be high
2. Suitable mainly for orchards, rice, jute, etc.
3. Except rice, not suitable for soils that disperse easily and readily from a crust.

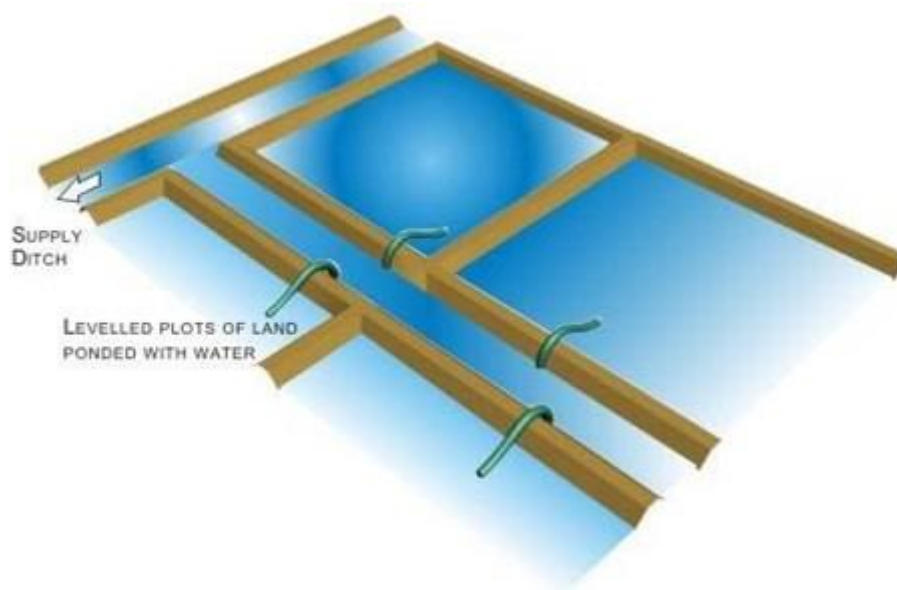

**Furrow Method**

- In this method, irrigation water is useful for row crops. Narrow channels are dug at regular intervals. Water from the main supply is allowed to enter these small channels or furrows.
- Water from the furrows infiltrates into soil and spread laterally to saturate the root zone of the crops.
- It is suitable for row crops like potatoes, sugarcane, tobacco, maize, groundnut, cotton, jowar, etc.
- Row crops such as potatoes, cotton, sugarcane, vegetable etc. can be irrigated by furrow method. Water is allowed to flow in furrow opened in crop rows.
- It is suitable for sloppy lands where the furrows are made along contours. The length of furrow is determined mostly by soil permeability.

- It varies from 3 to 6 meters. In sandy and clay loams, the length is shorter than in clay and clay loams. Water does not come in contact with the plant stems.
- There is a great economy in use of water. Some times, even in furrow irrigation the field is divided into beds having alternate ridges and furrows. On slopes of 1 to 3 percent, furrow irrigation with straight furrows is quite successful.
- But on steeper slopes contour furrows, not only check erosion but ensure uniform water penetration.

Irrigation furrows may be classified into two general types based on their alignment. They are :

(a) straight furrows, and

(b) contour furrows.

### **Straight Furrows**

- They are best suited to sites where the land slope does not exceed 0.75 per cent. In areas of intense rainfall, however, the furrow grade should not exceed 0.5 per cent so as to minimise the erosion hazard.
- The range in furrow slopes for efficient irrigation in different soil types are the same as those recommended for borders.

### **Contour Furrows**

- Contour furrows carry water across a sloping field rather than the slope. Contour furrows are curved to fit the topography of the land.
- Contour furrow method can be successfully used in nearly all irrigable soils. The limitations of straight furrow are overcome by contouring to include sloping lands. Light soils can be irrigated successfully across slopes up to 5 per cent.

### **Adaptations:**

1. Medium and fine textured soils.
2. Variable water supply
3. Farms with only small amount of equipment.

### **Advantages:**

1. High water efficiency
2. Can be used in any row crop
3. Relatively easy in stall
4. Not expensive to maintain

5. Adapted to most soils.

### **Disadvantages:**

1. Requirement of skilled labour is more
2. A hazard to operation of machinery
3. Drainage must be provided.

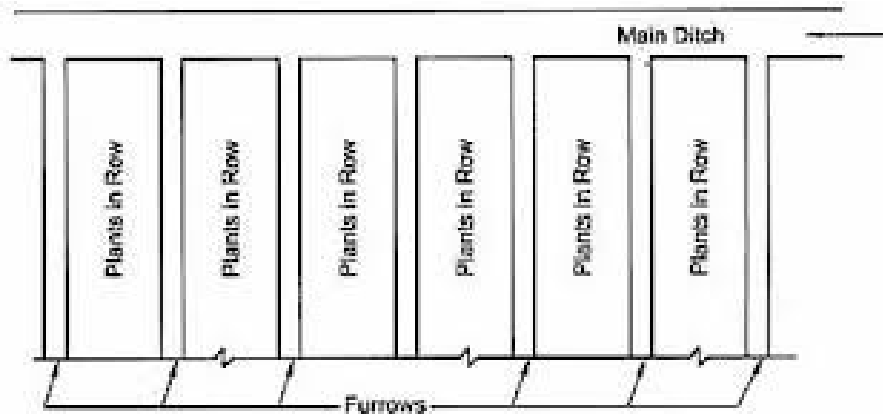

### **Contour farming**

- Contour farming involves ploughing, planting and weeding along the contour, i.e, across the slope rather than up and down.
- Contour lines are lines that run across a (hill) slope such that the line stays at the same height and does not run uphill or downhill.
- As contour lines travel across a hillside, they will be close together on the steeper parts of the hill and further apart on the gentle parts of the slope.
- Experiments show that contour farming alone can reduce soil erosion by as much as 50% on moderate slopes.
- However, for slopes steeper than 10%, other measures should be combined with contour farming to enhance its effectiveness.

### **Benefits :**

1. Contouring can reduce soil erosion by as much as 50% from up and down hill farming
2. By reducing sediment and run off and increasing water infiltration
3. Contouring promotes better water quality
4. It gives 10-15% additional yield.

### **Criteria for Surface Irrigation Method Selection**

- The deciding factors for the suitability of any surface irrigation method are natural conditions (slope, soil type), type of crop, required depth of application, level of technology, previous experiences with irrigation, required labour input.
- Moreover the irrigation system for a field must be compatible with the existing farming operations, such as land preparation, cultivation, and harvesting practices.
- The following outline lists a number of factors of the environment which will have a bearing on the evaluation of irrigation system alternates and the selection of a particular system.
- Not all points will be equally significant in each case, but the outline can serve as a useful checklist to prevent overlooking important factors.

### **Physical Factors**

- Crops and cultural practices are of prime importance while selecting an irrigation system.
- Hence, proper knowledge of agronomic practices and irrigation intervals is necessary for proper use of irrigation water and to increase water use efficiency.
- The following physical factors need to be given due consideration.

### **Crop Parameters**

- Tolerance of the crop to soil salinity during development and maturation.
- Magnitude and temporal distribution of water necessary for maximum production.
- Economic value of crop.

### **Soils Parameters**

- Texture and structure;infiltration rate and erosion potential;salinity and internal drainage, bearing strength.
- Sandy soils have a low water storage capacity and a high infiltration rate. Under these circumstances, sprinkler or drip irrigation are more suitable than surface irrigation. Clay soils with low infiltration rates are ideally suited to surface irrigation.
- High intake characteristicrequire higher flow rate to achieve the same uniformity and efficiency.
- Crusting of soil and its effects on infiltration
- Reclamation and salt leaching- basin irrigation
- Spatial variability

### **Field Topography**

- Uniform, mild slopes facilitate surface irrigation.



- Location and relative elevation of water source – water diversion, pumping
- Acreage in each field
- Location of roads, natural gas lines, electricity lines, water lines and other obstructions.
- Shape of field – non rectangular shapes are more difficult to design for
- Field slope – steepness & regularity
- Furrow&borders 2-6% maximum

### **Climate and Weather Conditions**

- Under very windy conditions, drip or surface irrigation methods are preferred.
- Scalding (the disruption of oxygen-carbon dioxide exchange between the atmosphere and the root)& the effect of water temperature on the crop at different stages of growth -risk in basin irrigation.
- Irrigation with cold water early in the spring can delay growth, whereas in the hot periods of the summer, it can cool the environment— both of which can be beneficial or detrimental in somecases.

### **Water Supply**

The following parameters are important:

1. Source and delivery schedule
2. Water quantity available and its reliability
3. Water quality
4. Water table in case of ground water source.
5. Availability and Reliability of Electricity
6. Availability and reliability of energy for pumping of water is of muchimportance.

### **Economic Considerations**

The following points need to be considered while selecting irrigation alternatives.

1. Capital investment required and recurring cost.
2. Credit availability and interest rate.
3. Life of irrigation system, efficiency and cost economics.

### **Social Considerations**

- The education and skill of common farmers and labours available for handling the irrigation system
- Social understanding of handling of cooperative activities and sharing of water resources
- Legal and political considerations, local cooperation and support, availability and skill of labour and level of automatic control

### **Suitability and Limitations of Surface Irrigation Methods**

- Some form of surface irrigation is adaptable to almost any vegetable crop. Basin and border strip irrigation have been successfully used on a wide variety of crops.
- Furrow irrigation is less well adapted to field crops if cultural practices require travel across the furrows. However, it is widely used in vegetables like potato.
- Basin and border strip irrigations flood the soil surface, and will cause some soils to form a crust, which may inhibit the sprouting of seeds.
- Surface irrigation systems perform better when soils are uniform, since the soil controls the intake of water. For basin irrigation, basin size should be appropriate for soil texture and infiltration rate.
- Basin lengths should be limited to 100 m on very coarse textured soils, but may reach 400 m on other soils. Furrow irrigation is possible with all types of soils, but extremely high or low intake rate soils require excessive labor or capital cost adjustments that are seldom economical.
- A major cost in surface irrigation is that of land grading or leveling. The cost is directly related to the volume of earth that must be moved, the area to be finished, and the length and size of farm canals.

### **MICRO IRRIGATION METHOD**

- Micro irrigation methods are precision irrigation methods of irrigation with very high irrigation water efficiency.
- In many parts of the country there is decline of irrigation water and conventional methods are having low water use efficiency.
- To surmount the problem, micro irrigation methods has recently been introduced in Indian agriculture.
- These methods save a substantial amount of water and helps increasing crop productivity particularly valuable cash crops like vegetables.

- The research results have confirmed a substantial saving of water ranging between 40 to 80% and there are reports of two times yield increase for different crops by using micro irrigation.

**Two main micro irrigation systems are :**

### **Advantages of Micro Irrigation**

- (a) Water saving, possibility of using saline water.
- (b) Efficient and economic use of fertilizers.
- (c) Easy installation, flexibility in operation.
- (d) Suitable to all types of land terrain also suitable to waste lands.
- (e) Enhanced plant growth and yield and uniform and better quality of produce.
- (f) Less weed growth.
- (g) Labour saving.
- (h) No soil erosion, saves land as no bunds, etc. are required.
- (i) Minimum diseases and pest infestation.

### **SPRINKLER IRRIGATION**

- In sprinkler irrigation, water is delivered through a pressurized pipe network to sprinklers nozzles or jets which spray the water into the air.
- To fall to the soil in an artificial "rain". The basic components of any sprinkler systems are : a water source. a pump to pressurize the water.
- A pipe network to distribute the water throughout the field. sprinklers to spray the water over the ground, and valves to control the flow of water.
- The sprinklers when properly spaced give a relatively uniform application of water over the irrigated area.

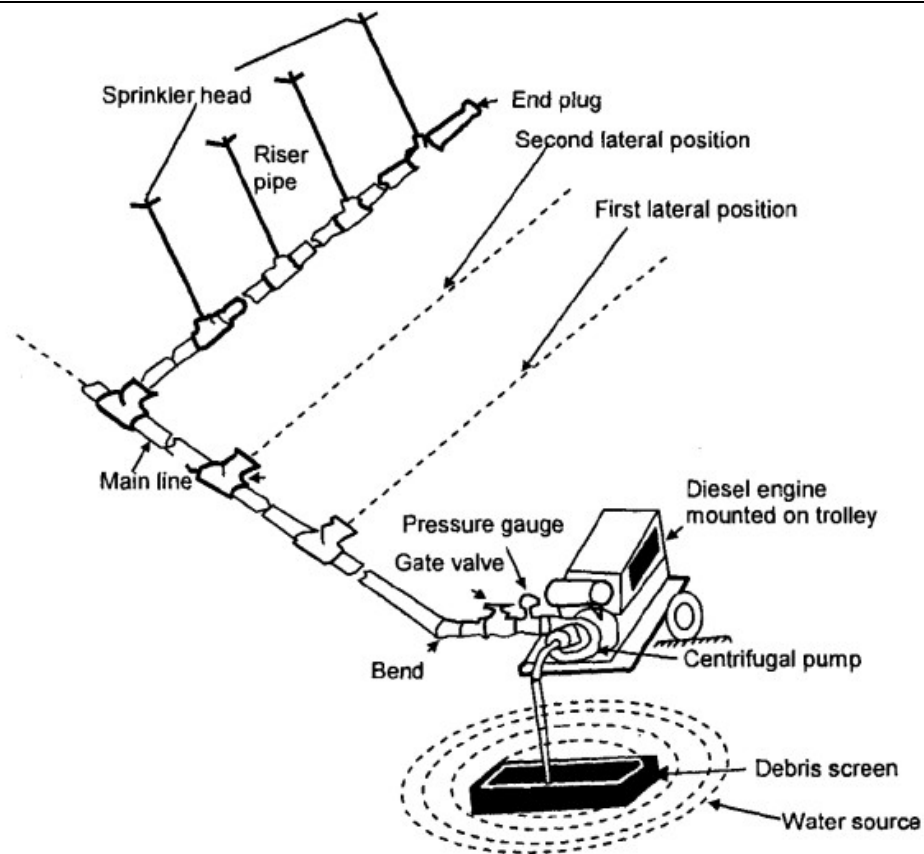

## Components of

## Sprinkler irrigation System

- Sprinkler systems are usually (there are some exceptions) designed to apply water at a lower rate than the soil infiltration rate so that the amount of water infiltrated at any point depends upon the application rate and time of application but not the soil infiltration rate.

### General Classification of Sprinkler Systems

Sprinkler systems are classified into the following two major types on the basis of the arrangement for spraying irrigation water.

- Rotating head or revolving sprinkler system.
- Perforated pipe system.

### Components of Sprinkler Irrigation System

Sprinkler system usually consists of the following components :

- A pump unit
- Tubings-main/sub-mains and laterals
- Couplers
- Sprinkler head
- Other accessories such as valves, bends, plugs and risers.

## **Suitability and Limitations**

With regards to crops, soils, and topography nearly all crops can be irrigated with some type of sprinkler system though the characteristics of the crop especially the height, must be considered in system selection.

Sprinklers are sometimes used to germinate seed and establish ground cover for crops like lettuce alfalfa and sod.

The light frequent applications that are desirable for this purpose are easily achieved with some sprinkler systems.

Sprinklers are applicable to soils that are too shallow to permit surface shaping or too variable for efficient surface irrigation.

In general, sprinklers can be used on any topography that can be formed. Land leveling is not normally required.

With regards to labour and energy considerations, it has been observed that labour requirements vary depending on the degree of automation and mechanization of the equipment used.

Hand-move systems require the least degree of skill, but the greatest amount of labor.

## **Advantages of Sprinkler Irrigation**

The followings are the advantages of sprinkler irrigation :

- (a) Elimination of the channels for conveyance, therefore no conveyance loss.
- (b) Suitable to all types of soil except heavy clay, suitable for irrigating crops where the plant population per unit area is very high. It is most suitable for oil seeds and other cereal and vegetable crops.
- (c) Water saving, closer control of water application convenient for giving light and frequent irrigation and higher water application efficiency.
- (d) Increase in yield.
- (e) Mobility of system.
- (f) May also be used for undulating area, saves land as no bunds etc. are required, areas located at a higher elevation than the source can be irrigated.
- (g) Influences greater conducive micro-climate.
- (h) Possibility of using soluble fertilizers and chemicals.
- (i) Less problem of clogging of sprinkler nozzles due to sediment laden water

## Capacity of Sprinkler System

The capacity of the sprinkler system may be calculated by the formula :

$$Q = 2780 \times \frac{A \times d}{F \times H \times E}$$

Where,

Q = Discharge capacity of the pump, liter/second,

A = Area to be irrigated, hectares,

d = Net depth of water application, cm,

F = Number of days allowed for the completion of  
one irrigation,

H = Number of actual operation hours per day, and

E = Water Application Efficiency in %

## DRIP IRRIGATION

- Drip irrigation, also known as trickle irrigation or microirrigation is an irrigation method which minimizes the use of water and fertilizer by allowing water to drip slowly to the roots of plants, either onto the soil surface or directly onto the root zone, through a network of valves, pipes, tubing, and emitters.
- It is becoming popular for row crop irrigation. This system is used in place of water scarcity as it minimizes conventional losses such as deep percolation, evaporation and run-off or recycled water is used for irrigation.
- Small diameter plastic pipes fitted with emitters or drippers at selected spacing to deliver the required quantity of water are used. Drip irrigation may also use devices called micro-spray heads, which spray water in a small area, instead of dripping emitters.
- Subsurface drip irrigation (SDI) uses permanently or temporarily buried drip per line or drip tape located at or below the plant roots.
- Pump and valves may be manually or automatically operated by a controller Drip irrigation is the slow, frequent application of water to the soil through emitters placed along a water delivery line.
- The term drip irrigation is general, and includes several more specific methods. Drip irrigation applies the water through small emitters to the soil surface, usually at or near the plant to be irrigated.

- Subsurface irrigation is the application of water below the soil surface. Emitter discharge rates for drip and subsurface irrigation are generally less than 12 liters per hour.

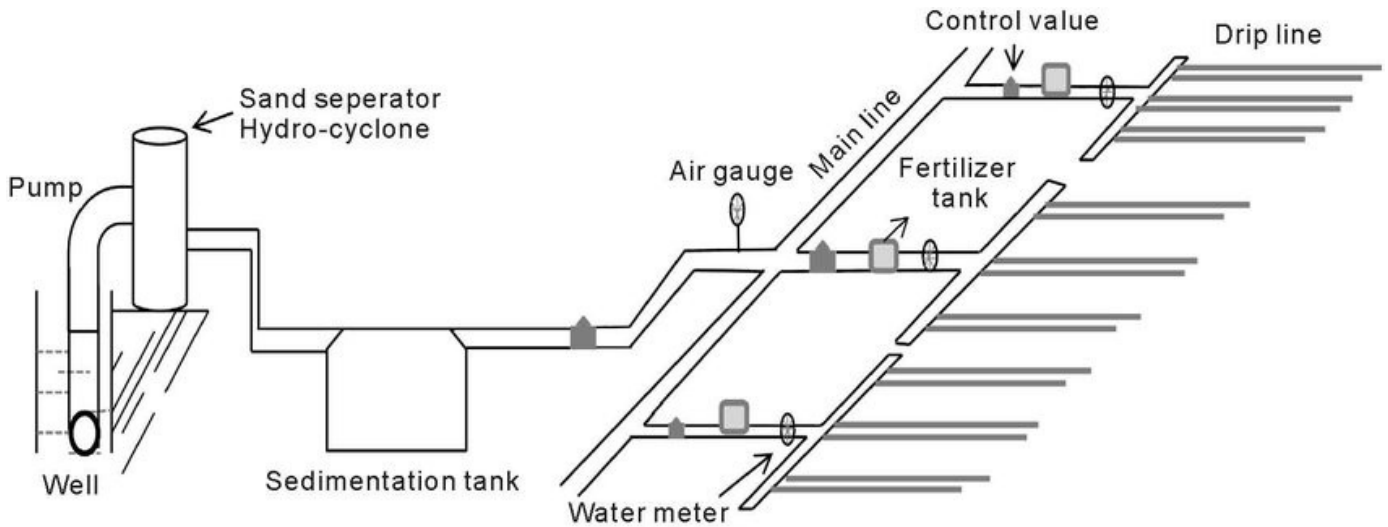

### Components of Drip Irrigation System (Listed in Order from Water Source)

- Pump or pressurised water source.
- Water Filter(s) - Filtration Systems : Sand Separator, Cyclone, Screen Filter, Media Filters.
- Fertigation Systems (Venturi injector).
- Backwash Controller.
- Main Line (larger diameter Pipe and Pipe Fittings).
- Hand-operated, electronic, or hydraulic Control Valves and Safety Valves.
- Smaller diameter polytube (often referred to as "laterals").
- Poly fittings and Accessories (to make connections).
- Emitting Devices at plants (Example : Emitter or Drippers, micro spray heads, inline drippers, trickle rings).

### Suitability:and Limitation

(a) From stand point of crops, soil, and topography, drip irrigation is best suited for tree, vine, and row crops. A lot of research work has been conducted to establish the suitability of drip irrigation for different vegetable crops. Drip irrigation has been found suitable both for field vegetable crops and also under covered cultivation practices.

(b) With respect to water quantity and quality, drip irrigation uses a slower rate of water application over a longer period of time than other irrigation methods. The most economical design would have

water flowing into the farm area throughout most of the day, every day, during peak use periods. If water is not available on a continuous basis, on-farm water storage may be necessary.

(c) Though a form of pressurized irrigation, drip is a low pressure, low flow rate method. These conditions require small flow channel openings in the emission devices, which are prone to plugging.

(d) High efficiencies are USP of drip irrigation system. Properly designed and maintained drip systems are capable of high efficiencies. Design efficiencies should be on the order of 90 to 95%.

(e) Labour and energy considerations are very important consideration in drip irrigation system. Due to their low flow characteristics, drip irrigation systems usually have few sub-units, and are designed for long irrigation times.

(f) Drip irrigation systems generally use less energy than other forms of pressurized irrigation systems. The emission devices usually operate at pressures ranging from 5 to 25 PSI. Additional pressure is required to compensate for pressure losses through the control head (filters and control valves) and the pipe network.

(g) Economic factors need special attention in case drip irrigation system as initial cost and operational cost is reasonably high. Drip systems costs can vary greatly. Depending on crop (plant. and therefore. emitter and hose spacings) and type of hose employed (permanent or "disposable" thin-walled tubing).

### **Advantages**

The advantages of drip irrigation are :

1. Minimised fertilizer/nutrient loss due to localized application and reduced leaching, allows safe use of recycled water.
2. High water distribution efficiency. Moisture within the root zone can be maintained at field capacity.
3. Leveling of the field not necessary. Soil type plays less important role in frequency of irrigation, minimised soil erosion.
4. Highly uniform distribution of water, i.e. controlled by output of each nozzle.
5. Lower labour cost.
6. Early maturity and good harvest.
7. Foliage remains dry thus reducing the risk of disease.

<b>Performance Indicator</b>	<b>Conventional Irrigation Methods</b>	<b>Drip Irrigation</b>
Water saving	Waste lot of water. Losses occur due to percolation, runoff and evaporation	40-70% of water can be saved over conventional irrigation methods. Runoff and deep percolation losses are nil or



		negligible.
Water use efficiency	30-50%, because losses are very high	80-95%
Saving in labour	Labour engaged per irrigation is higher than drip	Labour required only for operation and periodic maintenance of the system
Weed infestation	Weed infestation is very high	Less wetting of soil, weed infestation is very less or almost nil.
Use of saline water	Concentration of salts increases and adversely affects the plant growth. Saline water cannot be used for irrigation	Frequent irrigation keeps the salt concentration within root zone below harmful level
Diseases and pest problems	High	Relatively less because of less atmospheric humidity
Suitability in different soil Type	Deep percolation is more in light soil and with limited soil depths. Runoff loss is more in heavy soils	Suitable for all soil types as flow rate can be controlled
Water control	Inadequate	Very precise and easy
Efficiency of fertilizer use	Efficiency is low because of heavy losses due to leaching and runoff	Very high due to reduced loss of nutrients through leaching and runoff water
Soil erosion	Soil erosion is high because of large stream sizes used for irrigation.	Partial wetting of soil surface and slow application rates eliminate any possibility of soil erosion
Increase in crop yield	Non-uniformity in available moisture reducing the crop yield	Frequent watering eliminates moisture stress and yield can be increased up to 15- 150% as compared to conventional methods of irrigation.

#### Extent of Water Saving and Increase in Yield with Drip Irrigation Systems

Crops	Water Saving (%)	Increase in Yield (%)
Sugarcane	50	99
Tomato	42	60
Watermelon	66	19
Cucumber	56	45
Chili	68	28
Cauliflower	68	70
Okra	37	33
Ground nut	40	152
Mulberry	22	23
Banana	45	52
Grapes	48	23
Sweet lime	61	50
Pomegranate	45	45

Source : INCID 1994 Drip irrigation in India, New Delhi.

## FERTIGATION

- Fertigation is the process of application of water soluble solid fertilizer or liquid fertilizers through drip irrigation system.
- Through fertigation nutrients are applied directly into the wetted volume of soil immediately below the emitter where root activity is concentrated.
- Fertigation is practiced only in drip irrigation system. However, fertilizer solution can be added with sprinkler irrigation system also.

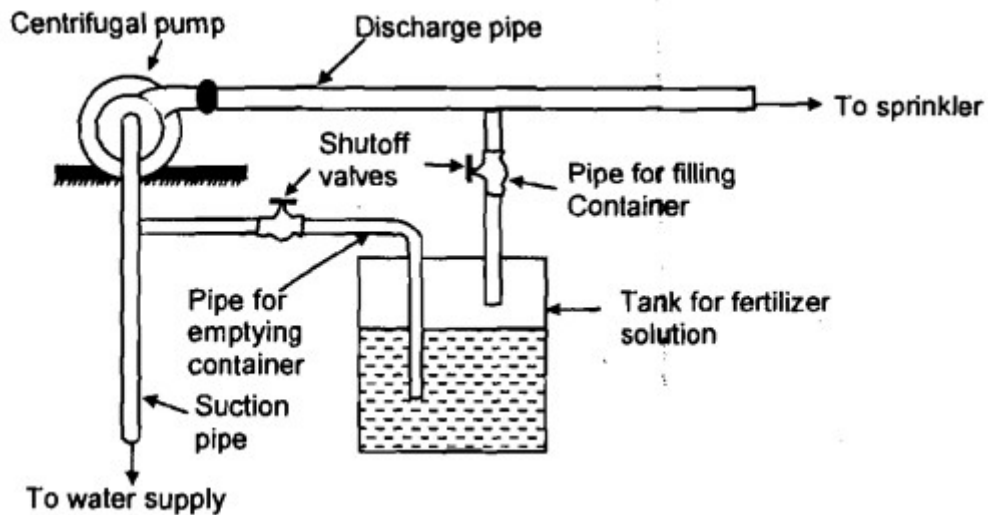

### Components of Fertigation

The main component of a fertigation is drip irrigation system. The main components are :

- (a) Venturi pump (injector)
- (b) Fertilizer tank with flow bypass
- (c) Pressure bypass tank
- (d) Injection pump.

### Advantages of Fertigation

1. The fertilizer solution is distributed evenly in the irrigation network with the same uniformity as the irrigation water.
2. The availability of nutrients including micro-nutrients is high, therefore the efficiency is very good.
3. The fertilizer system can also be used for other activities such as incorporating acid to flush the drip system.
4. It eliminates the work of spreading fertilizer. Manual spreading of fertilizer causes soil compaction and may damage the growing crop.

5. Fertilizer placement is exactly to the root zone of plant and can be uniformly applied through drip irrigation system.
6. All types of nutrients can be given simultaneously.
7. Lower doses of fertilizer could be applied daily or weekly (i.e. a large number of split application) to avoid leaching and fixation in soil.
8. Some liquid fertilizers are free of sodium and chloride salts, so these are not harmful to soil.
9. (i) Optimum production in light soil is possible.
10. Spraying with liquid fertilizer is possible.
11. Liquid fertilizers are immediately available to plants.
12. Fertilizer use efficiency can be increased by 25 to 30% over the tradition method of fertilizer application.
13. It decreases labour and energy cost.
14. The quality and quantity of crop production can be improved

### **Limitations**

- The fertigation system also has some limitations. The main one is the danger of poisoning people who drink the irrigation water particularly laborers those work on the farm.
- It is therefore necessary to warn the people in the field about drinking water separately and put up warning signs. The reverse flow of water mixed with fertilizer must be prevented.

### **Toxicity and Contamination**

Care must be taken whenever fertilizer solution is introduced into a water supply system.

### **Fertilizer Suitability**

Slowly water-soluble fertilizer such as super phosphate or calcium ammonium phosphate is not suitable. This method is suitable for liquid fertilizers or those that are readily soluble in water.

### **Corrosion**

The metallic parts of the equipment are highly prone to corrosion. Sensitive parts of the equipment must be made out of corrosion resistant materials and extra care should be taken when filling the tanks.

### **Keywords**

**Border Irrigation:** It uses land formed into strips which are located across the narrow dimension, but sloping along the long dimensions.

**Check Basin Irrigation** : In this irrigation system, water is applied to a completely level or dead level area enclosed by dikes or boarders.

**Furrow Irrigation** : Furrows are sloping channels formed in the soil. Infiltration occurs laterally and vertically through the wetted perimeter of the furrow and plants get water in its root zone.

**Sprinkler Irrigation** : In this system of irrigation, water is delivered through a pressurised pipe network to sprinklers nozzle or jets which spray water into the air.

**Drip Irrigation** : It minimises the use of water and fertilizer by allowing water to drip slowly to the roots of plants.

**Fertigation** : It is the process of application of water soluble solid fertilizer or liquid fertilizer through drip irrigation system.

### Water distribution system

Irrigation water may be applied to crops either by flooding the field. by applying water beneath the soil surface, by spraying it under pressure. or by applying it in drops. Selection of the suitable method, from among these methods, depends on topography. soil condition, land preparation, type of crop and its value. available water supply and other factors

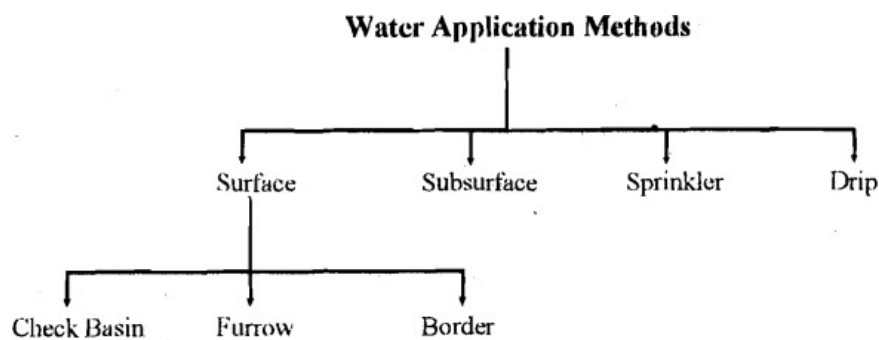

### CHECK BASIN IRRIGATION

Check basin irrigation or simply basin irrigation is the simplest available mode of irrigation and commonly practised in India and other countries. The principle underlying this system involves dividing the field or fanil into smaller unit areas such that each has a nearly level surface.

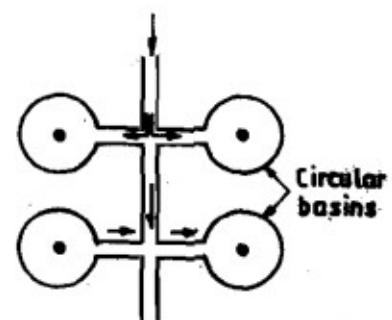
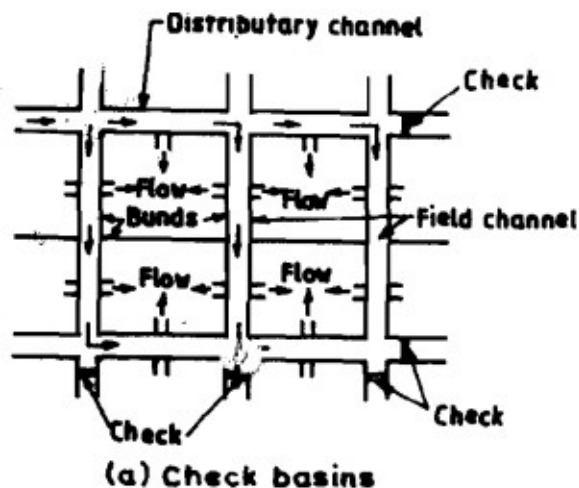

## Methods to Apply Irrigation Water to check Basins

There are two methods to supply irrigation water to check basins, namely, direct method, and cascade method.

In the direct method, irrigation water is led directly from the field channel into the basins through siphons or bund breaks. Basin A is irrigated first and then basin B and so on. This method can be used for most crop types, and is also suitable for most type of soil.

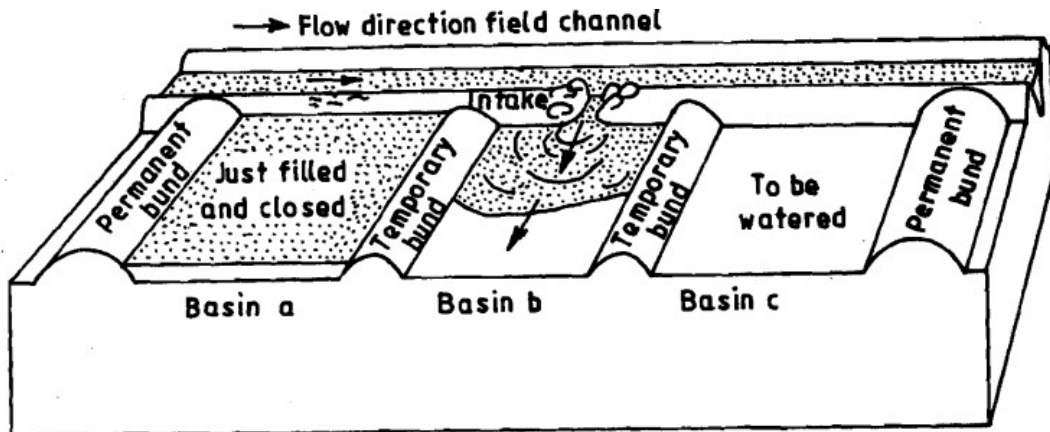

Direct Method

The other method, namely, the cascade method is suitable for sloping land where terraces are used. In this method, the irrigation water is supplied to the highest terrace, and then allowed to flow to a lower terrace and so on. In Figure water is supplied to the terrace A1 until the lowest terrace A3 is filled. The supply to A1 is then closed and irrigation water is diverted to terrace B1 until B1, B2 and B3 are filled, and so on.

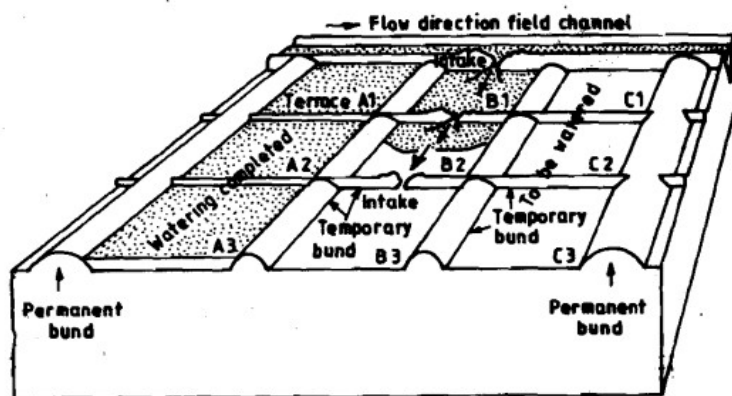

Cascade Method

## FURROW IRRIGATION

Furrows are small, parallel channels, made to carry water for irrigating the crops. The crops are usually grown on the ridges between the furrows.

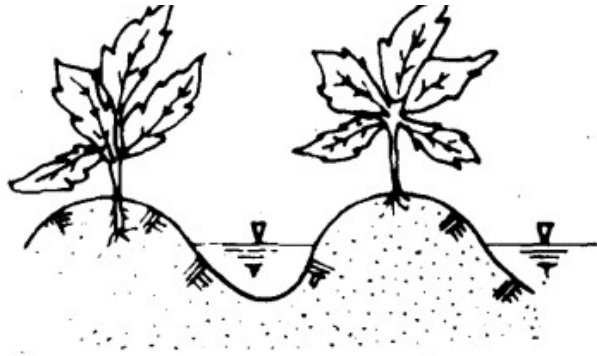

(a) Round shaped furrows

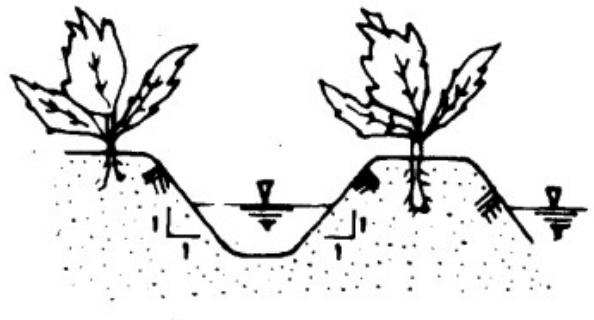

(b) V-Shaped furrows

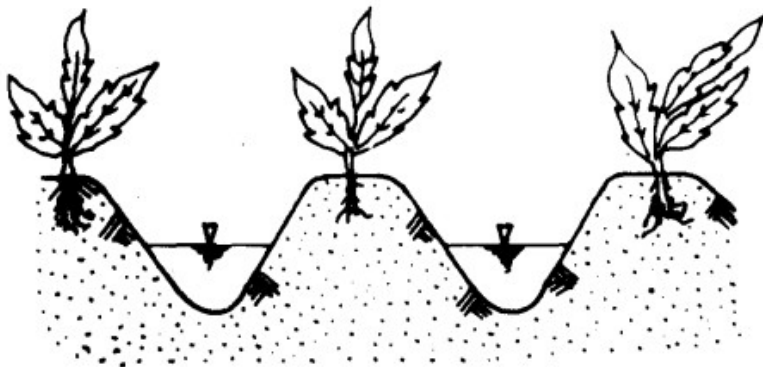

(c) Parabolic furrows

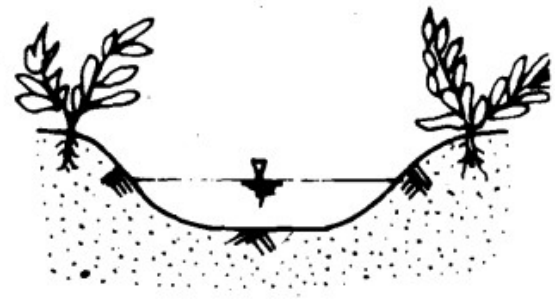

(d) Broad based furrows

## BORDER IRRIGATION

Borders are usually long, uniformly graded strips of land, separated by earth bunds. In contrast to basin irrigation these bunds are not to contain water for ponding but to guide its flow down the field.

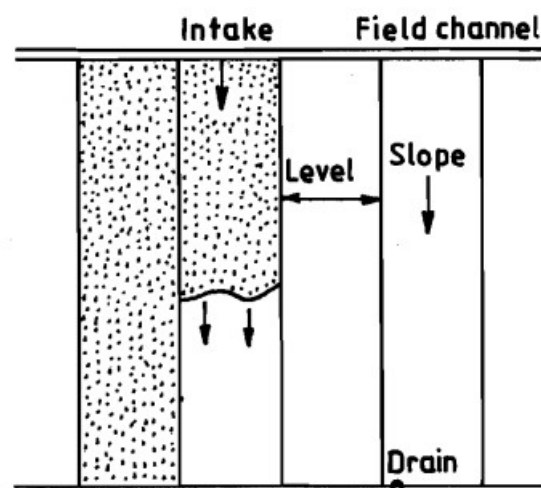

## CHOICE OF METHOD OF IRRIGATION

1. Natural conditions (slope & soil type).
2. Type of crop,
3. Level of technology that is available,
4. Previous experience with the practice of irrigation and
5. Required labour inputs.

### Irrigation scheduling

Irrigation scheduling is the process used by irrigation system managers to determine the correct frequency and duration of watering.

### Advantages of Irrigation Scheduling

1. It enables the farmer to schedule water rotation among the various fields to minimize crop water stress and maximize yields.
2. It reduces the farmer's cost of water and labour
3. It lowers fertilizer costs by holding surface runoff
4. It increases net returns by increasing crop yields and crop quality.
5. It minimizes water-logging problems
6. It assists in controlling root zone salinity problems
7. It results in additional returns by using the "saved" water to irrigate non-cash crops

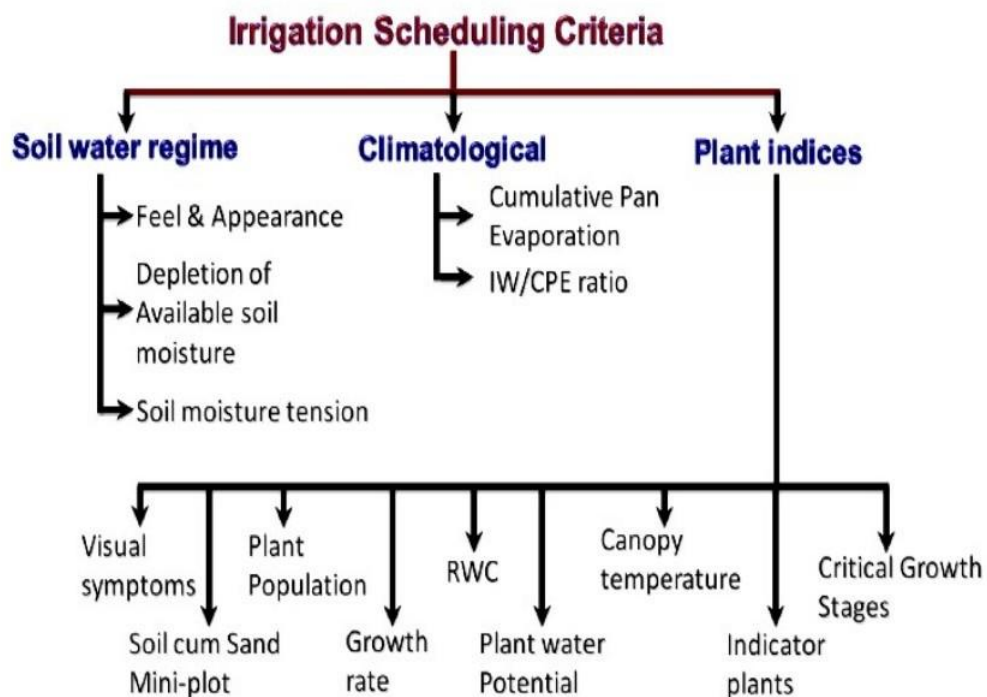

## Soil water regime approach

- In this approach the available soil water held between field capacity and permanent wilting point in the effective crop root zone
- Alternatively soil moisture tension, the force with which the water is held around the soil particles is also sometimes used as a guide for timing irrigations.

## Feel and appearance of soil

- This is one of the oldest and simple methods of determining the soil moisture content.
- It is done by visual observation and feel of the soil by hand.
- The accuracy of judgement improves with experience.

**Table 18.1. Guidelines for judging soil moisture by feel & appearance of soil**

Available soil moisture range	Coarse texture (loamy sand)	Moderately coarse (sandy loamy)	Medium texture (loamy and silt loamy)	Fine texture (clay loamy and silty clay loamy)
Above field capacity	Free water appears when soil is banded in hand	Free water is released with kneading	Free water can be squeezed out	Puddles; free water forms on surface.
At Field capacity (100%)	On squeezing no free water appears on soil, but wet outline of ball is left on hand	Same as for coarse textured soils at field capacity	Same as for coarse textured soils at field capacity	Same as for coarse textured soils at field capacity
75% to 100%	Tends to stick together slightly, may form a very weak ball under pressure	Forms weak ball that breaks easily, does not slick	Forms a ball, very pliable, sticks readily if relatively high in clay	Easily ribbons out between fingers; has a slick feeling
50% to 75%	Appears to be dry, does not form a ball under pressure	Forms a ball under pressure but seldom holds together	Forms a ball under pressure; somewhat plastic, slicks slightly under pressure	Forms a ball; ribbons out between thumb and forefinger
25% to 50%	As above, but ball is formed by squeezing very firmly	Appears to be dry, do not form a ball unless squeezed very firmly	Somewhat crumbly but holds together with pressure	Somewhat pliable, forms a ball under pressure
0 to 25%	Dry, loose & single grained, flows through fingers.	Dry and loose, flows through fingers	Powdery dry, sometimes slightly crusted, but breaks down easily into powder.	Hard, baked and cracked, has loose crumbs on surface in some places

## Depletion of the available soil moisture (DASM)

- In this method the permissible depletion level of available soil moisture in the effective crop root zone depth is commonly taken as an index.
- In general, for many crops scheduling irrigation's at 20 –25% DASM in the soil profile was found to be optimum at moisture sensitive stages.
- While at other stages irrigations scheduled at 50% DASM were found optimum.

## Soil moisture tension

- Soil moisture tension a physical property of film water in soil, as monitored by tensiometers at a specified depth in the crop root zone could also be used as an index for scheduling irrigations to field crops.
- Tensiometers are installed in pairs, one in the maximum rooting depth and the other below this zone.
- Whenever critical soil moisture tension is reached the irrigation is commenced.



- While the lower one (tensiometer) is used to terminate the irrigations based on the suction readings in the below soil profile zone.
- It is generally used for irrigating orchards and vegetables in coarse textured soils because most of the available soil moisture is held at lower tensions.

### **Climatological Approach**

The potential rate of water loss from a crop is primarily a function of evaporative demand of the atmosphere. In this method the water loss expressed in terms of either potential evapotranspiration (PET) or cumulative pan evaporation (CPE)

**Different climatological approaches are described below:**

#### **Potential evapotranspiration (PET)**

Penmen (1948) introduced the concept of PET

It is defined as “the amount of water transpired in a unit time by short green crop of uniform height, completely covering the ground and never short of water”.

**PET can be estimated by several techniques viz.,**

1. Lysimetric methods
2. Energy balance
3. Aerodynamic approach
4. Combination of energy balance and empirical formulae etc.

### **Plant Indices Approach**

#### **Visual plant symptoms**

- In this method the visual signs of plants are used as an index for scheduling irrigations.
- For instance, plant wilting, drooping, curling and rolling of leaves in maize is used as indicators for scheduling irrigation
- Change in foliage colour and leaf angle is used to time irrigations in beans.
- Water stress in some crops leads to appearance of carotenoid (yellow and orange colour) and anthocyanin pigments
- Shortening of internodes in sugarcane and cotton; retardation of stem elongation in grapes;
- Leaf abscission and lack of new growth and redness in terminal growth points of almond

#### **Soil-cum-sand mini-plot technique or profile modification technique**

- Commonly used for scheduling irrigations to crops.
- The principle involved in this technique is to reduce artificially the available water holding capacity of soil profile (i.e., effective root zone depth) in the mini-plot by mixing sand with it.
- When this is done plants growing on the sand mixed plot show wilting symptoms earlier than in the rest of the field.
- An area of 1.0 x 1.0m is selected in the field and a pit of 1.0m depth is excavated.

- About 5% of sand by volume is added to the dug up soil and mixed well.
- The pit is then filled back with the mixture and while filling up every 15 cm layer is well compacted, so that the soil in the pit retains the original bulk density as that of surrounding soil.
- Crop is sown normally and is allowed to grow as usual with the rest of the field.
- As and when the plants in the mini-plot show wilting symptoms it is taken as a warning of impending water need and cropped field is irrigated.

### **Plant population**

- Increase in plant population by 1.5 to 2.0 times that of optimum
- This happens because when more plants are there per unit area, the available water within that zone is depleted rapidly as compared to other area
- This result in drooping or wilting of plants earlier, which can be taken as an indication of water deficits and accordingly irrigations are scheduled to crops.

### **Rate of growth**

- Growth of a plant is dependent on turgor, which in turn is dependent on a favourable soil water balance.
- So fluctuations in the water balance are reflected by parallel fluctuations in the growth rate of expanding organs.
- Stem elongation is markedly reduced when the available soil moisture level approaches the critical level, but accelerates again after irrigation.

### **Canopy temperatureIndicator plants**

- In wheat, scheduling irrigations on the basis of wilting symptoms in maize and sunflower gave the highest grain yields.

### **Critical growth stages**

- The crop plants in their life cycle pass through various phases of growth, some of which are critical for water supply.
- The most critical stage of crop growth is the one at which a high degree of water stress would cause maximum loss in yield.

### **Irrigation Efficiencies**

- Efficiency is the ratio of the water output to the water input, and is usually expressed as percentage.
- Input minus output is nothing but losses, and hence, if Losses are more, output is less and, therefore, efficiency is less. Hence, efficiency is inversely proportional to the losses.
- Water is lost in irrigation during various processes and, therefore, there are different kinds of irrigation efficiencies, as given below
  - Efficiency of Water-conveyance

- Efficiency of Water Application
- Efficiency of Water Use
- Efficiency of water storage
- Water Distribution Efficiency

### **Efficiency of Water-conveyance ( $\eta_c$ )**

• It is the ratio of the water delivered into the fields from the outlet point of the channel, to the water entering into the channel at its starting point. It may be represented by  $\eta_c$ . It takes the conveyance or transit losses into consideration.

$$\eta_c = (W_f/W_r) \times 100$$

Where

- $\eta_c$  = Water conveyance efficiency,
- $W_f$  = Water delivered to the irrigated plot at field supply Channel,
- $W_r$  = Water diverted from the source ( river or reservoir )

### **Efficiency of Water Application ( $\eta_a$ )**

• It is ratio of water stored into the root zone of the crop to the quantity of water delivered at the field (Farm).

$$\eta_a = W_s/W_f \times 100$$

Where,

- $\eta_a$  = Water application efficiency,
- $W_s$  = Water stored at the root zone during the irrigation
- $W_f$  = Water delivered to the farm.

### **Efficiency of Water Use ( $\eta_u$ )**

- It is the ratio of the water beneficially used including leaching water, to the Quantity of water delivered. It may be represented by  $\eta_u$

$$\eta_u = (W_u/W_d) \times 100$$

Where,

- $\eta_u$  = Water use efficiency,
- $W_u$  = Beneficial use of water or consumptive.
- $W_d$  = Water delivered to the field.

### Efficiency of water storage: ( $\eta_s$ )

- The concept of water storage efficiency gives an insight to how completely the required water has been stored in the root zone during irrigation.

$$\eta_s = (W_s/W_n) \times 100$$

Where,

- $\eta_s$  = Water storage efficiency,
- $W_s$  = water stored in the root zone during irrigation.
- $W_n$  = Water need in the root zone prior to irrigation.

### Water Distribution Efficiency ( $\eta_d$ )

Water distribution efficiency evaluates the degree to which water is uniformly distributed throughout the root zone. Uneven distribution has many undesirable results. The more uniformly the water is distributed, the better will be crop response.

$$\eta_d = 100 (1 - y/d)$$

Where,

- $\eta_d$  = Water distribution efficiency,
- $y$  = avg numerical deviation in depth of water stored from avg depth stored in the root zone during irrigation
- $d$  = Avg depth of water stored during irrigation..

### Consumptive use Efficiency ( $\eta_{cu}$ )

It is the ratio of consumptive use of water to the water depleted from the root zone.

$$\eta_{cu} = (W_{cu}/W_d) \times 100$$

Where,

- $\eta_{cu}$  = Consumptive use efficiency,
- $W_{cu}$  = Nominal consumptive use of water
- $W_d$  = Net amount of water depleted from the root zone soil.

\*\*\*\*\*

## UNIT -3

### DIVERSION AND IMPOUNDING STRUCTURES

Types of Impounding structures - Gravity dam – Forces on a dam -Design of Gravity dams; Earth dams, Arch dams- Diversion Head works - Weirs and Barrages.

#### Impounding structure

- Impounding structure or dam means a man-made device structure, whether a dam across a watercourse or other structure outside a watercourse, used or to be used to retain or store waters or other materials.
- The term includes: (i) all dams that are 25 feet or greater in height and that create an impoundment capacity of 15 acre-feet or greater, and (ii) all dams that are six feet or greater in height and that create an impoundment capacity of 50 acre-feet or greater.

#### Diversion headwork.

- Any hydraulic structure, which supplies water to the off-taking canal, is called a headwork.
- A diversion headwork serves to divert the required supply in to the canal from the river.

#### The purposes of diversion headwork.

1. It raises the water level in the river so that the commanded area can be increased.
2. It regulates the intake of water in to the canal.
3. It controls the silt entry in to the canal.
4. It reduces fluctuations in the level of supply in the river.
5. It stores water for tiding over small periods of short supplies.

#### Weir

The weir is a solid obstruction put across the river to raise its water level and divert the water in to the canal. If a weir also stores water for tiding over small periods of short supplies, it is called a storage weir.

#### The component parts of diversion headwork

- Weir or barrage
- Divide wall or divide groyne
- Fish ladder
- Head sluice or canal head regulator
- Canal off-takes
- Flood banks
- River training works.

#### Dam

A dam is a hydraulic structure constructed across a river to store the supply for a longer duration and release it through designed outlets.

## **Types of Dams**

### **Based on Materials of Construction**

- Rigid.
- Non-Rigid.

### **Based on Structural Behaviour**

- Gravity Dam.
- Arch Dam.
- Buttress Dam.
- Embankment Dam.

### **Based on Functions**

- Storage Dam.
- Detention Dam.
- Diversion Dam.
- Coffer dam.

### **Based on Hydraulic Behaviour**

- Over Flow Dam.
- Non Over Flow Dam.

### **General Types**

- Solid gravity dam (masonry, concrete, steel and timber)
- Arch dams
- Buttress dams
- Earth dams
- Rockfill dams
- Combination of rockfill and earth dams

### **Gravity dam**

- A gravity dam is a structure so proportioned that its own weight resists the forces exerted upon it. It requires little maintenance and it is most commonly used.
- A Gravity dam has been defined as a “structure which is designed in such a way that its own weight resist the external forces”.
- This type of a structure is most durable and solid and requires very less maintenance.
- Such dams are constructed of masonry or Concrete.
- However, concrete gravity dams are preferred these days and mostly constructed.
- The line of the upstream face or the line of the crown of the dam if the upstream face is sloping, is taken as the reference line for layout purpose etc. and is known as the Base line

of the dam or the “Axis of The Dam” When suitable conditions are available such dams can be constructed up to great heights.

### The different components of a solid gravity dam are

- Crest.
- Free Board.
- Heel.
- Toe.
- Sluice Way.
- Drainage Gallery.

### Typical cross section of gravity Dam:

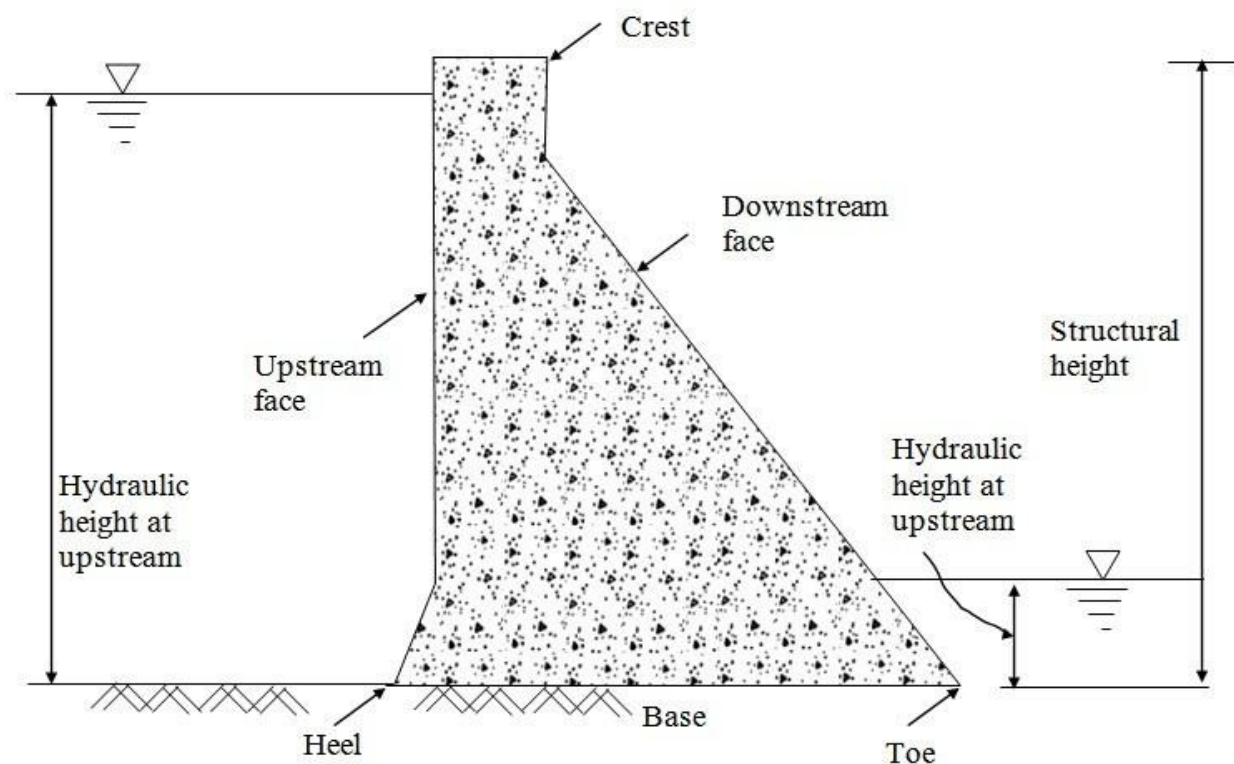
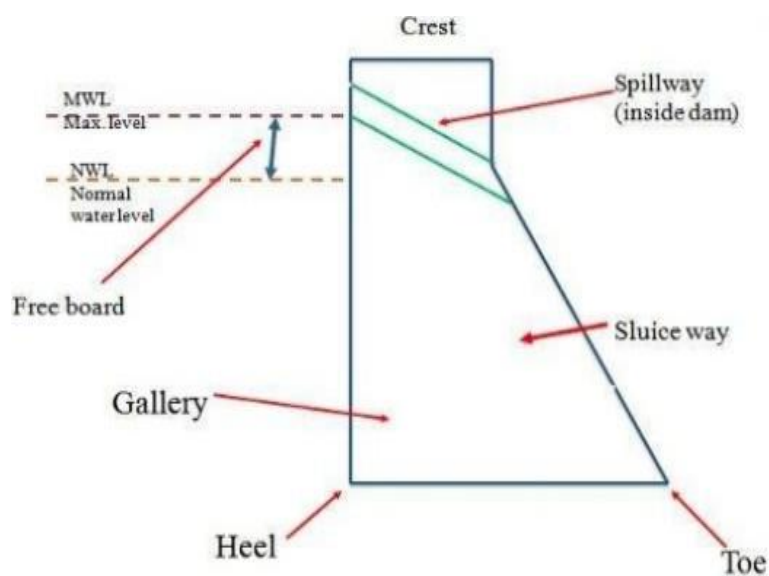

**Heel:** contact with the ground on the upstream side

**Toe:** contact on the downstream side

**Abutment:** Sides of the valley on which the structure of the dam rest

**Galleries:** small rooms like structure left within the dam for checking operations.

**Diversion tunnel:** Tunnels are constructed for diverting water before the construction of dam. This helps in keeping the river bed dry.

**Spillways:** It is the arrangement near the top to release the excess water of the reservoir to downstream side

**Sluice way:** An opening in the dam near the ground level, which is used to clear the silt accumulation in the reservoir side.

### **Forces Acting on Gravity Dam**

The Various external forces acting on Gravity dam may be:

- Water Pressure
- Uplift Pressure
- Pressure due to Earthquake forces
- Silt Pressure
- Wave Pressure
- Ice Pressure
- The stabilizing force is the weight of the dam itself

### **Self weight of the Dam**

Self weight of a gravity dam is main stabilizing force which counter balances all the external forces acting on it.

For construction of gravity dams the specific weight of concrete & stone masonry shouldn't be less than  $2400 \text{ kg/m}^3$  &  $2300 \text{ kg/m}^3$  respectively.

The self weight of the gravity dam acts through the centre of gravity of the.

Its calculated by the following formula –  $W = \gamma_m \times Volume$

Where  $\gamma_m$  is the specific weight of the dam's material.

### **Water pressure**

- Water pressure on the upstream side is the main destabilizing force in gravity dam.
- Downstream side may also have water pressure.
- Though downstream water pressure produces counter overturning moment, its magnitude is much smaller as compared to the upstream water pressure and therefore generally not considered in stability analysis.



- Water Pressure is the most major external force acting on a gravity dam.
- On upstream face pressure exerted by water is stored upto the full reservoir level. The upstream face may either be vertical or inclined.
- On downstream face the pressure is exerted by tail water. The downstream face is always inclined. It is calculated by the following formula –  $P = \frac{1}{2} \gamma_w x h^2$

Where  $\gamma_w$  is the unit weight of water & h is the height of water.

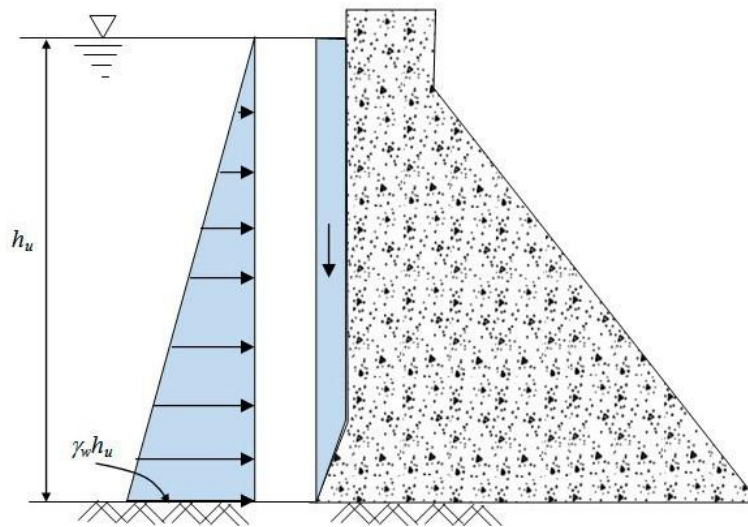

### Uplift water pressure

- The uplift pressure is the upward pressure of water at the base of the dam as shown in Figure 29.3. It also exists within any cracks in the dam.
- The water stored on the upstream side of the dam has a tendency to seep through the soil below foundation.
- While seeping, the water exerts a uplift force on the base of the dam depending upon the head of water.
- This uplift pressure reduces the self weight of the dam.
- To reduce the uplift pressure, drainage galleries are provided on the base of the dams.
- It is calculated by the following formula –  $U = \frac{1}{2} \gamma_w x h x B$

Where 'B' is the width of the base of the dam.

### Wave Pressure

When very high wind flows over the water surface of the reservoir, waves are formed which exert pressure on the upstream part of the dam.

The magnitude of waves depend upon –

- The velocity of wind.
- Depth of Reservoir.
- Area of Water Surface.

It is calculated by the following formula -  $P_v = 2.4 \gamma_w x h_w$

Where 'h<sub>w</sub>' is the wave height.

### **WIND PRESSURE :**

- The top exposed portion on the dam is small & hence the wind pressure on this portion of dam is negligible.
- But still an allowance should be made for the wind pressure at the rate of about 150 kg/m<sup>2</sup> for the exposed surface area of the upstream & downstream faces.

### **SEISMIC FORCES :**

- Dams are subjected to vibration during earthquakes.
- Vibration affects both the body of the dam as well as the water in the reservoir behind the dam.
- The most danger effect occurs when the vibration is perpendicular to the face of the dam.
- Body Forces: Body force acts horizontally at the center of gravity and is calculated as:  
$$P_{em} = a \times W$$
- Water Force: Water vibration produces a force on the dam acting horizontally & calculated by:  
$$P_{ew} = \frac{2}{3} C_e a h^2$$

### **ELEMENTRY PROFILE**

- When water is stored against any vertical face, then it exerts pressure perpendicular to the face which is zero at top & maximum at bottom.
- The required top thickness is thus zero & bottom thickness is maximum forming a right angled triangle with the apex at top, one face vertical & some base width.
- Two conditions should be satisfied to achieve stability
  - **When empty** - The external force is zero & its self weight passes through C.G. of the triangle.
  - **When Full** - The resultant force should pass through the extreme right end of the middlethird.

The limiting condition is - 
$$h = \frac{\sigma_c}{\gamma(1+S)}$$

- where,  $\sigma_c$  = allowable compressive stress

### **Practical Profile**

- Various parameters in fixing the parameters of the dam section are,
- Free Board - IS 6512, 1972 specifies that the free board will be 1.5 times the wave height above normal pool level.
- Top Width - The top width of the dam is generally fixed according to requirements of the roadway to be provided. The most economical top width of the dam is 14 % of its height.

- Base Width – The base width of the dam shall be safe against overturning, sliding & no tension in dam body.

For elementary profile –

- When uplift is considered,  $B = \frac{h}{\sqrt{S}}$
- When uplift isn't considered  $B = \frac{h}{\sqrt{S-1}}$

### Low Gravity Dam

- A low gravity dam is designed on the basis of elementary profile, where the resultant force passes through the middle-third of its base.
- The principal stress is given by  $\sigma = \gamma H (S - C + 1)$  Where,  $\sigma$ =principal stress,  $\gamma$ =unit weight,  $S$ =Specific Gravity and  $C$ =A constant.
- The principal stress varies with 'H' as all other terms are constant. To avoid failure of the dam the value of ' $\sigma$ ' shouldn't exceed allowable working stress( $f$ ).  $F = \gamma H (S - C + 1)$

### High Gravity Dam

- The high gravity is a complicated structure, where the resultant force may pass through a point outside the middle-third of the base.
- The section of the dam is modified by providing extra slope on the upstream and downstream side.
- The condition for the high gravity dam are  $H > \frac{f}{w(S+1)}$  – Where,  $f$ =allowable working stress.

### Failure of Gravity Dam

Failure of gravity dams are caused due to,

- Sliding – It may take place on a horizontal joint above formation, on the foundation. Sliding takes place when total horizontal forces are greater than the combined shearing resistance of the joint and the static friction induced by total vertical forces.
- Overturning – A dam fails in overturning when total horizontal forces acting on the dam section are quite great in comparison with total vertical forces. In such cases the resultant of two passes outside the limits of the dam.
- Dam may fail when tension is produced in the concrete.
- Dam may fail in crushing.

### Precautions against Failure

- To prevent overturning, the resultant of all forces acting on the dam should remain within the middle-third of the base width of the dam.
- In the dam, the sliding should be fully resisted when the condition for no sliding exists in the dam section.

- In the dam section, the compressive stresses of concrete or masonry should not exceed the permissible working stress to avoid failure due to crushing.
- There should be no tension in the dam section to avoid the formation of cracks.
- The factor of safety should be maintained between 4 to 5.

### Temperature Control

During setting of concrete heat of hydration is evolved producing internal temperature stresses resulting in development of internal cracks can get formed.

To control the temperature the following steps may be taken

1. Low heat cement may be used in concrete.
2. The water & coarse aggregates should be cooled down to 5°C by suitable means before mixing.
3. During laying the height of concrete blocks should not be more than 1.5 m. It helps radiate heat to the atmosphere more quickly.
4. The water is cooled by crushed ice before using it for the curing purpose.

### Advantages

1. Gravity dams are more suitable in narrow valleys.
2. Maintenance cost is lower
3. Failure of these dams is not very sudden.
4. Gravity dams may be built to any height.
5. Loss of water by seepage in gravity dams is less

### Disadvantages

1. Initial cost for construction of gravity dams is very higher.
2. Gravity dams of greater height can only be constructed on sound rock foundations.
3. Require skill labour for construction.
4. Design of gravity dams is very complicated.

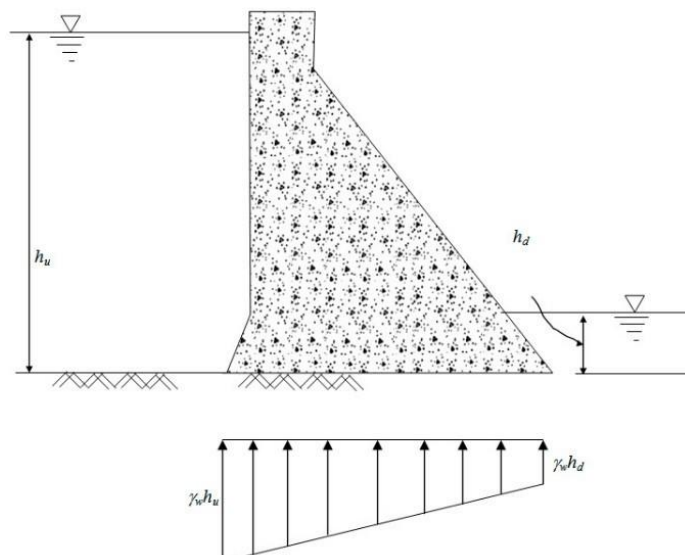

## General Requirement for Stability

A gravity dam may fail in the following modes,

- Overturning
- Sliding
- Compression
- Tension

Therefore, the requirements for stability are,

- The dam should be safe against overturning.
- The dam should be safe against sliding.
- The induced stresses (either tension or compression) in the dam or in the foundation should not exceed the permissible value.

## DESIGN OF GRAVITY DAM

**Example 19.2.** Fig. 19.20 (a) shows the section of a gravity dam built of concrete. Examine the stability of this section at the base.

The earthquake forces may be taken as equivalent to 0.1 g for horizontal forces and 0.05 g for vertical forces. The uplift may be taken as equal to the hydrostatic pressure at the either ends and is considered to act over 60% of the area of the section.

A tail water depth of 6 m is assumed to be present when the reservoir is full and there is no tail water when the reservoir is empty.

Also indicate the values of various kinds of stresses that are developed at heel and toe. Assume the unit wt. of concrete as  $24 \text{ kN/m}^3$ ; and unit wt. of water =  $10 \text{ kN/m}^3$ .

**Solution.** The stability analysis shall be carried out for both the cases, i.e. (1) Reservoir Empty, and (2) Reservoir Full.

**Case (I) Reservoir Empty.** Consider 1 m length of the dam.

When the reservoir is empty, the various forces are worked out in Table 19.2 (a) with reference to Fig. 19.20 (b). Horizontal earthquake forces acting towards upstream are considered. Stability is examined for two sub-cases, i.e. (a) When vertical earthquake

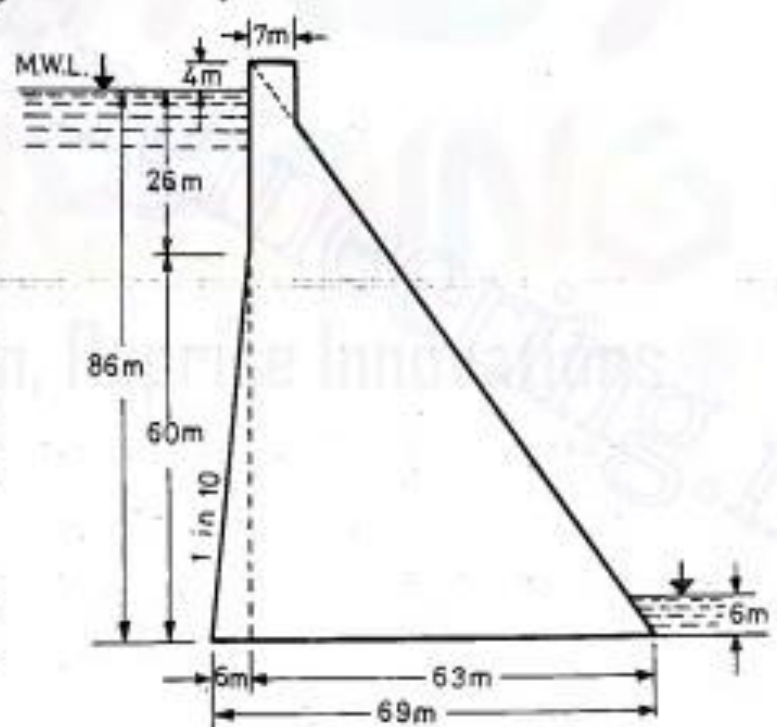

Fig. 19.20 (a)

forces are additive to the weight of the dam ; (b). When vertical earthquake forces are subtractive to the dam weight.

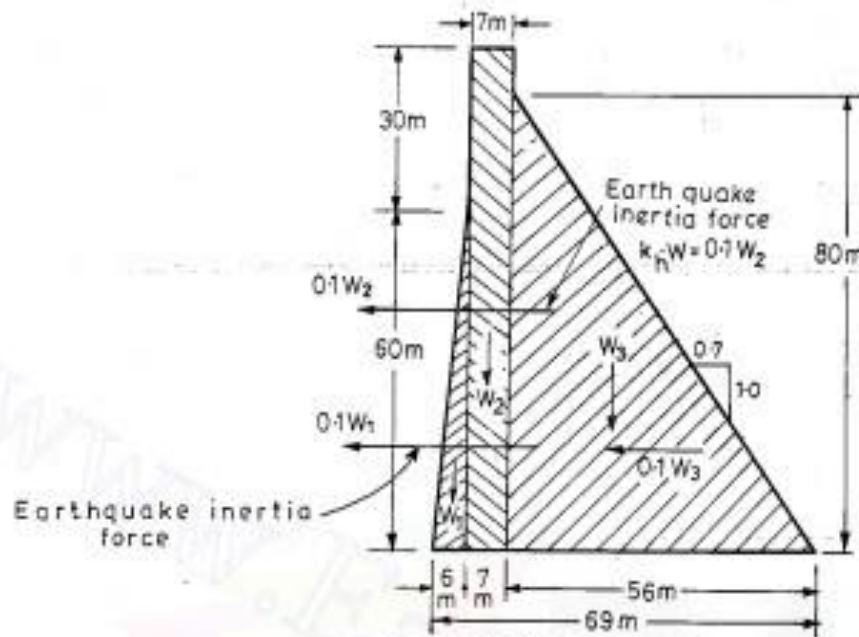

Fig. 19.20 (b). Reservoir empty case.

Table 19.2 (a)

Name of the force	Designation if any	Magnitude of force in kN.		Lever arm m	Moments about the toe anti-clockwise (+ve) in kN.m.
		Vertical	Horizontal		
Downward wt. of dam	$W_1$	(+) $\frac{1}{2} \times 6 \times 60 \times 24 = 4,320$		65.0	(+) 2,80,400
	$W_2$	(+) $7 \times 90 \times 24 = 15,110$		59.5	(+) 8,99,000
	$W_3$	(+) $\frac{1}{2} \times 56 \times 80 \times 24 = 53,700$		37.33	(+) 20,00,000
		$\Sigma V_1 = 73,130$			$\Sigma M_1 = (+) 31,79,400$
Horizontal earthquake forces	$P_{W1}$		$0.1 W_1 = 0.1 \times 4320 = 432$	20.0	(+) 8640
	$P_{W2}$		$0.1 W_2 = 0.1 \times 15,110 = 1511$	45.0	(+) 68,000
	$P_{W3}$		$0.1 W_3 = 0.1 \times 53,700 = 5370$	26.67	(+) 1,43,200
			$\Sigma H = 7313$		$\Sigma M_2 = 2,19,840$
Vertical earthquake forces		$\Sigma V_2 = 0.05 \times \Sigma V_1 = 0.05 \times 73130 = 3,657$			$\Sigma M_2 = 0.05 \times \Sigma M_1 = 0.05 \times 31,79,400 = 1,58,970$

Case (I). (a) Reservoir empty and vertical earthquake forces are acting downward.

From table 19.2 (a), we have  $\Sigma M = \Sigma M_1 + \Sigma M_2 + \Sigma M_3$

$$= 31,79,400 + 2,19,840 + 1,58,970 = 35,58,210 \text{ kN} \cdot \text{m}$$

Also,  $\Sigma V = \Sigma V_1 + \Sigma V_2 = 73,130 + 3,657 = 76,787 \text{ kN}$

$$\bar{x} = \frac{\Sigma M}{\Sigma V} = \frac{35,58,210}{76,787} = 47.3 \text{ m}$$

$$e = \frac{B}{2} - \bar{x} = \frac{69}{2} - 46.3 = 34.5 - 46.3 = -11.8 \text{ m} > \frac{B}{6}, \text{ i.e. } 11.5 \text{ m.}$$

Resultant acts near the heel and slight tension will develop at toe.

$$P_{\max/\min} = \frac{\Sigma V}{B} \left[ 1 \pm \frac{6e}{B} \right]$$

$$\therefore P_{\max/\min} = \frac{76,787}{69} \left[ 1 \pm \frac{6 \times 11.8}{69} \right] = 1114 [1 \pm 1.026]$$

$$p_v \text{ at heel} = 1114 \times 2.026 = 2260 \text{ kN/m}^2; \text{ which is } \leq 3000 \text{ (safe)}$$

$$p_v \text{ at toe} = 1114 \times (-0.026) = -29 \text{ kN/m}^2; \text{ which is } < 420 \text{ (safe)}$$

Average vertical stress

$$= \frac{\Sigma V}{B} = \frac{76787}{69} = 1114 \text{ kN/m}^2; \text{ which is } < 3000 \text{ (safe)}$$

Principal stress at toe,

$$\sigma = p_v \sec^2 \alpha; (\tan \alpha = 0.7)$$

$$= -29 (1 + 0.49) = -29 \times 1.49 = -43 \text{ kN/m}^2; \text{ which is } < 420 \text{ (safe)}$$

Principle stress at heel

$$\sigma_1 = p_{v \cdot (\text{heel})} \sec^2 \phi \quad \text{where } \tan \phi = 0.1$$

$$\text{or } \sec^2 \phi = 1 + \tan^2 \phi = 1 + 0.01 = 1.01.$$

or  $\sigma_1 = 2260 \times 1.01 = 2280 \text{ kN/m}^2; \text{ which is } < 3000 \text{ (safe).}$

Shear stress at toe

$$\tau_{0(\text{toe})} = p_{v(\text{toe})} \tan \alpha$$

$$= -29 \times 0.7 = -20.3 \text{ kN/m}^2; \text{ which is } < 420 \text{ (safe)}$$

Shear stress at heel

$$\tau_{0(\text{heel})} = p_{v \cdot (\text{heel})} \tan \phi$$

$$= 2260 \times 0.1 = 226 \text{ kN/m}^2; \text{ which is } < 3000 \text{ (safe).}$$

**Case I. (b) Reservoir empty and vertical earthquake forces are acting upward.**

Then  $\Sigma V = \Sigma V_1 - \Sigma V_3$

$$= 73,130 - 3657 = 69473 \text{ kN}$$

$$\Sigma M = \Sigma M_1 + \Sigma M_2 - \Sigma M_3$$

$$= 31,79,400 + 2,19,840 - 1,58,970 = 32,40,270 \text{ kN} \cdot \text{m.}$$

$$\bar{x} = \frac{\Sigma M}{\Sigma V} = \frac{32,40,270}{69473} = 46.7 \text{ m.}$$

$$e = \frac{B}{2} - \bar{x} = 34.5 - 46.7 = (-) 12.2 \text{ m} < \frac{B}{6}$$

[ - ve sign shows that resultant lies near the heel and, therefore, tension will develop at toe.]

Average vertical stress

$$= \frac{\Sigma V}{B} = \frac{69,473}{69} = 1004 \text{ kN/m}^2$$

$$p_{max/min} = \frac{\Sigma V}{B} \left[ 1 \pm \frac{6e}{B} \right]$$

$$= \frac{69473}{69} \left[ 1 \pm \frac{6 \times 12.2}{69} \right] = 1004 [1 \pm 1.06]$$

$$p_v \text{ at heel} = 1004 \times 2.06 = 2070 \text{ kN/m}^2 < 3000 \text{ (safe)}$$

$$p_v \text{ at toe} = (-) 1004 \times 0.06 = -60.3 \text{ kN/m}^2 < 420 \text{ (safe)}$$

Principal stress at toe

$$= \sigma = p_{v(toe)} \sec^2 \alpha$$

$$= -60.3 (1 + 0.49) = -60.3 \times 1.49 = 90 \text{ kN/m}^2$$

Shear stress at toe

$$= \tau_0 = p_{v(toe)} \tan \alpha = -60.3 \times 0.7$$

$$= -42.21 \text{ kN/m}^2; \text{ which is } < 420 \text{ (safe)}$$

stresses at heel remain critical in this 1st case.

### Case II. When the reservoir is full

Horizontal earthquake moving towards the reservoir causing upstream acceleration, and thus producing horizontal forces towards downstream is considered, as it is the worst case for this condition. Similarly, a vertical earthquake moving downward and thus, producing forces upward, *i.e.* subtractive to the weight of the dam is considered.

The uplift coefficient  $C$  is taken as equal to 0.6, as given in the equation, and thus uplift pressure diagram as shown in Fig. 19.20 (c), is developed.

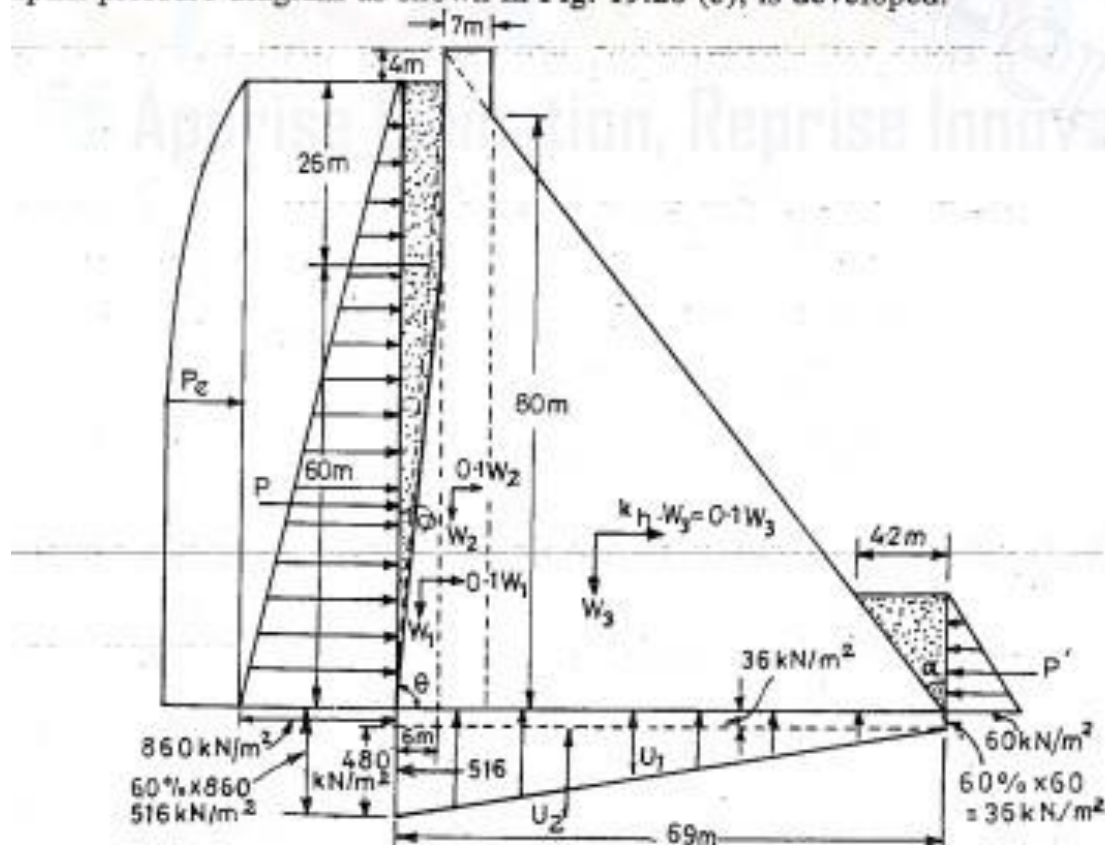

Fig. 19.20 (c) Reservoir full case



The various forces acting in this case are :

- (i) Hydrostatic pressures  $P$  and  $P'$ .
- (ii) Hydrodynamic pressure  $P_e$ . ( $P_e'$  is neglected as it is very small and neglectation is on conservative side.)
- (iii) Uplift forces  $U_1$  and  $U_2$
- (iv) Weight of the dam,  $W_1$ ,  $W_2$  and  $W_3$ .
- (v) Horizontal inertial earthquake forces acting towards downstream, equal to  $0.1 W_1$ ,  $0.1 W_2$  and  $0.1 W_3$  at *c.g.s.* of these weights  $W_1$ ,  $W_2$  and  $W_3$  respectively.
- (vi) A vertical force equal to  $0.05 W$  or  $(0.05 \Sigma V_1)$  acting upward.

### Calculation of $P_e$

$P_e$  and the moment due to this hydrodynamic force is calculated, and then all the forces and their moments are tabulated in Table 19.2 (b).

### Calculation of $P_e$ from Zanger's formulas

$$P_e = 0.726 p_e H \quad \dots(19.3)$$

$$\text{where } p_e = C_m \cdot K_h \cdot \gamma_w \cdot H \quad \dots(19.4)$$

$$\text{and } C_m = 0.735 \frac{\theta}{90^\circ}$$

Since the u/s inclined face is extended for more than half the depth, the overall slope up to the whole height may be taken.

$$\therefore \tan \theta = \frac{86}{6} = 14.33$$

$$\theta = 81.9^\circ$$

$$\therefore C_m = 0.735 \times \frac{81.9^\circ}{90^\circ} = 0.668.$$

$$p_e = 0.668 \times 0.1 \times 10 \times 86 = 57.5$$

$$P_e = 0.726 \times 57.5 \times 86 = 3580 \text{ kN.}$$

$$M_e = 0.412 \cdot P_e \cdot H = 0.412 \times 3580 \times 86 = 1,26,500 \text{ kN.m.}$$

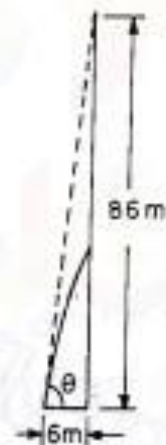

Fig. 19.20 (d)

### Case 2 (a) Reservoir full with all forces including uplift

$$\Sigma M = [31,79,400 + 2,23,380 - 8,47,500 - 1,58,970 - 10,59,730 - 1,26,500 - 2,19,840]$$

$$= 34,02,780 - 24,12,540 = 9,90,240 \text{ kN/m.}$$

$$\Sigma V = 73130 + 3486 - 19030 - 3657 = 53929 \text{ kN}$$

$$\bar{x} = \frac{\Sigma M}{\Sigma V} = \frac{9,90,240}{53,929} = 18.36 \text{ m}$$

$$e = \frac{B}{2} - \bar{x} = 34.5 - 18.36 = 16.14 > \frac{B}{6}$$

The resultant is nearer the toe and tension is developed at the heel.

### Average vertical stress

$$= \frac{\Sigma V}{B} = \frac{53929}{69} = 782 \text{ kN/m}^2.$$

$$P_{\max/\min} = \frac{\Sigma V}{B} \left[ 1 \pm \frac{6e}{B} \right]$$

Table 19.2 (b)

Name of force	Designation if any	Magnitude of force in kN		Lever arm in m	Moments about toe in kN, Anticlockwise (+ve) and clockwise (-ve) in kN.m
		Vertical forces Downward = +ve Upward = -ve	Horizontal forces Towards Upstream = +ve Towards Downstream = -ve		
(1)	(2)	(3)	(4)	(5)	(6)
Weight of Dam	$W_1$	(+) $\frac{1}{2} \times 6 \times 60 \times 1 \times 24 = 4320$		65.0	(+) 2,80,400
	$W_2$	(+) $7 \times 90 \times 1 \times 24 = 15,110$		59.5	(+) 8,99,000
	$W_3$	(+) $\frac{1}{2} \times 56 \times 80 \times 1 \times 24 = 53,700$		37.33	(+) 20,00,000
		$\Sigma V_1 = (+) 73,130$			$\Sigma M_1 = 31,79,400$
Weight of water supported on u/s slope water on d/s slope.	—	(+) $26 \times 6 \times 1 \times 10 = 1560$		66.0	(+) 1,02,800
	—	(+) $\frac{1}{2} \times 60 \times 6 \times 1 \times 10 = 1800$		67.0	(+) 1,10,400
	—	(+) $\frac{1}{2} \times 6 \times 4.2 \times 1 \times 10 = 126$		1.4	(+) 180
		$\Sigma V_2 = (+) 3486$			$\Sigma M_2 = (+) 2,23,380$
Uplift forces	$U_1$	(-) $69 \times 3.6 \times 10 = 2,480$		34.5	(-) 85,500
	$U_2$	(-) $\frac{1}{2} \times 69 \times 48 \times 10 = 16,550$		46.0	(-) 7,62,000
		$\Sigma V_3 = (-) 19,030$			$\Sigma M_3 = (-) 8,47,500$
Upward vertical earthquake forces 0.05 W		$\Sigma V_4 = (-) 0.05 \cdot \Sigma V_1$ = (-) $0.05 \times 73,130$ = (-) 3,657			= (-) $0.05 \cdot \Sigma M_1$ = (-) $0.05 \times 31,79,400$ $\Sigma M_4 = (-) 1,58,970$
Horizontal hydrostatic pressure	$P$		(-) $\frac{1}{2} \times 10 \times 86 \times 86 \times 1$ = (-) 36,980	28.67	(-) 10,60,090
	$P'$		(+) $\frac{1}{2} \times 10 \times 6 \times 6 \times 1 = (+) 180$	2.0	(-) 360
			$\Sigma H_1 = (-) 36,800$		$\Sigma M_5 = (-) 10,59,730$
Horizontal hydro-dynamic pressure	$P_r$		Calculated separately earlier : = (-) 3,580		$\Sigma M_p = (-) 1,26,500$ (calculated separately earlier)
			$\Sigma H_2 = (-) 3,580$		
Horizontal inertia forces due to earthquake	$P_{W_1}$		(-) $0.1 W_1 = (-) 432$	20.0	(-) 8,640
	$P_{W_2}$		(-) $0.1 W_2 = (-) 1,511$	45.0	(-) 68,000
	$P_{W_3}$		(-) $0.1 W_3 = (-) 5,370$	26.67	(-) 1,43,200
			$\Sigma H_3 = (-) 7,313$		$\Sigma M_7 = (-) 2,19,840$

$$\Sigma H = \Sigma H_1 + \Sigma H_2 + \Sigma H_3 = (-) 36,800 - 3580 - 7313 = (-) 47,693$$

$$= \frac{53929}{69} \left[ 1 \pm \frac{6 \times 18.32}{69} \right] = 782 [1 \pm 1.595]$$

$$p_v \text{ (at toe)} = 782 \times 2.595 = 2030 \text{ kN/m}^2; \text{ which is } < 3000 \text{ kN/m}^2 \quad (\therefore \text{ Safe})$$

$$p_v \text{ (at heel)} = -782 \times 0.405$$

$$= -316.7 \text{ kN/m}^2; \text{ which is } < 420 \text{ kN/m}^2 \quad (\therefore \text{ Safe})$$

Since the tensile stress developed is less than the safe allowable value, the dam is safe even when examined with seismic forces, under reservoir full condition.

Principal stress at toe

$$= \sigma = p_v \cdot \sec^2 \alpha - p' \tan^2 \alpha \quad \text{i.e. Eq. (19.17)}$$

$$\text{where } \tan \alpha = 0.7, \quad p' = 60 \text{ kN/m}^2; \quad p_v = 2030 \text{ kN/m}^2$$

$$\sigma = 2030 (1 + \tan^2 \alpha) - p' \tan^2 \alpha$$

$$= 2030 (1 + 0.49) - 60 \times 0.49 = 2030 \times 1.49 - 29$$

$$= 3025 - 29 = 2996 \text{ kN/m}^2; \text{ which is } < 3000 \quad (\text{just Safe})$$

Principal stress at heel is

$$\sigma_1 = p_{v(\text{heel})} \sec^2 \phi - (p + p_e) \tan^2 \phi \quad \text{i.e. Eq. (19.19)}$$

where  $\phi$  is the angle which the upstream face makes with the vertical

$$\tan \phi = 0.1$$

$$\therefore \sigma_1 = -316.7 [1 + (0.1)^2] - (860 + 57.5) (0.1)^2$$

$$= -316.7 \times 1.01 - 917.5 \times 0.01 = -319.9 - 9.2$$

$$= -329.1 \text{ kN/m}^2; \text{ which is } < 420 \text{ kN/m}^2 \quad (\text{Hence, safe})$$

Shear stress at toe

$$\tau_{0(\text{toe})} = (p_{v(\text{toe})} - p') \tan \alpha = (2030 - 60) 0.7$$

$$= 1970 \times 0.7 = 1379 \text{ kN/m}^2.$$

Shear Stress at heel

$$\tau_{0(\text{heel})} = -[p_{v(\text{heel})} - (p + p_e)] \tan \phi$$

$$= -[-329.1 - (860 + 57.5)] 0.1$$

$$= -[-329.1 - 917.5] 0.1 = +1246.6 \times 0.1 = 124.7 \text{ kN/m}^2$$

Factor of safety against overturning

$$= \frac{\Sigma M (+)}{\Sigma M (-)} = \frac{34,02,780}{24,12,540} = 1.41; \text{ which is } < 1.5 \quad (\text{Hence, Unsafe})$$

Factor of safety against sliding

$$= \frac{\mu \cdot \Sigma V}{\Sigma H}$$

$$\text{where } \mu = 0.7$$

$$\Sigma V = 53,929$$

$$\Sigma H = \Sigma H_1 + \Sigma H_2 + \Sigma H_3$$

$$= -36800 - 3580 - 7313 = -47,693 \text{ kN}$$

$$\text{Sliding factor} = \frac{0.7 \times 53929}{47693} = 0.79, \text{ which is } < 1 \quad (\text{Hence, Unsafe})$$

Shear friction factor

$$\begin{aligned} \text{S.F.F.} &= \frac{\mu \cdot \Sigma V + B \cdot q}{\Sigma H} \\ &= \frac{0.7 \times 53929 + 69 \times 1400}{47693} \\ &= 2.81 ; \text{ which is less than } 3 \quad (\text{Hence, slightly unsafe}) \end{aligned}$$

### Case 2 (b). Reservoir full, without uplift

Sometimes, values of stresses at toe and heel are worked out when there is no uplift, as the vertical downward forces are maximum in this case. For this case, we shall calculate  $\Sigma M$  and  $\Sigma V$  by ignoring the corresponding values of  $\Sigma V_3$  and  $\Sigma M_3$  caused by uplift.

$$\begin{aligned} \therefore \Sigma M &= \Sigma M_1 + \Sigma M_2 + \Sigma M_4 + \Sigma M_5 + \Sigma M_6 + \Sigma M_7 \\ &= 31,79,400 + 2,23,380 - 1,58,970 - 10,59,730 - 1,26,500 - 2,19,840 \\ &= 34,02,780 - 15,65,040 = 18,37,740 \end{aligned}$$

$$\Sigma V = \Sigma V_1 + \Sigma V_2 + \Sigma V_4 = 73130 + 3486 - 3657 = 72,959 \text{ kN}$$

$$\bar{x} = \frac{\Sigma M}{\Sigma V} = \frac{18,37,740}{72,959} = 25.19 \text{ m}$$

$$e = \frac{B}{2} - \bar{x} = 34.5 - 25.9 = 9.31 \text{ m} > \frac{B}{6} \quad \text{i.e. } \frac{69}{6} = 11.5 \text{ m}$$

Resultant is nearer the toe and no tension is developed anywhere.

$$\begin{aligned} p_{\max/\min} &= \frac{\Sigma V}{B} \left[ 1 \pm \frac{6e}{B} \right] \\ &= \frac{72,959}{69} \left[ 1 \pm \frac{6 \times 9.31}{69} \right] = 1057 [1 \pm 0.81] \end{aligned}$$

$$p_v \text{ at toe} = 1057 \times 1.81 = 1913 \text{ kN/m}^2 < 3000 \quad (\therefore \text{ Safe})$$

$$p_v \text{ at heel} = 1057 \times 0.19 = 201 \text{ kN/m}^2 < 3000 \quad (\therefore \text{ Safe})$$

$$\text{Principal stress at toe} = \sigma = p_v \cdot \sec^2 \alpha - p' \tan^2 \alpha \quad \dots(19.17)$$

$$p' = 60, \tan \alpha = 0.7$$

$$\therefore \sigma = 1913 (1 + 0.49) - 60 \times 0.49 = 1913 \times 1.49 - 29 = 2821 \text{ kN/m}^2 < 3000 \quad (\text{Hence, Unsafe})$$

Principal stress at heel

$$\sigma_1 = p_{v(\text{heel})} \sec^2 \phi - (p + p_e) \tan^2 \phi \quad \dots(19.19)$$

$$\text{where } \tan \phi = 0.1$$

$$\begin{aligned} \therefore \sigma_1 &= 201(1 + 0.01) - (860 + 57.5) \times 0.01 \\ &= 203 - 9 = 194 \text{ kN/m}^2 < 420 \quad (\text{Safe}) \end{aligned}$$

Shear stress at toe

$$\tau_0 = (p_v - p') \tan \alpha \quad \text{i.e. Eq. (19.20)}$$

$$= (1913 - 60) 0.7$$

$$= 1853 \times 0.7 = 1297 \text{ kN/m}^2 < 1400 \quad (\therefore \text{ safe})$$

**Note.** Shear friction factor, etc. are not worked out here as they were more critical in the 1st case, i.e. in 'Reservoir full with uplift' case.

**Conclusion.** The dam is unsafe only in sliding and S.F.F., for which shear key etc. can be provided.

**Example 19.3.** Examine the stability of the dam section given in the previous example, if there are no seismic forces acting on the dam. Also state the magnitude of maximum compressive stress and maximum shear stress that may develop under any conditions of loading in the dam and also state whether tension is developed anywhere or not.

**Solution.** The figures calculated earlier in Table 19.2 (a) and (b) shall be used here.

**Case I. When the reservoir is empty**

$$\Sigma V = \Sigma V_1 \text{ from Table 10.2 (a)} = 73130$$

$$\Sigma M = \Sigma M_1 \text{ from Table 19.2 (b)} = 3179400$$

$$\therefore \bar{x} = \frac{\Sigma M}{\Sigma V} = \frac{3179400}{73130} = 43.4 \text{ m}$$

$$e = \frac{B}{2} - \bar{x} = 34.5 - 43.4 = -8.9 \text{ m}$$

-ve sign means that the resultant is towards left side, i.e. nearer to the heel, and since  $e < \frac{B}{6}$ , no tension is developed

$$p_{\max/\min} = \frac{\Sigma V}{B} \left[ 1 \pm \frac{6e}{B} \right]$$

$$= \frac{73130}{69} \left[ 1 \pm \frac{6 \times 8.9}{69} \right]$$

$$= 1060 [1 \pm 0.774]$$

$$p_v \text{ at heel} = 1060(1 + 0.774) = 1060 \times 1.774 = 1880 \text{ kN/m}^2$$

$$p_v \text{ at toe} = 1060(1 - 0.774) = 1060 \times 0.226 = 239 \text{ kN/m}^2$$

Average vertical stress

$$= \frac{\Sigma V}{B} = \frac{73130}{69} = 1060 \text{ kN/m}^2$$

Principal stress at toe

$$\sigma = p_{v(\text{toe})} \sec^2 \alpha$$

$$= 239(1 + 0.49) = 239 \times 1.49 = 357 \text{ kN/m}^2$$

Principal stress at heel,

$$\sigma = p_{v(\text{heel})} \sec^2 \phi$$

where  $\tan \phi = 0.1$

$$= 1880(1 + 0.01) = 1880 \times 1.01 = 1896 \text{ kN/m}^2$$

Shear stress at toe

$$\tau_0 = p_{v(\text{toe})} \tan \alpha$$

$$= 239 \times 0.7 = 167.3 \text{ kN/m}^2$$

$$= 734 (1 + 0.01) - 860 \times 0.01$$

$$= 742 - 9 = 733 \text{ kN/m}^2$$

*Shear stress at toe*

$$\tau_0 = [p_{v(\text{toe})} - p'] \tan \alpha$$

$$= (1490 - 60) 0.7 = 1430 \times 0.7 = 1001 \text{ kN/m}^2$$

*Shear stress at heel*

$$= - [p_{v(\text{heel})} - p] \tan \phi$$

$$= - [734 - 860] \times 0.7 = 126 \times 0.7 = 88.2 \text{ kN/m}^2$$

**Conclusions.** We find that the dam is safe throughout except that the S.F.F. is equal to 3.72, while generally it should be between 4 to 5. The dam thus remains slightly unsafe in S.F.F. even when the seismic forces are not considered.

*The results of stability analysis are given below :*

The maximum shear stress developed in dam = 1001 kN/m<sup>2</sup>.

Maximum compressive stress developed in dam = 2191 kN/m<sup>2</sup>

No tension is developed anywhere.

Factor of safety against sliding = 1.10

S.F.F. = 3.72

Factor of safety against overturning = 1.78

Ans.

## EARTHEN DAMS

- An earthen embankment is a raised confining structure made from compacted soil.
- The purpose of an earthen embankment is to confine and divert the storm water runoff. It can also be used for increasing infiltration, detention and retention facilities.
- Earthen embankments are generally trapezoidal in shape and most simple and economic in nature. They are mainly built with clay, sand and gravel, hence they are also known as earth fill dams or earthen dams.
- They are constructed where the foundation or the underlying material or rocks are weak to support the masonry dam or where the suitable competent rocks are at greater depth.
- They are relatively smaller in height and broader at the base.

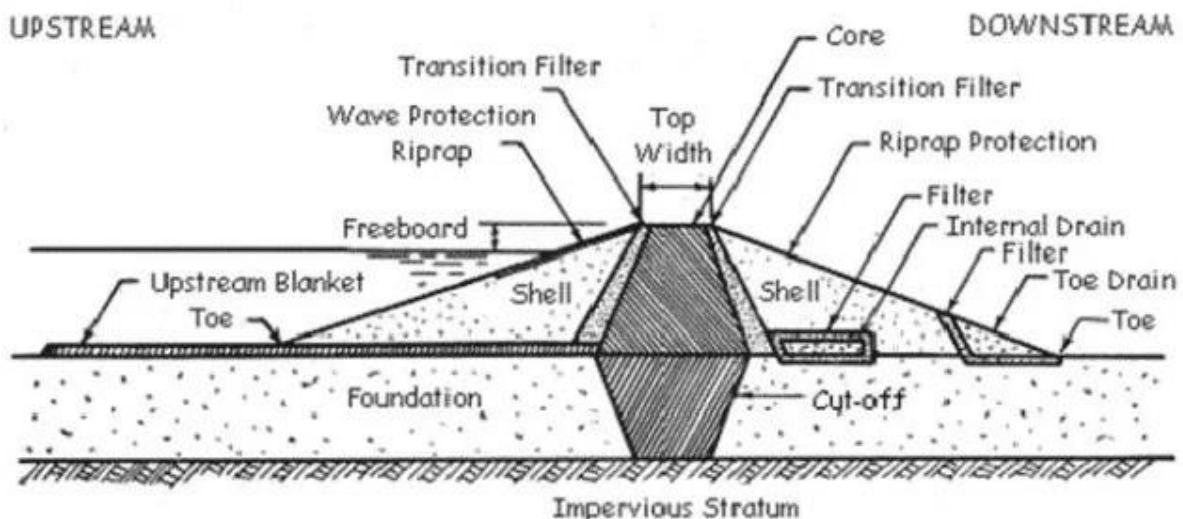

## Components of an Earthen Dam

1. **Shell, Upstream Fill, Downstream Fill or Shoulder:** These components of the earthen dam are constructed with pervious or semi-pervious materials upstream or downstream of the core. The upstream fill is called the upstream shell and the downstream portion is the downstream shell.
2. **Upstream Blanket:** It is a layer of impervious material laid on the upstream side of an earthen dam where the substratum is pervious, to reduce seepage and increase the path of flow. The blanket decreases both the seepage flow and excess pressure on the downstream side of the dam. A natural blanket is a cover of naturally occurring soil material of low permeability.
3. **Drainage Filter:** It is a blanket of pervious material constructed at the foundation to the downstream side of an earthen dam, to permit the discharge of seepage and minimize the possibility of piping failure.
4. **Cutoff Wall or Cutoff:** It is a wall, collar or other structure intended to reduce percolation of water through porous strata. It is provided in or on the foundations.
5. **Riprap:** Broken stones or rock pieces are placed on the slopes of embankment particularly the upstream side for protecting the slope against the action of water, mainly wave action and erosion.
6. **Core Wall, Membrane or Core:** It is a centrally provided fairly impervious wall in the dam. It checks the flow of water through the dam section. It may be of compacted puddled clay, masonry, or concrete built inside the dam.
7. **Toe Drain:** It is a drain constructed at the downstream slope of an earthen dam to collect and drain away the seepage water collected by the drain filters.
8. **Transition Filter:** It is a component of an earthen dam section which is provided with core and consists of an intermediate grade of material placed between the core and the shells to serve as a filter and prevent lateral movement of fine material from the core.

## Advantages

1. Design procedures are straightforward and easy.
2. Local natural materials are used.
3. Comparatively small establishment and equipment are required.
4. Earth fill dams resist settlement and movement better than more rigid structures and can be more suitable for areas where earth movements are common.

## Disadvantages

1. An earthen embankment is easily damaged or destroyed by water flowing on, over or against it. Thus, a spillway and adequate upstream protection are essential for any earthen dam.
2. Designing and constructing adequate spillways is usually the most technically difficult part of any dam building work. Any site with a poor quality spillway should not be used.
3. If it is not adequately compacted during construction, the dam will have weak structure prone to seepage.

4. Earthen dams require continual maintenance to prevent erosion, tree growth, subsidence, animal and insect damage and seepage.

## Types of Earthen Dam

### 1. Based on the method of construction:

#### (a) Rolled Fill Earthen Dams:

- In this type of dams, successive layers of moistened or damp soils are placed one above the other.
- Each layer not exceeding 20 cm in thickness is properly consolidated at optimum moisture content maintained by sprinkling water.
- It is compacted by a mechanical roller and only then the next layer is laid.

#### (b) Hydraulic Fill Earthen Dam:

In this type of dams, the construction, excavation and transportation of the earth are done by hydraulic methods.

Outer edges of the embankments are kept slightly higher than the middle portion of each layer.

During construction, a mixture of excavated materials in slurry condition is pumped and discharged at the edges.

This slurry of excavated materials and water consists of coarse and fine materials. When it is discharged near the outer edges, the coarser materials settle first at the edges, while the finer materials move to the middle and settle there.

Fine particles are deposited in the central portion to form a water tight central core. In this method, compaction is not required.

### 2. Based on the mechanical characteristics of earth materials used in making the section of dam:

#### (a) Homogeneous Earthen Dams:

- It is composed of one kind of material (excluding slope protection).
- The material used must be sufficiently impervious to provide an adequate water barrier, and the slopes must be moderately flat for stability and ease of maintenance

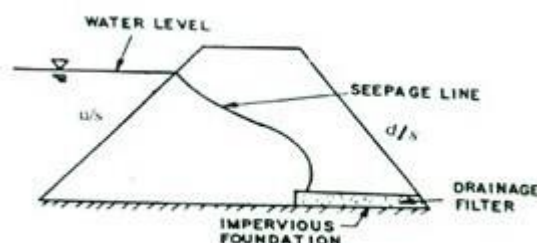

#### (b) Zoned Earthen Dams:

- It contains a central impervious core, surrounded by zones of more pervious material, called shells.
- These pervious zones or shells support and protect the impervious core.



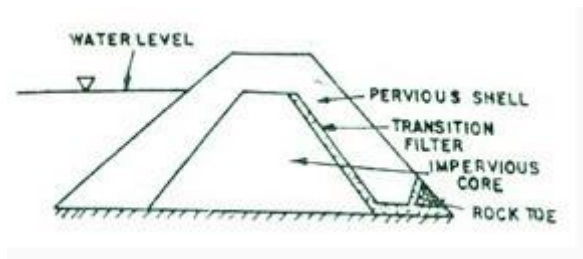

### (c) Diaphragm Earthen Dam:

- This type of dam is a modified form of homogenous dam which is constructed with pervious materials, with a thin impervious diaphragm in the central part to prevent seepage of water.
- The thin impervious diaphragm may be made of impervious clayey soil, cement concrete or masonry or any impervious material.
- The diaphragm can be constructed in the central portion or on the upstream face of the dam.
- The main difference in zoned and diaphragm type of dams depends on the thickness of the impervious core or diaphragm. The thickness of the diaphragm is not more than 10 m.

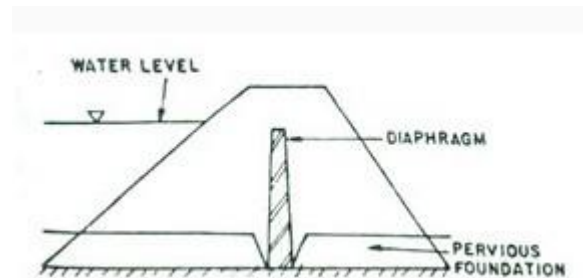

### Design Criteria

Following main design criteria may be laid down for the safety of an earth dam:

1. To prevent hydraulic failures the dam must be so designed that erosion of the embankment is prevented. For this purpose, the following steps should be followed:
  - a) Spillway capacity is sufficient to pass the peak flow.
  - b) Overtopping by wave action at maximum water level is prevented.
  - c) The original height of structure is sufficient to maintain the minimum safe freeboard after settlement has occurred.
  - d) Erosion of the embankment due to wave action and surface runoff does not occur.
  - e) The crest should be wide enough to withstand wave action and earthquake shock.
2. To prevent the failures due to seepage:
  - a) Quantity of seepage water through the dam section and foundation should be limited.
  - b) The seepage line should be well within the downstream face of the dam to prevent sloughing.
  - c) Seepage water through the dam or foundation should not remove any particle or in other words cause piping.

d) There should not be any leakage of water from the upstream to the downstream face. Such leakage may occur through conduits, at joints between earth and concrete sections or through holes made by aquatic animals.

3. To prevent structural failures:

- The upstream and downstream slopes of the embankment should be stable under all loading conditions to which they may be subjected including earthquake.
- The foundation shear stresses should be within the permissible limits of shear strength of the material.

### **Design of Earthen Dam**

The preliminary design of earthen dam is done on the basis of past experiences. For designing purpose several parameters, given below should be considered.

1. Top Width
2. Free Board
3. Settlement Allowance
4. Casing or Outer Shell
5. Cut-off Trench
6. Downstream Drainage System

#### **1. Top Width:**

- Minimum top width (W) should be such that it can enhance the practicability and protect it against the wave action and earth wave shocks.
- Sometimes it is also used for transportation purposes.
- It depends upon the height of the earthen dam and can be calculated as follows:

$$W = \frac{H}{5} + 3 \quad (\text{for very low dam})$$

$$W = 0.55\sqrt{H} + 0.2H \quad (H \leq 30)$$

$$W = 1.65\sqrt[3]{H + 1.5} \quad (H \geq 30)$$

where H = the height of the dam (m), for Indian conditions it should not be less than 6 m.

#### **2. Free board:**

- It is the vertical distance between the top of the dam and the full supply level of the reservoir or the added height.
- It acts as a safety measure for the dam against high flow condition that is waves and runoff from storms greater than the design frequency from overtopping the embankment.
- The Recommended values of free board for different heights of earthen dams, given by U.S.B.R., are given in Table.

### Recommended Values of Free Board given by U.S.B.R.

Nature of spillway	Height of dam	Free board
Free	Any	Minimum 2 m and maximum 3 m over the maximum flood level
Controlled	< 60 m	2.5 m above the top of the gate
Controlled	> 60 m	3 m above the top of the gate

If fetch length or exposure is given then the free board can also be calculated by Hawksley's formula:  $h_w = 0.014 D_m^{0.5}$  where,  $h_w$  = wave height (m);  $D_m$  = fetch or exposure (m).

#### 2. Settlement Allowance:

- It is the result of the settlement of the fill and foundation material resulting in the decrease of dam storage.
- It depends upon the type of fill material and the method and speed of construction.
- It varies from 10% of design height for hand compacted to 5% for machine compacted earthfill.

#### 3. Casing or Outer Shell:

- Its main function is to provide stability and protection to the core.
- Depending upon the upstream and downstream slopes, a recommendation for the casing and outer shell slopes for different types of soils given by Terzaghi is presented in Table

**Recommended Slopes of Earthen Dam (Sources: S.K. Garg, 2008)**

Sl. No.	Types of material	u/s slope	d/s slope
1.	Homogenous well graded material	$2\frac{1}{2}:1$	2:1
2.	Homogenous coarse silt	3:1	$2\frac{1}{2}:1$
3.	Homogenous <u>silty</u> clay or clay		
	a) Height less than 15 m	$2\frac{1}{2}:1$	2:1
	b) Height more than 15 m	3:1	$2\frac{1}{2}:1$
4.	Sand or sand and gravel with clay core	3:1	$2\frac{1}{2}:1$
5.	Sand or sand and gravel with R.C. core wall	$2\frac{1}{2}:1$	2:1

#### Cutoff Trench:

- It is provided to reduce the seepage through the foundation and also to reduce the piping in the dam.

- It should be aligned in a way that its central line should be within the upstream face of the impervious core.
- Its depth should be more than 1 m. Bottom width of cutoff trench (B) is calculated as:  
 $B=h-d$  where h = reservoir head above the ground surface (m); and d = depth of cutoff trench below the ground surface (m).

#### 4. Downstream Drainage System:

- It is performed by providing the filter material in the earthen dam which is more pervious than the rest of the fill material.
- It reduces the pore water pressure thus adding stability to the dam.
- Three types of drains used for this purpose are:
  1. Toe Drains
  2. Horizontal Blanket
  3. Chimney Drains.

#### Causes of Failure

1. Hydraulic Failures 40%
  - a) Piping
  - b) Sloughing
2. Seepage Failures 30%
  - a) Overtopping
  - b) Wave Erosion
  - c) Toe Erosion
  - d) Gullying
3. Structural Failures 30%

- a) Upstream slope failure due to sudden drawdown
- b) Failure by excessive pore pressure
- c) Downstream slope failure by sliding
- d) Failure due to settlement of foundation
- e) Failure by sliding of foundation
- f) Failure by spreading

#### i. Overtopping:

- The dam is overtopped when the volume of incoming flow into the reservoir is more than the actual storage capacity of the reservoir, or the capacity of spillway is not sufficient.
- Sometimes, the faulty operation of spillway also leads to the overtopping problem.
- Similarly, insufficient free board or settlement of foundation as well as embankment also cause the overtopping problem in earthen dam.

## **ii. Wave Erosion:**

- Wave action removes the soil particles from the unprotected part of upstream face of the dam, continuously.
- This is one of the effective factors to cause the hydraulic type failure in earthen dam.

Toe erosion in the earth fill dam, mainly occurs due to following reasons:

### **1. Erosion caused by the tail water; and**

- (ii) Erosion due to cross-currents produced by the storage water, spillway bucket or from the outlet, create the problem of hydraulic failure.
- This type of failure can be overcome by providing a thick layer of stone riprap on the downstream face upto the height of tail water level.

## **iv. Gullying:**

- Development of gully in earthen dam is the result of heavy down pour. Such type of failures can be eliminated by providing a proper size of berm, turf or good drainage system towards down-stream side of the dam.

## **2. Seepage Type Failures:**

Failure of earthen dam due to seepage phenomena may be due to following two reasons:

i. Piping; and

ii. Sloughing.

i. Piping:

The continuous flow of seepage water through the body as well as foundation of the dam is the main reason of piping. It causes catastrophic failures in the earth fill dams.

**The flow of seepage water through the body of earth dam develop following four effects:**

- a) The flow of seepage water generates an erosive force, which tends to dislodge the soil particles from the dam section. The dislodged particles are migrated into the voids of the filter materials, down-stream side; and thus clogged them, as result the drainage system gets failed.
- b) The seepage flow develops differential pore pressure which tends to lift up the soil mass, causing boiling effect in the dam.
- c) Piping is also the result of internal erosion of the soil mass due to seepage flow through the earth dam.
- d) The pore pressure developed in the soil reduces the soil strength, which makes the soil mass weak, as result there is failure of dam due to shear force.

Sometimes, the leakage from earthen dam also generates the piping type failure. Furthermore, it is also observed that, the piping type failure is most prominent in those dams, which are poorly constructed. Generally, this is due to poor compaction surrounding the concrete outlets or other parts of the structure etc.

## **ii. Sloughing:**

- Failure of earthen dam due to sloughing is closely related to the water level in the reservoir.
- In full reservoir condition the downstream toe of the dam becomes fully saturated, which is failure by producing a small slump or miniature slide.
- Under miniature slide the saturated steep face of the dam is dislodged.
- This process is continued till the remaining portion of the dam is being very weak to withstand against pore water pressure.

## **3. Structural Failures:**

- i. Structural failure mainly caused by the following reasons:
- ii. Upstream and downstream slope failures due to formation of excessive pore pressure.
- iii. Upstream failure due to sudden drawdown in the reservoir water level.
- iv. Downstream failure at the time of full reservoir.
- v. Foundation slide.
- vi. Failure of dam due to earthquake.
- vii. Failure of dam due to unprotected side slope.
- viii. Failure due to damage caused by burrowing animals.
- ix. Failure due to damage caused by water soluble materials.

### **i. Upstream and Downstream Slope Failure due to Pore Pressure:**

- Development of pore pressure in the body of earthen dam, is mainly due to poor compressibility of the soil.
- This occurrence is more susceptible, when dam is constructed with relatively impervious compressible soils, in which drainage of seepage water is extremely low, which causes the development of pore pressure in the soil.
- The compressibility of soil is related to the permeability.
- It has been observed that, when permeability of soil is less than  $10^{-6}$  cm/s, then there is no substantial drop in pore pressure in the central part of the dam by the end of construction.
- A pore pressure equal to 140% of total weight of soil develops a very crucial situation regarding dam stability. In this condition the slope of dam is likely to failed.

### **ii. Failure of Upstream Slope due to Sudden Draw down in the Reservoir Water level:**

- Failure of upstream slope due to sudden draw down in reservoir water level is a critical condition.
- During this stage, the hydrostatic pressure acting along the upstream slope is suddenly removed, as result the face of the dam gets slide.
- In this failure the upstream side slope did not get complete failure, because when slide takes place due to sudden draw down in reservoir water level, the pore pressure acting along the

sliding surface is reduced to a large extent. In this way, the tendency to continue the process of sloughing and sliding of upstream face of the dam, is checked.

### **iii. Downstream Slope Slide during Full Reservoir Condition:**

- When the reservoir is in full condition, then there happens maximum percolation/seepage loss through the dam section.
- This results into reduction of stability of the dam, which causes the downstream slope gets collapse.
- In this case, the failure of downstream slope generally takes place in-following two types of slide:

#### **(a) Deep Slide:**

- Deep slide generally takes place in the clay foundations.
- In deep slide the magnitude of free board given to the dam is reduced due to extending of upstream face beyond its edge of the crest.
- In this type of slide the pore pressure does not decrease, and the unstable vertical face tends to slough or slide again and again, until to breach the entire dam.

#### **(b) Shallow Slide:**

- The shallow slide extends in the dam section not more than 2 m in the direction normal to the slope.

### **iv. Failure due to Foundation Slide:**

- This type of failure of earthen dam generally takes place, when foundation is constructed, using fine silt or soft soil materials.
- Sometimes, when soft and weak clayey soil exists under foundation, then dam also tends to get slide.
- Similarly, excess water pressure in confined sand and silt is also developed in the foundation, which causes the failure of dam due to creation of unbalanced condition.

### **v. Failure of Dam due to Earthquake:**

It generally takes place due to following reasons:

1. Earthquake develops cracks in the body of dam; and thus leading to flow of water, which ultimately causes to failure the dam.
2. It compresses the foundation and embankment, both, thereby the total free board provided to the dam gets reduce and thus, increasing the chances of overtopping problem.
3. It shakes the bottom of the reservoir, as result there develop wave action, which causes the problem of failure of dam due to overtopping and wave erosion.
4. It generates an additional force on the face of embankment that can lead to develop shear slide of dam slope.

5. Earthquake is also responsible for sliding the top of dam, which may cause overtopping; and thus damaging the structure.

**vi. Failure of Earthen Dam due to Slope Protection:**

- Generally, slopes are protected by rip-rap or revetment using a layer of gravel or filter blanket.
- When a heavy storm occurs, then water wave beats the dam slope repeatedly above the reservoir level.
- This action of wave produces the following two effects:
- The wave enters the voids of the rip-rap and washout the filter layer from the dam face. This causes the embankment to get expose to the wave action; and
- If rip-rap is not done by heavy rocks, then there is greater chance of their removal by the forces generated from water waves.

**vii. Failure due to Damage Caused by Burrowing:**

- Burrowing develops piping type failure in earthen dam. Generally, the animals like muskats burrow the embankment section, either to make shelter for their living or to make a direct passage for running from one end to another.
- If several muskats involved together to make the hole, then their holes may extremely weaken the dam section.

**viii. Failure due to Water Soluble Materials:**

- Based on several observations on this aspect of failure of earthen dams, it has been found that the leaching of natural water soluble materials such as zypsum etc. from the dam tends to create water leakage problem through the dam section.
- In this condition, the foundation also gets settle down, and thus creates the problem of overtopping and ultimately the dam reaches to the point of its failure.

**DESIGN OF EARTHEN DAM**



**Example 20.4.** An earthen dam made of homogeneous material has the following data :

Level of the top of the dam	= 200.00 m
Level of deepest river bed	= 178.0
H.F.L. of reservoir	= 197.5 m
Width of top of dam	= 4.5 m
Upstream slope	= 3 : 1
Downstream slope	= 2 : 1
Length of the horizontal filter from d/s toe, inwards	= 25 m
Cohesion of soil of dam	= 24 kN/m <sup>2</sup>
Cohesion of soil of foundation	= 54 kN/m <sup>2</sup>
Angle of internal friction of soil in the dam	= 25°
Angle of internal friction of soil in the foundation	= 12°
Dry weight of the soil in the dam	= 18 kN/m <sup>3</sup>
Submerged weight of the soil in the dam	= 12 kN/m <sup>3</sup>
Dry unit weight of the foundation soil	= 18.3 kN/m <sup>3</sup>
Coefficient of permeability of soil in the dam	= 5 × 10 <sup>-6</sup> m/sec.

The foundation soil consists of 8 m thick layer of clay, having negligible coefficient of permeability. Check the stability of the dam and its foundations.

**Solution.**

**(1) Overall stability of the dam section as a whole**

We will consider 1 m length of the dam. The section of the dam and the phreatic line is first of all drawn, as given in example 20.3 and shown in Fig. 20.29 (a). The dam section, etc. is generally drawn on a graph sheet so as to facilitate in measuring the areas above and below the seepage line, if planimeter is not available.

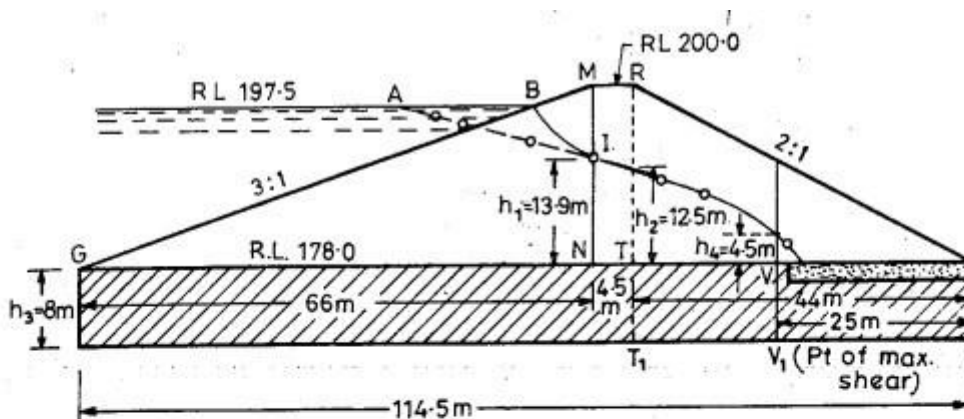

Fig. 20.29 (a)

The total area of dam section =  $(114.5 + 4.5) \frac{22}{2} = 1,409 \text{ sq. m}$

The area above the seepage line is measured and is approximately found to be 380 m<sup>2</sup>. (In the absence of a planimeter, graph can be used).

∴ Area below the seepage line = 1,409 – 380 = 1,029 sq. m

Now

Weight of the dry portion of the dam section

=  $(380 \text{ m}^2 \times 1 \text{ m} \times 18 \text{ kN/m}^3) = 6830 \text{ kN}$ .

Weight of the submerged portion of the dam section

=  $1029 \text{ m}^2 \times 1 \text{ m} \times 12 \text{ kN/m}^3 = 12,350 \text{ kN}$

Total weight of dam (called average weight)

= 6,830 + 12,350 = 19,180 kN

Shear resistance of the dam at the base

$$= C + W \tan \phi$$

where  $C$  = Total cohesive strength of the soil at the base

$$= c \times B \times 1 = (24 \times 114.5 \times 1) \text{ kN}$$

$B$  = Total base width = 114.5 m

$$W \tan \phi = 19,180 \tan 25^\circ$$

$\therefore$  Shear resistance at base,

$$R = 24 \times 114.5 \times 1 + 19180 \tan 25^\circ = 11690 \text{ kN}$$

Horizontal force = Horizontal pressure of water.

$$= P = \frac{1}{2} \gamma_w h^2 = \frac{1}{2} \cdot 9.81 (19.5)^2 = 1865 \text{ kN}$$

Factor of safety against failure due to horizontal shear at base

$$= \frac{11690}{1865} = 6.27 > 1.3 (\therefore \text{ Safe})$$

(2) **Stability of the u/s slope portion of dam (Under sudden drawdown) horizontal shear along the base under the u/s slope of dam**

Draw a vertical through the u/s extremity of the top width of dam [i.e. point  $M$ , Fig. 20.29 (a)] so as to cut the base of the dam at point  $N$ . This vertical  $MN$  cuts the seepage

line at a point, the height of which is measured as  $h_1 = 13.6$  m above the base of the dam.

Horizontal force ( $P_u$ ) acting on the  $\Delta GMN$  is given by equation (20.27) as :

$$P_u = \left[ \frac{\gamma_1 h^2}{2} \tan^2 \left( 45 - \frac{\phi}{2} \right) + \gamma_w \cdot \frac{h_1^2}{2} \right]$$

where  $\gamma_1$  = the weighted density at the centre of triangular shoulder upstream ( $\Delta GMN$ ) and is given by equation (20.28) as :

$$\begin{aligned} \gamma_1 &= \frac{\gamma_{sub} \cdot h_1 + \gamma_{dry} (h - h_1)}{h} \\ &= \frac{12 \times 13.9 + 18 (22.0 - 13.9)}{22.0} \\ &= 14.7 \text{ kN/m}^3 \end{aligned}$$

$$\therefore P_u = \frac{14.7 \times (22.0)^2}{2} \tan^2 \left( 45^\circ - \frac{25^\circ}{2} \right) + 9.81 \times \frac{(13.9)^2}{2} = 2391 \text{ kN}$$

Shear resistance  $R_u$  of the u/s slope portion of dam developed at the base  $GN$  is given by equation (20.29) as :

$$\begin{aligned} R_u &= C + W \tan \phi \\ &= c (B_u \times 1) + (\gamma_{sub} \frac{1}{2} B_u h) \tan \phi ; \text{ neglecting the small dry soil area } BMI, \text{ as it is very small and this neglectation is on a safer side.} \end{aligned}$$

$$B_u = 66 \text{ m}$$

$$\begin{aligned} \therefore R_u &= 24 \times 66 + (12 \cdot \frac{1}{2} \cdot 66 \cdot 22.0) \tan 25^\circ \\ &= 1584 + 4062 = 5646 \text{ kN} \end{aligned}$$

Factor of safety against horizontal shear along base under u/s slope

$$= \frac{R_u}{P_u} = \frac{5646}{2391} = 2.36 > 2.0 \quad (\therefore \text{safe})$$

Horizontal shear stress induced in the u/s slope portion of dam at base.

$$\tau_{av} = \frac{P_u}{B_u \times 1} = \frac{2391}{66} \text{ kN/m}^2 = 36.23 \text{ kN/m}^2$$

$\tau_{max}$  = Maximum shear

$$= 1.4 \tau_{av} = 1.4 \times 36.23 = 50.72 \text{ kN/m}^2$$

The maximum shear is developed at a point  $0.6 B_u$

$$= 0.6 \times 66 = 39.6 \text{ m away from point } G$$

The unit shear resistance developed at this point

$$\begin{aligned} \tau_f &= c + 0.6 \gamma_{sub} \tan \phi \\ &= 24 + 0.6 \times 22.0 \times 12 \tan 25^\circ = 97.9 \text{ kN/m}^2 \end{aligned}$$

$$\therefore \text{F.S.} = \frac{\tau_f}{\tau_{max}} = \frac{97.9}{50.72} = 1.93 > 1 \quad (\therefore \text{safe}).$$

(3) **Stability of d/s portion of dam.** *Horizontal shear along base under the d/s slope of dam.*

Draw a vertical through the d/s extremity of the top width of dam (*i.e.* point *R*) to cut the base at point *T* [Fig. 20.29 (a)]. Let this vertical cut the seepage line in a point, the height of which from the base is measured as  $h_2 = 12.5 \text{ m}$ .

Horizontal force  $P_d$  acting on the portion of downstream dam (*RTS*) during steady seepage is given by equation (20.35) as :

$$P_d = \left[ \frac{\gamma_2 h^2}{2} \tan^2 \left( 45^\circ - \frac{\phi}{2} \right) + \gamma_w \frac{h^2}{2} \right]$$

where  $\gamma_2$  is the weighted density at the centre of the triangular shoulder *RTS* and given by equation (20.36) as :

$$\begin{aligned} \gamma_2 &= \frac{\gamma_{sub} h_2 + \gamma_{dry} (h - h_2)}{h} \\ &= \frac{12 \times 12.5 + 18 \times (22.0 - 12.5)}{22.0} \\ &= 14.6 \text{ kN/m}^3 \end{aligned}$$

$$P_d = \frac{14.6 (22)^2}{2} \tan^2 \left( 45^\circ - \frac{25^\circ}{2} \right) + 9.81 \cdot \frac{(12.5)^2}{2} = 2200 \text{ kN}$$

Shear resistance  $R_d$  of the d/s slope portion of dam developed at base *TS* is given as :

$$R_d = C + W \tan \phi$$

The area  $A_1$  of the dry soil within the  $\Delta RTS$  above the seepage line  $\approx 300$  sq. m (from graph or planimeter).

The total area of the  $\Delta RTS = \frac{1}{2} \times 44 \times 22 = 484 \text{ m}^2$

$\therefore$  Area of submerged soil

$$A_2 = 484 - 300 = 184 \text{ sq. m}$$

$$R_d = cB_d + [\gamma_{dry} A_1 + \gamma_{sub} A_2] \tan \phi$$
$$= 24 \times 44.0 + [18 \times 300 + 12 \times 184] \tan 25^\circ = 4604 \text{ kN.}$$

F.S. against horizontal shear along base under d/s slope

$$= \frac{R_d}{P_d} = \frac{4604}{2200} = 2.09 > 2 (\therefore \text{ Safe})$$

Average shear induced at base

$$= \frac{P_d}{B_d} = \frac{2200}{44} = 50 \text{ kN/m}^2$$

Maximum shear stress induced

$$\tau_{max} = 1.4 \times 50 = 70 \text{ kN/m}^2$$

The maximum shear stress is developed at a point  $0.6 B_d$

$$= 0.6 \times 44 = 26.4 \text{ m away from toe}$$

This unit shear resistance developed at this point

$$\tau_f = c + 0.6h \gamma_{sub} \tan \phi$$

(assuming the entire height as submerged as it will give safer results)

$$= 24 + 0.6 \times 22 \times 12 \tan 25^\circ = 97.9 \text{ kN/m}^2$$

$$\therefore \text{ F.S.} = \frac{\tau_f}{\tau_{max}} = \frac{97.9}{70} = 1.40 > 1 \quad (\therefore \text{ Safe})$$

#### (4) Stability of the foundation soil

Average compressive stress on foundation soil

$$= \frac{\text{Weight of dam}}{\text{Base area on which it acts}}$$

Since the compressive stress is maximum when the entire dam soil is dry, therefore, we will first calculate the dry weight of the dam.

Area of section of dam

$$= 1,409 \text{ sq. m (calculated earlier)}$$

Dry weight of dam section

$$= 18 \times 1,409 = 25,362 \text{ kN}$$

Average compressive stress at base

$$= \frac{25362}{114.5} = 221.5 \text{ kN/m}^2$$

### Shear stress induced at base

The total horizontal shear force ( $P$ ) under the d/s slope of the dam (which is the worst case, i.e. the steepest slope) is given by equation (20.39) as :

$$P = \gamma_{eq} \left[ \frac{(h + h_3)^2 - h_3^2}{2} \right] \left[ \tan^2 \left( 45^\circ - \frac{\phi_1}{2} \right) \right]$$

where  $\gamma_{eq}$  is the equivalent weight of dry soil in foundation and dam

$$\gamma_{eq} = \frac{18h + 18.3 h_3}{h + h_3}$$

[ $\therefore$  Unit wt. of foundation soil of thickness  $h_3 = 18.3 \text{ kN/m}^3$ ]

where  $h = 22 \text{ m}$

$h_3 = 8 \text{ m}$ .

$$\therefore \gamma_{eq} = \frac{18 \times 22 + 18.3 \times 8}{22 + 8} = 18.1 \text{ kN/m}^3$$

$\phi_1$  is given by equation (20.41) as :

$$\gamma_{eq} (h + h_3) \tan \phi_1 = c_f + \gamma_{eq} (h + h_3) \tan \phi_f$$

or  $18.1 (22 + 8) \tan \phi_1 = 54 + 18.1 (22 + 8) \tan 12^\circ$

or  $\tan \phi_1 = 0.312$

or  $\phi_1 = 17.3^\circ$

$$\therefore P = 18.1 \left[ \frac{(22 + 8)^2 - (8)^2}{2} \right] [\tan^2 (45^\circ - 8.65^\circ)]$$

$$= \frac{18.1}{2} [900 - 64] [(0.737)^2] = 4100 \text{ kN}$$

Average shear stress induced at base of d/s slope

$$\tau_{av} = \frac{4100}{44} = 93.2 \text{ kN/m}^2$$

Maximum shear stress induced at  $0.6 \times 44 = 26.4 \text{ m}$  away from the d/s toe inwards at point  $V_1$  is given by

$$= \tau_{max} = 1.4 \times 93.2 = 130.4 \text{ kN/m}^2$$

### Shear resistance of the foundation soil below the d/s slope portion of dam

Unit shear resistance  $\tau_{f_1}$  below the toe at point  $S_1$

$$= [c_f + \gamma_f \times h_3 \tan \phi_f]$$

$$= 54 + 18.3 \times 8 \times \tan 12^\circ$$

$$\therefore = 85.1 \text{ kN/m}^2$$

Unit shear resistance  $\tau_{f_2}$  at point  $T_1$

$$= c_f + \gamma_3 (h + h_3) \tan \phi_f$$

where  $\gamma_3 = \frac{\gamma_{sub \text{ for dam}} \times h_2 + \gamma_{dry \text{ for dam}} \times (h - h_2) + \gamma_f h_3}{h + h_3}$

$$= \frac{12 \times 12.5 + 18 \times 9.5 + 18.3 \times 8}{30} = 15.6 \text{ kN/m}^3$$

$$\therefore \tau_{f_2} = 54 + 15.6 (22 + 8) \times \tan 12^\circ = 153.5 \text{ kN/m}^2$$

The average unit shear resistance developed at foundation level in a length equal to  $T_1 S_1 = 44$  m, is given by

$$\tau_f = \frac{\tau_{f1} + \tau_{f2}}{2} = \frac{85.1 + 153.5}{2} = 119.3 \text{ kN/m}^2$$

Over all F.S. against shear

$$= \frac{\tau_f}{\tau_{av}} = \frac{119.3}{93.2} = 1.28 < 1.5 \quad \text{(Hence, unsafe)}$$

The foundation soil is thus weaker to carry the load and hence the d/s slope will have to be flattened.

Shear resistance at the point of maximum shear, i.e. at point  $V_1$  is given as :

$$(\tau_f)_{max} = c_f + (0.6h + h_3) \gamma_4 \tan \phi_f$$

$$\gamma_4 = \frac{12 \times 4.5 + 18(0.6 \times 22 - 4.5) + 18.3 \times 8}{0.6 \times 22 + 8} = 16.8 \text{ kN/m}^3$$

$$(\tau_f)_{max} = 54 + [0.6 \times 22 + 8] 16.8 \tan 12^\circ = 129.8 \text{ kN/m}^2$$

$$\text{F.S.} = \frac{[\tau_f]_{max}}{\tau_{max}} = \frac{129.8}{130.4} = 0.995 < 1.0 \quad \text{(Hence, Unsafe)}$$

The foundation shear and F.S. can also be calculated below the u/s portion of dam soil, in the same manner as has been done for d/s slope portion, if required.

## DESIGN OF ARCH DAM

- Dam, Barrage and a weir structure is a natural or man-made obstruction or barrier build across a river in-between the two ends of the river to raise the water, called head of the structure as well produce a massive storage.
- A barrage is built to divert this river water into the nearby link canals by regulating head for irrigation purpose.
- A dam is built to utilize the head for power generation and for storage.
- Dams are classified in different categories based on the type of material used; shape of the core structure; purpose of the project etc.
- Arch dam, as the name implies, is a curved obstruction from the upstream side singly spanned that mainly carries the load of the impounded water through arch action as well as cantilever action.
- Arch dams through arch action transfers portion of the load of the water thrust horizontally to the side abutments and the other portion of that load is transferred to the dam foundation vertically by cantilever action.
- In the arch action, hydrostatic pressure / force of water press against the face of the arch which in return compresses and strengthens the matrix of the arch dam structure.
- Arch Dams throughout the world are mostly made of concrete (either conventional concrete or roller compacted concrete); however, in the past some are also made with rubble and stone masonry.
- Let us now discuss in detail about the distribution of the load by an arch dam, which is briefly explained above;

- Let us consider an arch dam made up of two connected components one is series of arches and other is series of vertical cantilevers; as shown:-

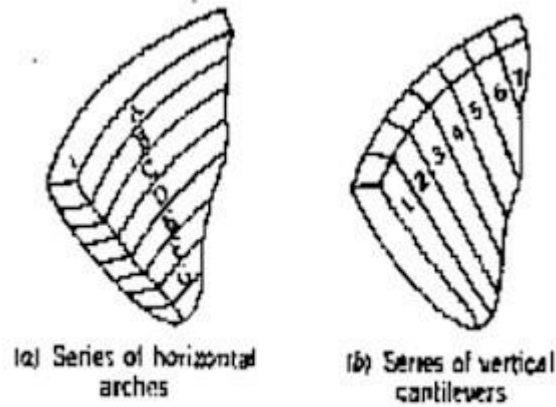

*Series of horizontal arches and vertical cantilevers*

- The load caused due to thrust of impounded water in the arch dam is transferred to the abutments rested on solid / stable rocky side walls of the valley / canyon.
- Thus the load on the cantilever wall is reduced in arch dam as compared to that of the gravity dam. It is one of the major benefit due to which arch dam is considered economic.

#### **Situations When Arch Dam is a must to use**

- Arch dam is proved most economical and efficient when the width of the canyon or valley to be spanned on the river is least.
- As a major share of the impounding water thrust is taken by abutment walls resting on the sides of the canyon, thus these must be stable, strong and firm.
- Arch dam can be used most economically on a terrain where width of the valley is less than 6 times of its height or in other words  $B/h$  ratio is less than 6.
- If the area is remote such that the naturally available material are not enough to provide sufficient supply of concrete or earth-fill arch dam should be used as it needs minimum amount of construction concrete.
- The slope of the adjoining hills for the abutment should be steep i.e. more than 45 degrees.
- During the design of the arch dam it is considered that the stresses generated are upto that of allowable stresses of the concrete.

#### **Advantages of Arch Dam – Few but long lasting**

- The major advantage derived from Arch dam is minimal amount of concrete / filling material required as the stresses of the thrust of water is taken care by both arch action and cantilever action requiring considerably small width at the bottom.
- These dams are best suited for a narrow canyon passage and can store water as well as generate electricity.

3. Arch dams are particularly adapted to the gorges where the length is small in proportion to the height.
4. For a given height, the section of an arch dam is much lesser than a corresponding gravity dam.
5. Hence, an arch dam requires less material and is, therefore, cheaper.
6. Because of much less base width, the problems of uplift pressure are minor.
7. Since only a small part of water load is transferred to the foundation by cantilever action, an arch dam can be constructed in moderate foundations where gravity dam requiring sound foundation rock may be unsuitable.

### Disadvantages of Arch Dam.

1. Arch dams are particularly adapted to the gorges where the length is small in proportion to the height.
2. For a given height, the section of an arch dam is much lesser than a corresponding gravity dam.
3. Hence, an arch dam requires less material and is, therefore, cheaper.
4. Because of much less base width, the problems of uplift pressure are minor.
5. Since only a small part of water load is transferred to the foundation by cantilever action, an arch dam can be constructed in moderate foundations where gravity dam requiring sound foundation rock may be unsuitable.

### Components a Typical Arch dam is composed of

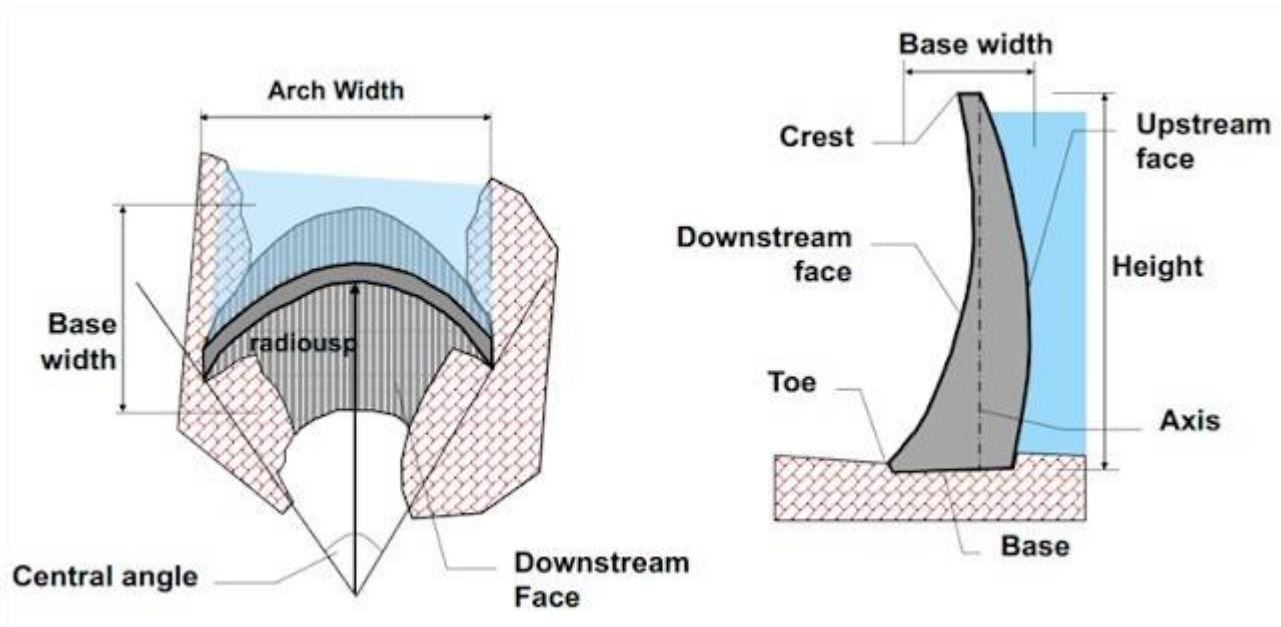

Above is a typical plan and cross-section of an arch dam showing typical components / parts of an arch dam.



## Types of Arch Dams

### Shell – Arch Dam – A famous and Aesthetic marvel

- Researchers have shown that greater the curvature of the arch dam in plan, the greater is the stresses on the abutments and thus lesser is the base width or thickness required.
- This economy can be further increased by providing curvature in the section making it a shell like or plate like structure.
- Such a non-vertical and shell like arch dam is termed as double curvature arch dam or shell-arch dam.
- Simple arch dams whose major part is distributed through the cantilever part of the arch dam can also be divided into different types as their faces can be either curvilinear or non-linear.
  1. Constant Radii Arch Dam
  2. Variable radii arch dam
  3. Constant angle arch dam

### Constant Radii Arch Dam Best suited for U-Shaped Valley

The picture above clearly explains the definition of Constant Radius Arch dam;

In Constant Radius Arch Dam, the radius of the outside Circular Curve (as shown in fig R1) is constant throughout the height / elevation of the dam creating a linear upstream face of the dam.

However, the inner curves of the arch are of variable radii i.e. from top to bottom elevation of the arch dam the radius of the curves reduces creating a triangular cross-section of the arch dam as shown in the figure.

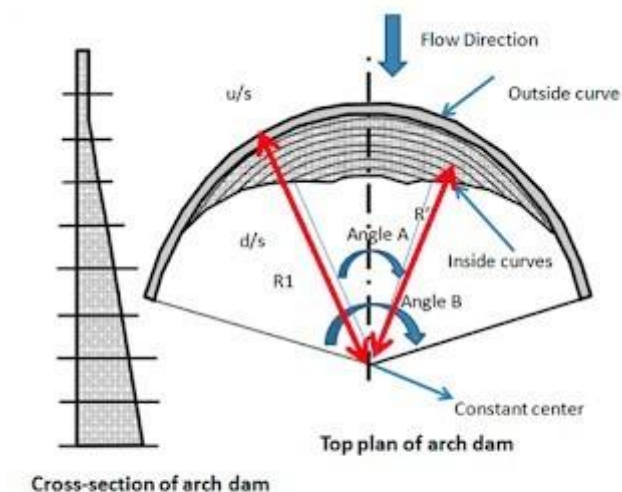

*Constant Radii Arch Dam Best suited for U-Shaped Valley*

### Constant Radii Arch Dam Best suited for U-Shaped Valley

- The increased thickness of the dam at the base will take care of the proportionally increasing hydrostatic thrust of the impounding water.

- It is to be noted here that the outside (upstream side) circular curves are sometimes termed as extrudes while that of inside curves are termed as intrudes.
- The constant Radii arch dam is sometimes referred as constant center arch dam; it is because of the fact that although the radii of the intrudes decreases as we move down the elevation of the dam however the center of the curve is at the same line / point i.e. center of the curves are fixed.
- There is one more term associated with the arch dam which is central angle of the arch curves. If you see at the above figure; the central angle of the intrudes decreases from top to bottom i.e. maximum central angle is at the top while minimum is at the bottom.
- Constant Radii or variable angle arch dams are most suitable for U-shaped valleys and is for easy construction providing vertical upstream face for efficient stress taking capacity.

### Variable Radii Arch Dam Best Suited for V-shaped valley

- Now after reading Constant radii arch dam you might be able to define what is variable radii arch dam. If not let me do this for you; a Variable radii arch dam is the one in which the radius of the intrudes as well that of extrados vary along the height.
- Making it maximum at the top and minimum at the bottom elevations. Along with the radius the central angle also become bigger and wider making it more effective and economical.

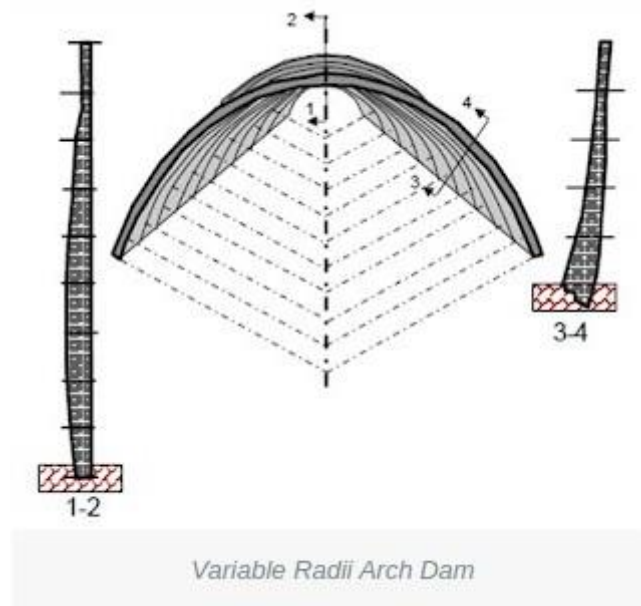

Variable Radii Arch Dam

- In a typical design of such a dam, the downstream face of the dam at the central line (crown) is vertical; while at all other locations, there is a batter on both the sides except at the abutments, where again, the upstream side becomes vertical.
- If overhangs are permitted, due to availability of stronger foundations, then the faces at the crown as well as abutments, may be provided with overhangs, affecting saving in the designed thickness.

- Evidently, since in such an arch dam, the centers of the various arch rings at different elevations, do not lie on the same vertical line; it is also known as variable center arch dam. Such dams are preferred for V-shaped valleys.

### **Constant Angle Arch Dams – An intermediate and most economic**

- The constant angle arch dam is a special type of variable radius arch dam, in which the central angles of the horizontal arch rings are of the same magnitude at all elevations.
- The design of such a dam can, thus be made by adopting best central angle of 133 degrees and 34 minutes; and hence such a dam proves to be the most economical, out of the three types of ordinary arch dams.
- However, the design of such a dam usually involves providing overhangs at abutments, which require stronger foundations, and hence such a type cannot be used if the foundations are weak.

### **Design of Arch Dams – a complex hectic job**

- As already explained above that the arch dam is a complex structure which is a bit difficult to design and construct.
- The design procedure adopted is a hit and trial type, a hydraulic dam design is proposed which is carried out through lengthy calculations for testing and checking through different criterions thus after several tries an economical, feasible and safe working design of the dam is developed.
- As far as the loads are concerned, the arch dam is designed for the same types of loads a concrete gravity dam is designed for. These loads includes :-
  - Water Pressure
  - Earthquake pressure
  - Wave pressure
  - Ice pressure
  - Temperature forces
  - Silt load
- However it is important here to understand that importance of above mentioned factor may be a bit for some types of loads and may be not for the other one.
- Like in case of arch dams we know the base width is comparatively very small to that of the concrete gravity dam, thus the uplift forces will be small.
- Mostly in the design of arch dams the uplift forces are neglected.

### **Arch dams are designed and engineered by three famous methods :-**

1. Thin cylinder theory
2. Theory of elastic arches
3. The trial load method

### **Diversion headwork.**

- Any hydraulic structure, which supplies water to the off-taking canal, is called a headwork.
- A diversion headwork serves to divert the required supply in to the canal from the river.

### **The purposes of diversion headwork.**

1. It raises the water level in the river so that the commanded area can be increased.
2. It regulates the intake of water in to the canal.
3. It controls the silt entry in to the canal.
4. It reduces fluctuations in the level of supply in the river.
5. It stores water for tiding over small periods of short supplies.

### **LOCATION OF DIVERSION HEADWORKS**

- The diversion headworks are generally located in the boulder stage or trough stage of the river at a site which is close to the commanded area of the offtaking canals.
  - If there are a number of sites which are suitable, the final selection is done on the basis of cost.
  - The site which gives the most economical arrangement for the diversion head works and the distribution works (canals) is usually selected.
1. The river section at the site should be narrow and well-defined.
  2. The river should have high, well-defined, inerodible and non-submersible banks so that the cost of river training works is minimum.
  3. The canals taking off from the diversion head works should be quite economical and should have a large commanded area.
  4. There should be suitable arrangement for the diversion of river during construction.
  5. The site should be such that the weir (or barrage) can be aligned at right angles to the direction of flow in the river.
  6. There should be suitable locations for the undersluices, head regulator and other components of the diversion headworks.
  7. The diversion headworks should not submerge costly land and property on its upstream.
  8. Good foundation should be available at the site.
  9. The required materials of construction should be available near the site.
  10. The site should be easily accessible by road or rail.
  11. The overall cost of the project should be a minimum.

## COMPONENT PARTS OF A DIVERSION HEADWORK

A diversion headwork consist of the following component parts

1. Weir or barrage
2. Undersluices
3. Divide wall
4. Fish ladder
5. Canal head regulator
6. pocket or approach channel
7. Silt excluders/ Silt prevention devices/
8. River training works (Marginal bunds and guide banks)

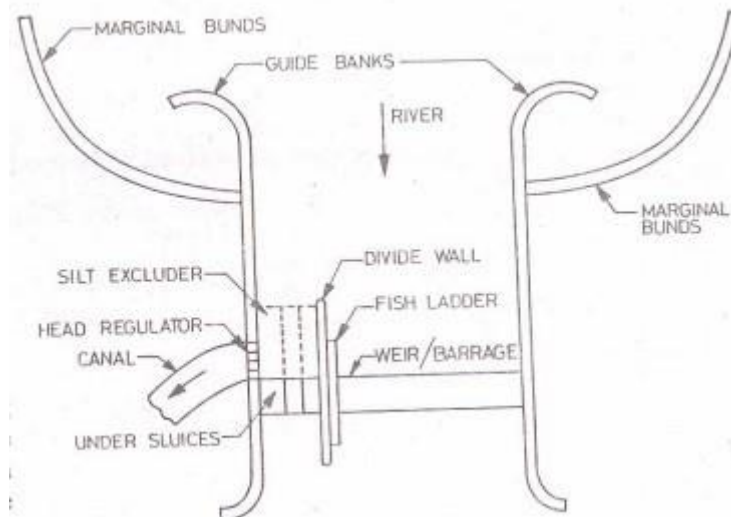

### Undersluices

- Undersluice sections are provided adjacent to the canal head regulators.
- The undersluices should be able to pass fair weather flow for which the crest shutters on the weir proper need not be dropped.
- The crest level of the undersluices is generally kept at the average bed level of the river.

### Divide Wall

- A divide wall is a wall constructed parallel to the direction of flow of river to separate the weir section and the undersluices section to avoid cross flows.
- If there are undersluices at both the sides, there are two divide walls.

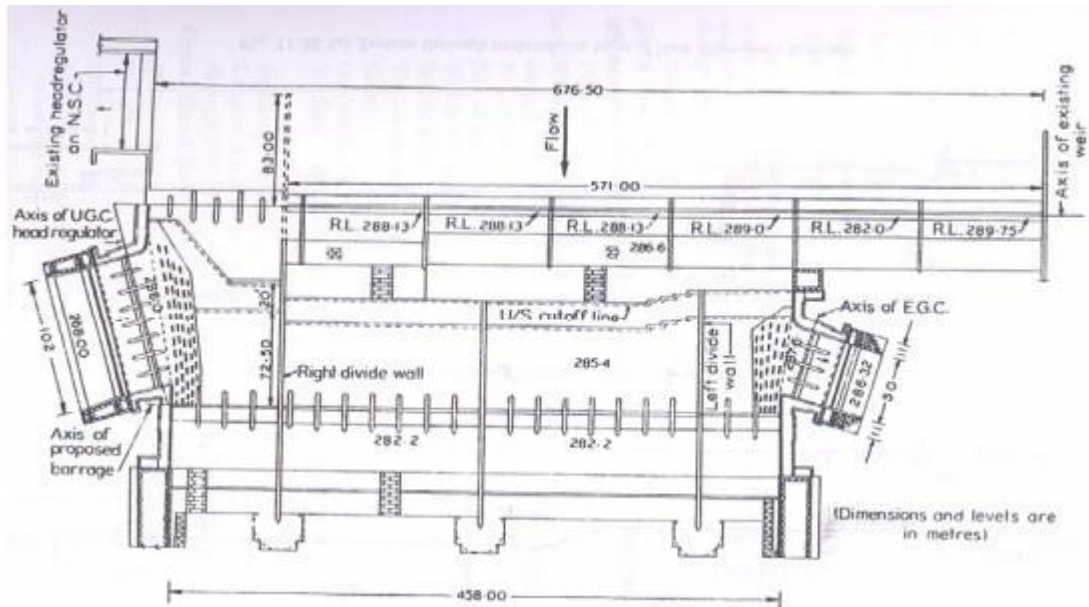

### Fish Ladder

- A fish ladder is a passage provided adjacent to the divide wall on the weir side for the fish to travel from the upstream to the downstream and vice versa.
- Fish migrate upstream or downstream of the river in search of food or to reach their sprawling places.
- In a fish ladder the head is gradually dissipated so as to provide smooth flow at sufficiently low velocity.
- Suitable baffles are provided in the fish passage to reduce the flow velocity.

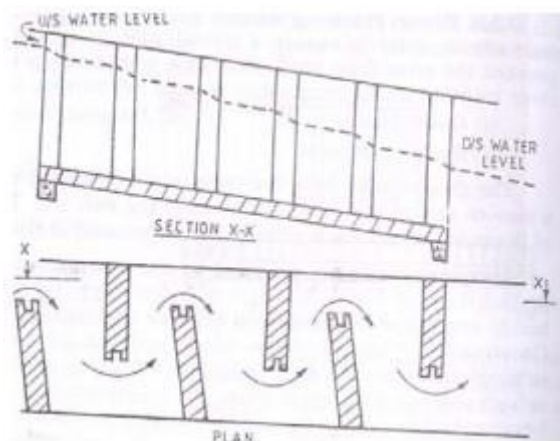

### Canal Head Regulator

- A canal head regulator is provided at the head of the canal offtaking from the diversion headworks.
- It regulates the supply of water into the canal, controls the entry silt into the canal, and prevents the entry of river floods into canal.

## Silt Excluder

- A silt excluder is a structure in the undersluices pocket to pass the silt laden water to the downstream so that only clear water enters into the canal through head regulator.
- The bottom layer of water which are highly charged with silt pass down the silt excluder an escape through the undersluices.

## Guide Banks and Marginal Bunds

- Guide banks are provided on either side of the diversion headworks for a smooth approach and to prevent the river from outflanking.
- Marginal bunds are provided on either side of the river upstream of diversion headworks to protect the land and property which is likely to be submerged during ponding of water in floods.

### Weir or Barrage

- A diversion head works is a structure constructed across a river for the purpose of raising water level in the river so that it can be diverted into the offtaking canals.
- A weir is a raised concrete crest wall constructed across the river.
- It may be provided with small shutters (gates) on its top. In the case of weir, most of the raising of water level or ponding is done by the solid weir wall and little with by the shutters.

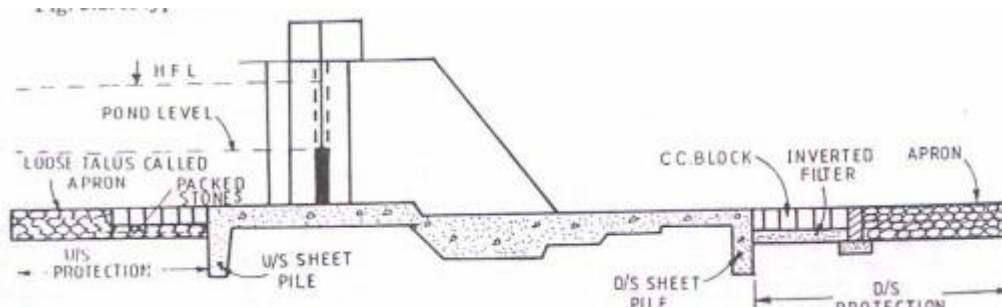

barrage has a low crest wall with high gates. As the height of the crest above the river bed is low most of the ponding is done by gates. During the floods the gates are opened so afflux is very small.

- A weir maintains a constant pond level on its upstream side so that the water can flow into the canals with the full supply level (F.S.L.). If the difference between the pond level and the crest level is less than 1.5 m or so, a weir is usually constructed.
- On the other hand, if this difference is greater than 1.50 m, a gate-controlled barrage is generally more suitable than a weir. In the case of a weir, the crest shutters are dropped during floods so that the water can pass over the crest.
- During the dry period, these shutters are raised to store water upto the pond level. Generally, the shutters are operated manually, and there is no mechanical arrangement for raising or dropping the shutters.
- On the other hand, in the case of a barrage, the control of pondage and flood discharge is achieved with the help of gates which are mechanically operated

## **ADVANTAGES AND DISADVANTAGES OF WEIRS AND BARRAGES**

**1. Weirs Advantages:** The initial cost of weirs is usually low.

### **Disadvantages:**

- i. There is a large afflux during floods which causes large submergence.
- ii. Because the crest is at high level, there is great silting problem
- iii. The raising and lowering of shutters on the crest is not convenient. Moreover, it requires considerable time and labour.
- iv. The weir lacks an effective control on the river during floods.

### **2. Barrages Advantages**

- i. The barrage has a good control on the river during floods. The outflow can be easily regulated by gates.
- ii. The afflux during floods is small and, therefore, the submerged area is less.
- iii. There is a good control over silt entry into the canal.
- iv. There is a good control over flow conditions, shoal formations and crosscurrents on the upstream of the barrage.
- v. There are better facilities for inspection and repair of various structures.
- vi. A roadway can be conveniently provided over the structure at a little additional cost.

### **Disadvantages:**

The initial cost of the barrage is quite high.

**Conclusion:** A barrage is generally better than a weir. Most of the diversion headworks these days usually consist of barrages.

## **TYPES OF WEIRS**

The weirs may be broadly divided into the following types

1. Vertical drop weirs.
2. Rockfill weirs.
3. Concrete glacis or sloping weirs.

### **1. Vertical drop weirs**

- A vertical drop weir consists of a masonry wall with a vertical (or nearly vertical) downstream face and a horizontal concrete floor.



- The shutters are provided at the crest, which are dropped during floods so as to reduce afflux. The water is ponded upto the top of the shutters during the rest of the period.
- Vertical drop weirs were quite common in early diversion headworks, but these are now becoming more or less obsolete.
- The vertical drop weir is suitable for hard clay foundation as well as consolidated gravel foundations, and where the drop is small.
- The upstream and downstream cutoff walls (or piles) are provided upto the scour depth. The weir floor is designed as a gravity section.

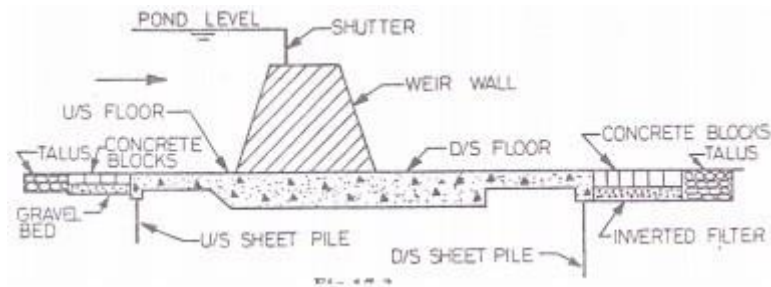

## 2. Rockfill weirs:

- In a rockfill type weir, in addition to the main weir wall, there are a number of core walls. The space between the core walls is filled with the fragments of rock (called rockfill).
- A rockfill weir requires a lot of rock fragments and is economical only when a huge quantity of rockfill is easily available near the weir site.
- It is suitable for fine sand foundation. The old Okhla Weir across the Yamuna river is a rockfill weir.
- Such weirs are also more or less obsolete these days.

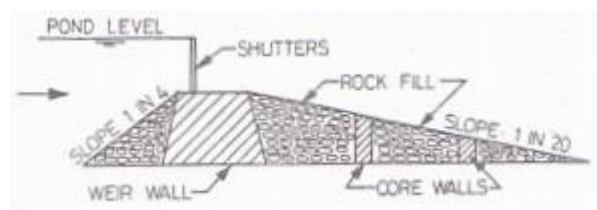

## 3. Concrete sloping weir :

- Concrete sloping weirs (or glacis weirs) are of relatively recent origin.
- The crest has glacis (sloping floors) on upstream as well as downstream.
- There are sheet piles (or cut off walls) driven upto the maximum scour depth at the upstream and downstream ends of the concrete floor.
- Sometimes an intermediate pile is also driven at the beginning of the upstream glacis or at the end of downstream glacis.

- The main advantage of a sloping weir over the vertical drop weir is that a hydraulic jump is formed on the d/s glacis for the dissipation of energy.
- Therefore, the sloping weir is quite suitable for large drops.

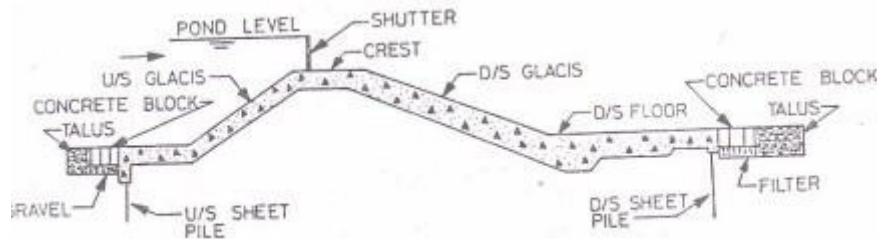

### **Modes of Failure :**

- Irrigation structures (or hydraulic structures) for the diversion and distribution works are weirs, barrages, head regulators, distributary head regulators, cross regulators, cross-drainage works, etc.
- These structures are generally founded on alluvial soils which are highly pervious. Moreover, these soils are easily scoured when the high velocity water passes over the structures.
- The failures of weirs constructed on the permeable foundation may occur due to various causes, which may be broadly classified into the following two categories:

#### **1. Failure due to- subsurface flow**

#### **2. Failure due to surface flow**

#### **1. Failure due to subsurface flow:**

The failure due to subsurface flow may occur by piping or by rupture of floor due to uplift.

#### **(a) Failure by piping:**

- Piping (or undermining) occurs below the weir if the water percolating through the foundation has a large seepage force when it emerges at the downstream end of the impervious floor.
- When the seepage force exceeds a certain value, the soil particles are lifted up at the exit point of the seepage.
- With the removal of the surface soil particles, there is further concentration of flow in the remaining portion and more soil particles are removed.
- This process of backward erosion progressively extends towards the upstream side, and a pipe-like hollow formation occurs beneath the floor.
- The floor ultimately subsides in the hollows so formed and fails. This type of failure is known as piping failure.

### **(b) Failure by rupture of floor:**

- The water percolating through the foundation exerts an upward pressure on the impervious floor, called the uplift pressure.
- If the weight of the floor is not adequate to counterbalance the uplift pressure, it may fail by rupture.

### **2. Failure due to surface flow**

The failure due to surface flow may occur by suction pressure due to hydraulic jump or by scouring of the bed.

#### **(a) Failure by suction pressure :**

- In the glacis type of weirs, a hydraulic jump is formed on the d/s glacis. In this case, the water surface profile in the hydraulic jump trough is much lower than the subsoil H.G.L.
- Therefore uplift pressure occurs on the glacis. This uplift pressure is known as the suction pressure. If the thickness of floor is not adequate, the rupture of floor may occur.

#### **(b) Failure by scour :**

- During floods, scouring occurs in the river bed. The bed of the river may be scoured to a considerable depth.
- If no suitable measures are adopted, the scour may cause damage to the structure and may lead to the failure.

### **Design aspects**

The basic principles for the design of all irrigation structures on pervious foundations are as follows:

#### **(a) Subsurface flow**

1. The structure should be designed such that the piping failure does not occur due to subsurface flow.
2. The downstream pile must be provided to reduce the exit gradient and to prevent piping.
3. An impervious floor of adequate length is provided to increase the path of percolation and to reduce the hydraulic gradient and the seepage force.
4. The seepage path is increased by providing piles and impervious floor to reduce the uplift pressure.
5. The thickness of the floor should be sufficient to resist the uplift pressure due to subsurface flow. The critical section is d/s of the weir/crest wall.

6. A suitably graded inverted filter should be provided at the downstream end of the impervious floor to check the migration of soil particles along with water. The filter layer is loaded with concrete blocks. Concrete blocks are also provided at the upstream end.

**(b) Surface flow**

1. The piles (or cutoff walls) at the upstream and downstream ends of the impervious floor should be provided upto the maximum scour level to protect the main structure against scour.
2. The launching aprons should be provided at the upstream and downstream ends to provide a cover to the main structure against scour.
3. A device is required at the downstream to dissipate energy. For large drops, hydraulic jump is used to dissipate the energy.
4. Additional thickness of the impervious floor is provided at the point where the hydraulic jump is formed to counterbalance the suction pressure.
5. The floor is constructed as a monolithic structure to develop bending resistance (or beam action) to resist the suction pressure.

\*\*\*\*\*

## UNIT – 4

### **CANAL IRRIGATION**

Canal regulations – direct sluice - Canal drop – Cross drainage works-Canal outlets – Design of prismatic canal-canal alignments-Canal lining - Kennedy’s and Lacey’s Regime theory-Design of unlined canal

#### **CANAL:-**

A canal is an artificial channel generally trapezoidal in shape constructed on the ground to carry water to the field either from the river or from a reservoir.

#### **Canal regulations**

Any structure constructed to regulate the discharge, full supply level or velocity in a canal is known as Regulation Work.

#### **Types & Location:**

1. Head Regulator or Head Sluice → at Barrage/Weir, Dam
2. Cross Regulator → on Parent Canal
3. Distributory Head Regulator → on Off-take Canal
4. Canal Fall → along Parent Canal or Off-take Canal
5. Canal Escape → on any type of canal
6. Canal Outlet → on Distributing Canal

#### **Types & Purpose:**

1. Head Regulator or Head Sluice → to divert water to parent channel from a barrage or weir
2. Cross Regulator → to head up water in the parent channel to divert some of it through an off take channel or distributory canal
3. Distributory Head Regulator → to control the amount of water flowing in to off take channel
4. Canal Fall → to lower the water level of the canal
5. Canal Escape → to allow release of excess water from the canal system
6. Canal Outlet → to take out water for delivery to the field channel or water courses

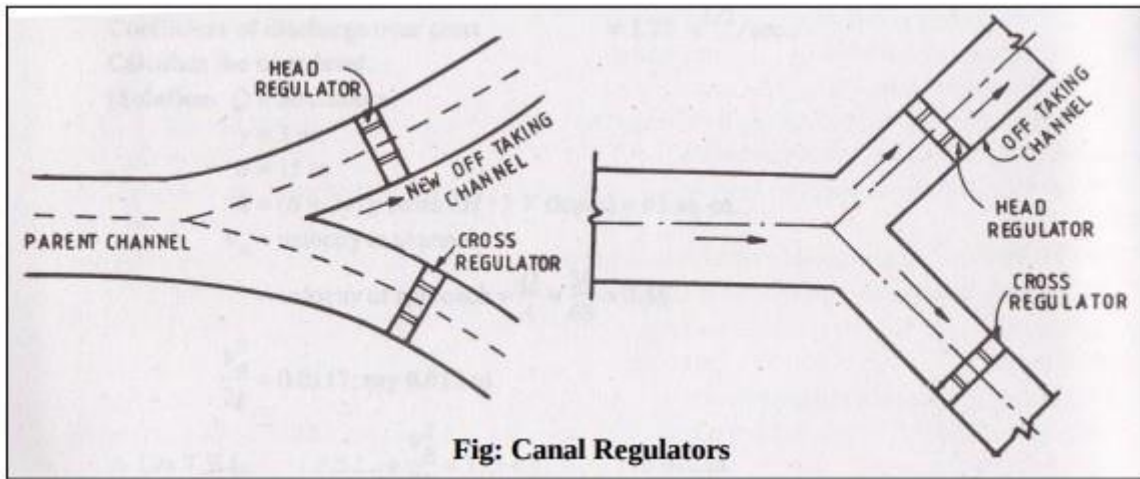

**Fig: Canal Regulators**

A head regulator provided at the head of the off-taking channel, controls the flow of water entering the new channel.

While a cross regulator may be required in the main channel downstream of the off-taking channel, and is operated when necessary so as to head up water on its upstream side, thus to ensure the required supply in the off-taking channel even during the periods of low flow in the main channel.

**Main functions of a head regulator:**

1. To regulate or control the supplies entering the off-taking canal
2. To control the entry of silt into the off-taking canal
3. To serve as a meter for measuring discharge.

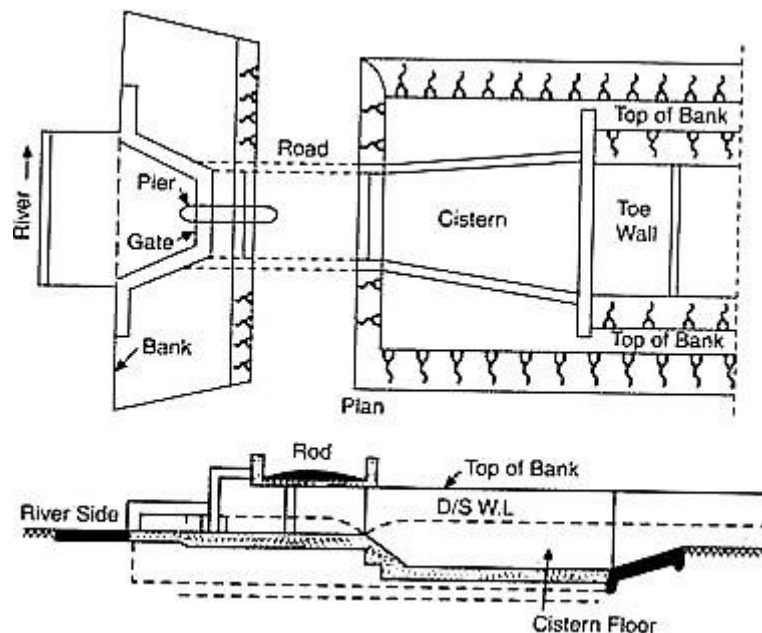

**Fig. 12.11. Head regulator**

- It consists of a raised crest with abutments on both sides. The crest may be subdivided in various bays by providing piers on the crest.

- The piers support roadway and a platform for operating gates.
- The gates control the flow over the crest. They are housed and operated in grooves made in the abutments and piers. Sill of the regulator crest is raised to prevent silt entry.
- Sometimes the gates are provided in tiers. Then lower tiers may be kept closed to raise the sill of the regulator.
- The head regulator is generally constructed with masonry. It should be founded on a good rock foundation. It should be safe against shear, sliding and overturning.
- It should be flanked with adequate wing walls. The head regulator should also be given proper protection by providing aprons on upstream and downstream side of the barrel.
- To prevent seepage cutoff is also essential. To take irrigation water at low velocities waterway of the head regulator should be sufficiently big.

### **Main functions of a cross regulator:**

1. To control the entire Canal Irrigation System.
2. To help in heading up water on the upstream side and to feed the off-taking canals to their full demand.
3. To help in absorbing fluctuations in various sections of the canal system, and in preventing the possibilities of breaches in the tail reaches.
4. Cross regulator is often combined with bridges and falls, if required.

### **Canal Escapes:**

It is a side channel constructed to remove surplus water from an irrigation channel (main canal, branch canal, or distributary etc.) into a natural drain.

The water in the irrigation channel may become surplus due to -

- Mistake
- Difficulty in regulation at the head
- Excessive rainfall in the upper reaches
- Outlets being closed by cultivators as they find the demand of water is over

### **Functions of Distributary Head Regulator:**

- It is a hydraulic structure constructed at the head of a distributary. This regulator performs the same functions as that of a head regulator.

- i. It regulates the supply of the distributary.
  - ii. It can be used many times as a meter.
  - iii. It is also a silt selective structure.
  - iv. Distributary head regulator controls the flow in the distributary. By closing the gates distributary can be dried to carry out repairs or maintenance works.
- The points to be considered in design are similar to those considered in the design of a head regulator.
  - Only difference is that the distributary head regulator is much smaller in magnitude as compared to the head regulator.

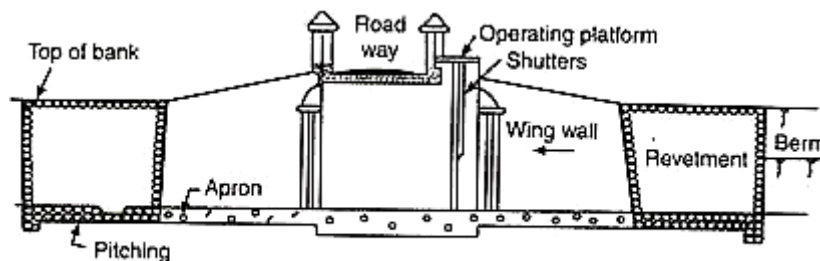
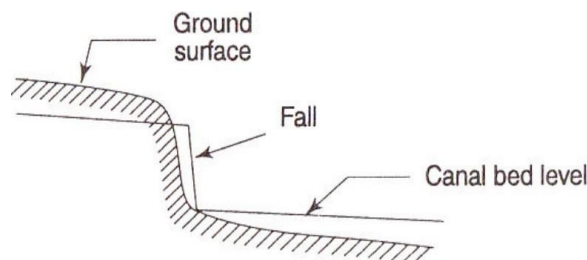

Fig. 12.13. Distributary head regulator

### Canal drop or Fall

A canal fall or drop is an irrigation structure constructed across a canal to lower down its bed level to maintain the designed slope when there is a change of ground level to maintain the designed slope when there is change of ground level.

This falling water at the fall has some surplus energy. The fall is constructed in such a way that it can destroy this surplus energy



### Types of Canal Fall:

1. Ogee Fall - to provide smooth transition and to reduce disturbance and impact
2. Rapid Fall - consists of a glacis sloping at 1: 0 to 1:20. Very high cost of construction
3. Stepped Fall - next development of rapid fall. Cost of construction is high



4. Notch Fall - the fall is consists of one or more trapezoidal notches

5. Vertical Drop Fall - high velocity jet enters the deep pool of water in the cistern and dissipation of energy is affected by turbulent diffusion

6. Glacis Type Fall - utilizes standing wave phenomenon for dissipation of energy

**Types:**

a) Straight Glacis Type

b) Parabolic Glacis Type of Montague type

**Ogee Fall**

In this type of fall, an ogee curve (a combination of convex curve and concave curve) is provided for carrying the canal water from higher level to lower level. This fall is recommended when the natural ground surface suddenly changes to a steeper slope along the alignment of the canal.

- The fall consists of a concrete vertical wall and concrete bed.
- Over the concrete bed the rubble masonry is provided in the shape of ogee curve.
- The surface of the masonry is finished with rich cement mortar (1:3).
- The upstream and downstream side of the fall is protected by stone pitching with cement grouting.
- The design consideration of the ogee fall depends on the site condition.

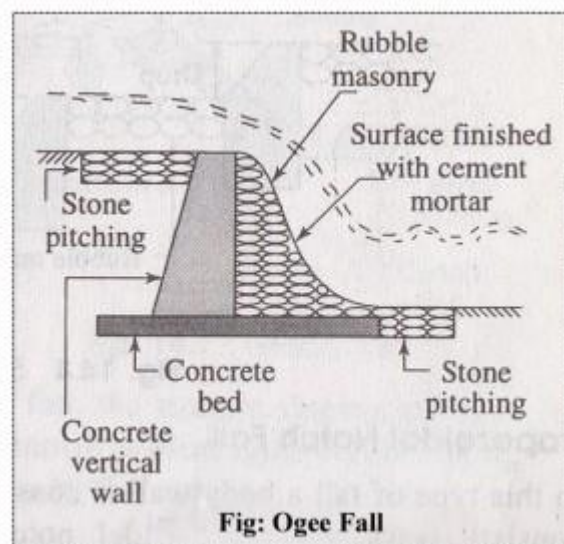

**Rapid Fall**

The rapid fall is suitable when the slope of the natural ground surface is even and long. It consists of a long sloping glacis with longitudinal slope which varies from 1 in 10 to 1 in 20.

- Curtain walls are provided on the upstream and downstream side of the sloping glacis.
- The sloping bed is provided with rubble masonry.
- The upstream and downstream side of the fall is also protected by rubble masonry.
- The masonry surface is finished with rich cement mortar (1: 3).

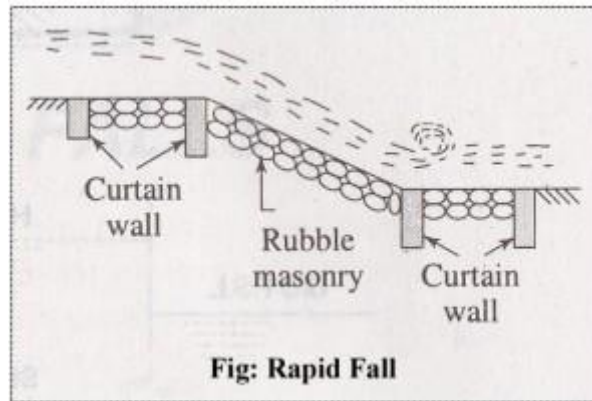

### Stepped Fall

Stepped fall consists of a series of vertical drops in the form of steps. This fall is suitable in places where the sloping ground is very long and requires long glacis to connect the higher bed level with lower bed level.

- This fall is practically a modification of the rapid fall.
- The sloping glacis is divided into a number of drops so that the flowing water may not cause any damage to the canal bed. Brick walls are provided at each of the drops.
- The bed of the canal within the fall is protected by rubble masonry with surface finishing by rich cement mortar (1:3).

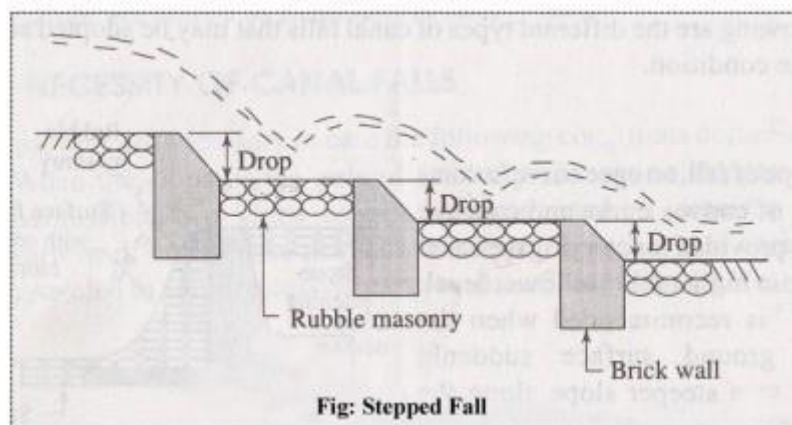

### Trapezoidal Notch Fall

In this type of fall a body wall is constructed across the canal. The body wall consists of several trapezoidal notches between the side piers and the intermediate pier or piers. The sills of the notches are kept at the upstream bed level of the canal.

- The body wall is constructed with masonry or concrete.
- An impervious floor is provided to resist the scoring effect of the falling water.
- The upstream and downstream side of the fall is protected by stone pitching finished by cement grouting.
- The size and number of notches depends upon the full supply discharge of the canal.

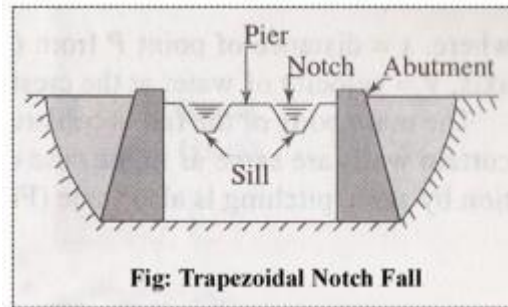

### Vertical Drop Fall

It consists of a vertical drop walls which is constructed with masonry work. The water flows over the crest of the wall. A water cushion is provided on the downstream side which acts as a water cushion to dissipate the energy of falling water.

- A concrete floor is provided on the downstream side to control the scouring effect of the flowing water.
- Curtain walls are provided on the upstream and downstream side.
- Stone pitching with cement grouting is provided on the upstream and downstream side of the fall to protect it from scouring.

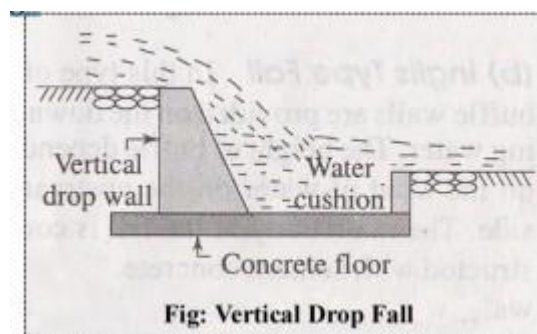

### Glacis Fall

It consists of a straight sloping glacis provided with a crest. A water cushion is provided on the downstream side to dissipate the energy of flowing water.

- The sloping glacis is constructed with cement concrete.
- Curtain walls and toe walls are provided on the upstream and downstream side.

- The space between the toe walls and curtain walls is protected by stone pitching.
- This type of fall is suitable for drops up to 1.5 m.

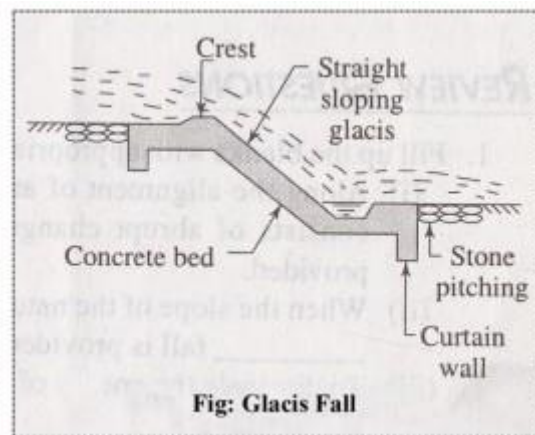

For the improvement in energy dissipation, the glacis falls have been modified as follows:

### (a) Montague Type Fall

In this type of fall, the straight sloping glacis is modified by giving parabolic shape which is known as Montague profile. Taking “0” as the origin, the Montague profile is given by the equation,

$$X = v \sqrt{4 \frac{Y}{g} + Y^2}$$

Where,  $x$  = distance of point P from OX axis,

$Y$  = distance of point P from OY axis,

$v$  = velocity of water at the crest,

$g$  = acceleration due to gravity

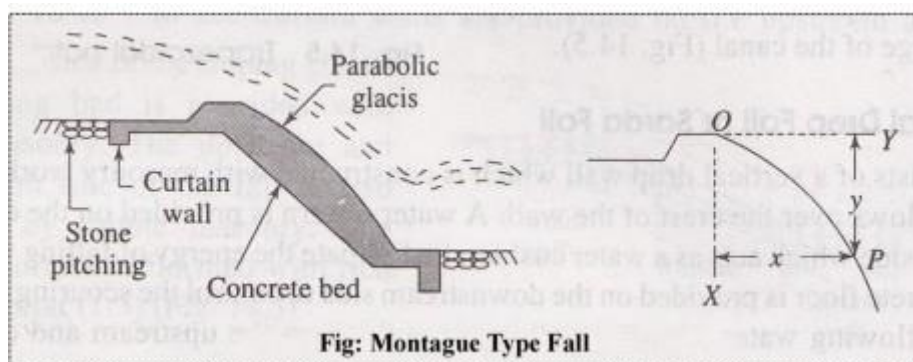

The main body of the fall is constructed with cement concrete. Toe walls and curtain walls are same as in the case of straight sloping glacis. The bed protection by stone pitching is also same.

### (b) Inglis Type Fall

In this type of fall, the glacis is straight and sloping, but baffle walls are provided on the downstream floor to dissipate the energy of flowing water.

- The height of baffle depends on the head of water on the upstream side.
- The main body of the fall is constructed with cement concrete.
- The toe walls and curtain walls are same as straight glacis.
- The protection works with stone pitching are also same. Sometimes, this fall is known as baffle fall.

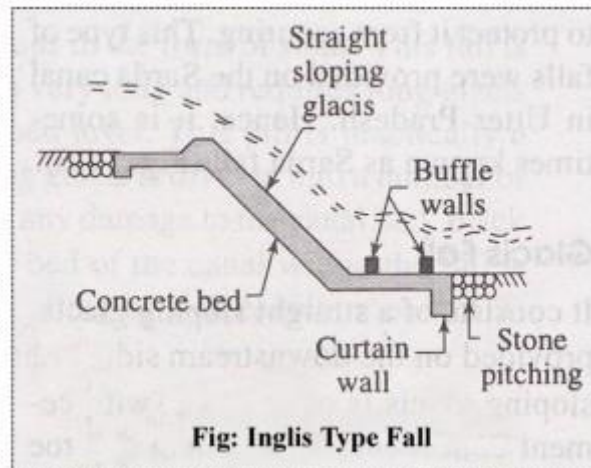

### Cross drainage works

- In an irrigation project, when the network of main canals, branch canals, distributaries, etc. are provided, then these canals may have to cross the natural drainages like rivers, streams, nallahs, etc at different points within the command area of the project.
- The crossing of the canals with such obstacle cannot be avoided. So, suitable structures must be constructed at the crossing point for the easy flow of water of the canal and drainage in the respective directions. These structures are known as cross-drainage works.

### Necessity of Cross-drainage works:

- The water-shed canals do not cross natural drainages. But in actual orientation of the canal network, this ideal condition may not be available and the obstacles like natural drainages may be present across the canal. So, the cross drainage works must be provided for running the irrigation system.
- At the crossing point, the water of the canal and the drainage get intermixed. So, for the smooth running of the canal with its design discharge the cross drainage works are required.
- The site condition of the crossing point may be such that without any suitable structure, the water of the canal and drainage can not be diverted to their natural directions. So, the cross drainage works must be provided to maintain their natural direction of flow.

### Types of Cross-Drainage Works:

#### (1) Type I (Irrigation canal passes over the drainage)

- a) Aqueduct

b) Siphon aqueduct

**(2) Type II (Drainage passes over the irrigation canal)**

a) Super passage

b) Siphon super passage

**(3) Type III (Drainage and canal intersection each other of the same level)**

a) Level Crossing

b) Inlet and outlet

**Selection of type of cross-drainage works**

- Relative bed levels
- Availability of suitable foundation
- Economical consideration
- Discharge of the drainage
- Construction problems

**Aqueduct**

- The aqueduct is just like a bridge where a canal is taken over the deck supported by piers instead of a road or railway.
- Generally, the canal is in the shape of a rectangular trough which is constructed with reinforced cement concrete. Sometimes, the trough may be of trapezoidal section.
- An inspection road is provided along the side of the trough.
- The bed and banks of the drainage below the trough is protected by boulder pitching with cement grouting.
- The section of the trough is designed according to the full supply discharge of the canal.
- A free board of about 0.50 m should be provided.
- The height and section of piers are designed according to the highest flood level and velocity of flow of the drainage.
- The piers may be of brick masonry, stone masonry or reinforced cement concrete.
- Deep foundation (like well foundation) is not necessary for the piers. The concrete foundation may
- be done by providing the depth of foundation according to the availability of hard soil.

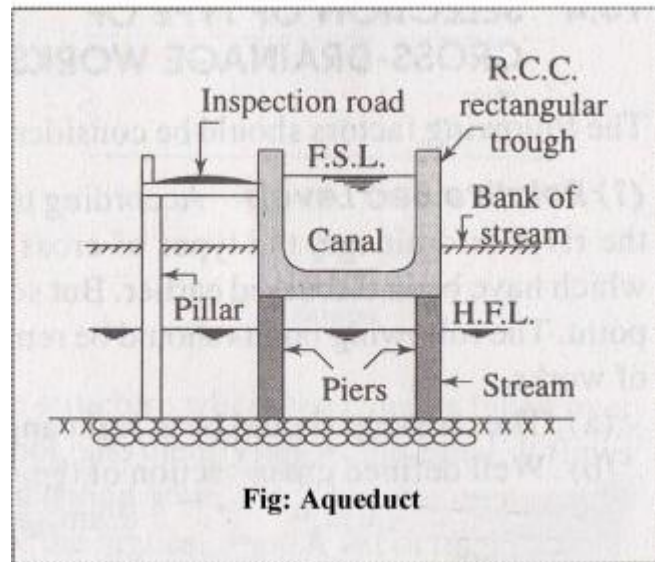

### Siphon Aqueduct

- The siphon aqueduct, the bed of the drainage is depressed below the bottom level of the canal trough by providing sloping apron on both sides of the crossing.
- The sloping apron may be constructed by stone pitching or cement concrete.
- The section of the drainage below the canal trough is constructed with cement concrete in the form of tunnel. This tunnel acts as a siphon.
- Cut off walls are provided on both sides of the apron to prevent scouring.
- Boulder pitching should be provided on the upstream and downstream of the cut-off walls.
- The other components like canal trough, piers, inspection road, etc. should be designed according to the methods adopted in case of aqueduct.

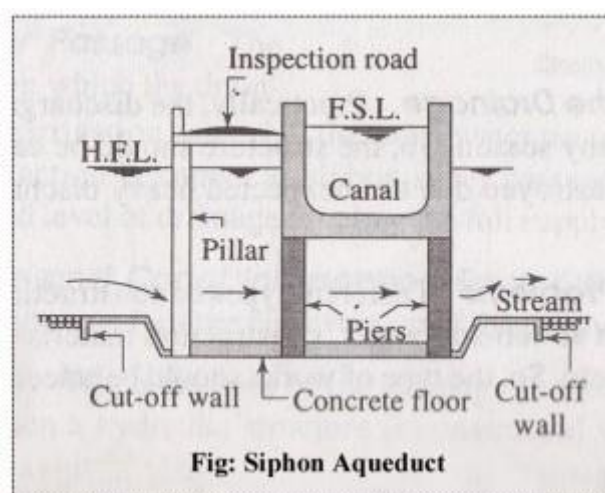

### Super Passage

- The super passage is just opposite of the aqueduct. In this case, the bed level of the drainage is above the fully supply level of the canal.
- The drainage is taken through a rectangular or trapezoidal trough of channel which is constructed on the deck supported by piers.

- The section of the drainage trough depends on the high flood discharge.
- A free board of about 1.5 m should be provided for safety.
- The trough should be constructed of reinforced cement concrete.
- The bed and banks of the canal below the drainage trough should be protected by boulder pitching or lining with concrete slabs.
- The foundation of the piers will be same as in the case of aqueduct.

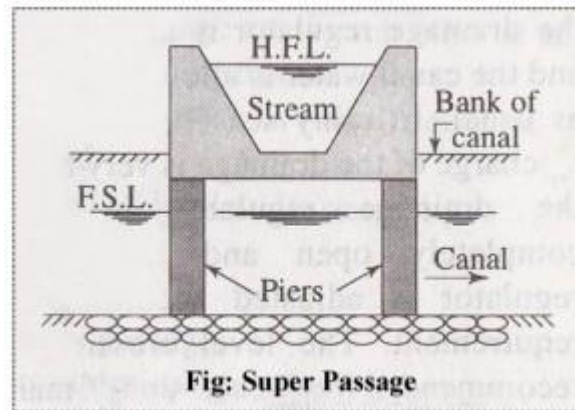

**Fig: Super Passage**

### Siphon Super Passage

- It is just opposite siphon aqueduct. In this case, the canal passes below the drainage trough. The section of the trough is designed according to high flood discharge.
- The bed of the canal is depressed below the bottom level of the drainage trough by providing sloping apron on both sides of the crossing.
- The sloping apron may be constructed with stone pitching or concrete slabs.
- The section of the canal below the trough is constructed with cement concrete in the form of tunnel which acts as siphon.
- Cut-off walls are provided on upstream and downstream side of sloping apron.
- Other components are same as in the case of siphon aqueduct.

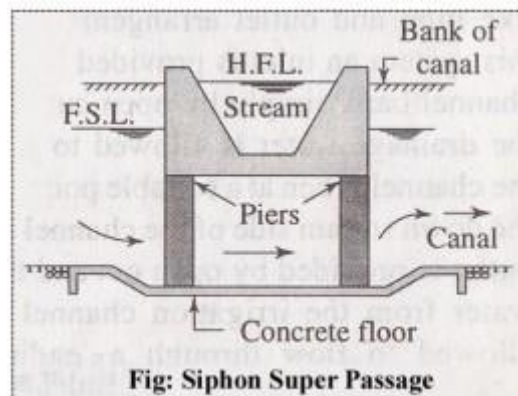

**Fig: Siphon Super Passage**



## Level Crossing

The level crossing is an arrangement provided to regulate the flow of water through the drainage and the canal when they cross each other approximately at the same bed level.

The level crossing consists of the following components:

**Crest Wall:** It is provided across the drainage just at the upstream side of the crossing point. The top level of the crest wall is kept at the full supply level of the canal.

**Drainage Regulator:** It is provided across the drainage just at the downstream side of the crossing point. The regulator consists of adjustable shutters at different tiers.

**Canal Regulator:** It is provided across the canal just at the downstream side of the crossing point. This regulator also consists of adjustable shutters at different tiers.

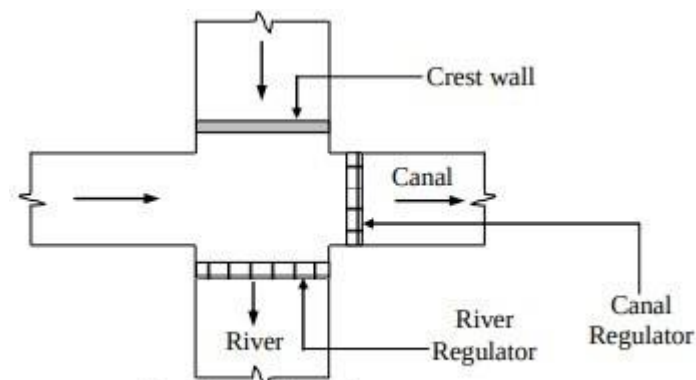

Fig: Level Crossing

## Inlet and outlet

- In the crossing of small drainage with small channel no hydraulic structure is constructed. Simple openings are provided for the flow of water in their respective directions. This arrangement is known as inlet and outlet.
- In this system, an inlet is provided in the channel bank simply by open cut and the drainage water is allowed to join the channel
- At the points of inlet and outlet, the bed and banks of the drainage are protected by stone pitching.

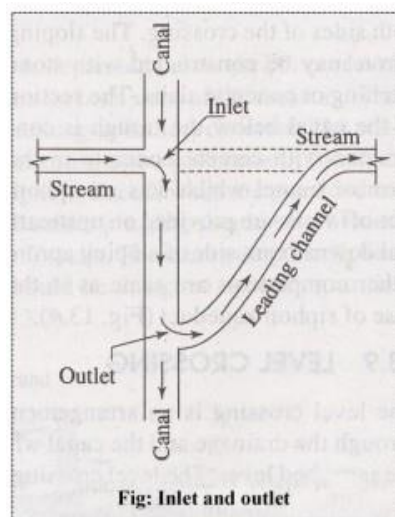

Fig: Inlet and outlet

### Canal Outlets/Modules:

- A canal outlet or a module is a small structure built at the head of the water course so as to connect it with a minor or a distributary channel.
- It acts as a connecting link between the system manager and the farmers.

### Requirements of a good module:

- It should fit well to the decided principles of water distribution.
- It should be simple to construct.
- It should work efficiently with a small working head.
- It should be cheaper.
- It should be sufficiently strong with no moving parts, thus avoiding periodic maintenance.
- It should be such as to avoid interference by cultivators.
- It should draw its fair share of silt.

### Types of Outlet/modules:

#### (a) Non-modular modules:

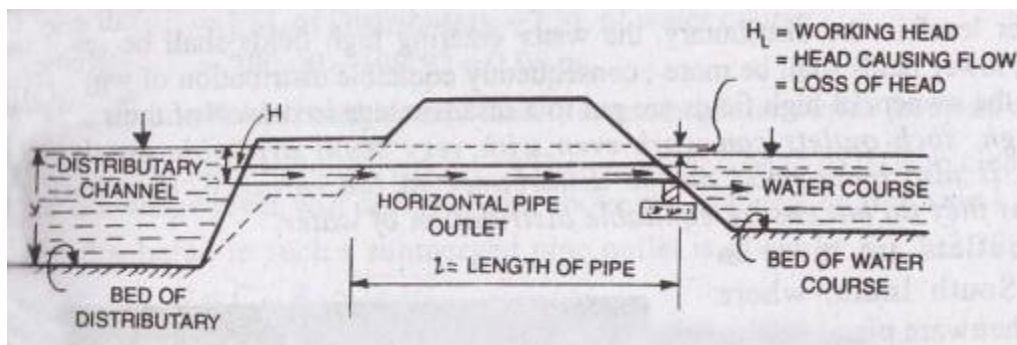

Non-modular modules are those through which the discharge depends upon the head difference between the distributary and the water course.

Common examples are:

- (i) Open sluice
- (ii) Drowned pipe outlet

#### (b) Semi-modules or Flexible modules:

Due to construction, a super-critical velocity is ensured in the throat and thereby allowing the formation of a jump in the expanding flume.

The formation of hydraulic jump makes the outlet discharge independent of the water level in water course, thus making it a semi module.

Semi-modules or flexible modules are those through which the discharge is independent of the water level of the water course but depends only upon the water level of the distributary so long as a minimum working head is available.

Examples are pipe outlet, open flume type etc.

### (c) Rigid modules or Modular Outlets:

Rigid modules or modular outlets are those through which discharge is constant and fixed within limits, irrespective of the fluctuations of the water levels of either the distributary or of the water course or both.

An example is Gibb's module:

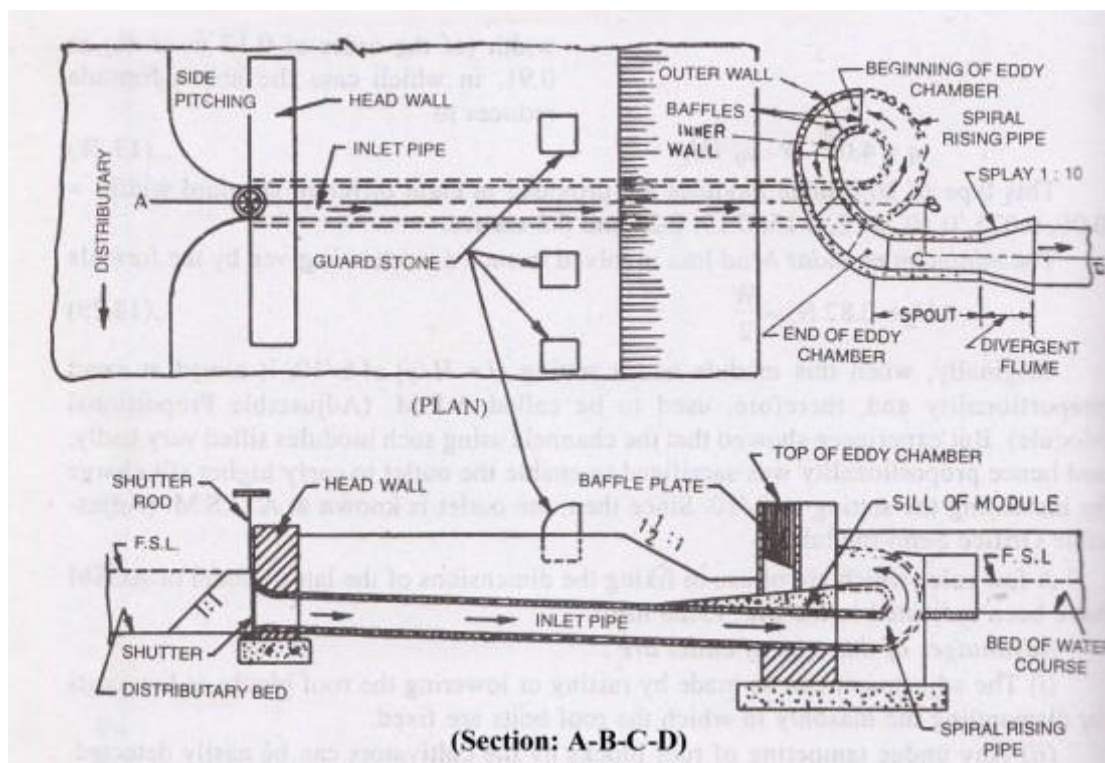

### Design of prismatic canal

#### Open Channels

Irrigation water is conveyed in either open channel or closed conduits.

Open channels receive water from natural streams or underground water and convey water to the farm for irrigation.

Open channels have free surface. The free surface is subjected to atmospheric pressure.

The basic equations used for water flow in open channels are continuity equation, Bernoulli equation and Darcy Weisbach equation.

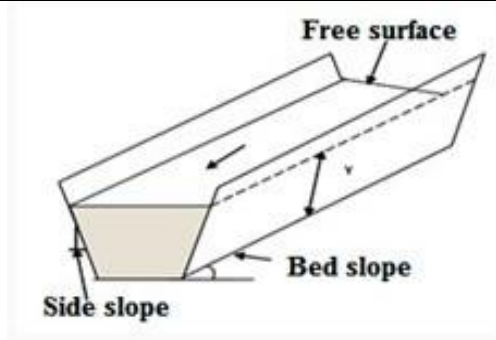

A trapezoidal shaped open channel

### Prismatic and Non-Prismatic Channels

- A channel in which the cross sectional shape, size and the bottom slope are constant over long stretches is termed as prismatic channel.
- Most of the man-made or artificial channels are prismatic channels.
- The rectangular, trapezoidal, triangular and half-circular are commonly used shapes in manmade channels.
- All natural channels generally have varying cross section and consequently are nonprismatic.

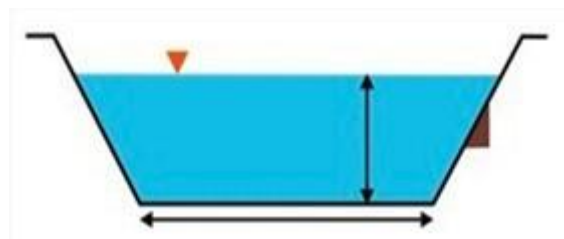

Sketch of a prismatic channel

### Design of Open Channel

- Open Channel is a passage through which water flows and has upper surface exposed to atmosphere.
- Open channel design involves determining cross-section dimensions of the channel for the amount of water the channel must carry (i.e., capacity) at a given flow velocity, slope and, shape or alternatively determining the discharge capacity for the given cross-section dimensions.

The terminologies used in the design of open channels of different geometry are given below:

#### i) Area of Cross Section (a):

Area of cross section of for a rectangular cross section, of wetted section. For a rectangular cross section, if  $b$  = width of channel and  $y$  = depth of water, the area of wetted section of channel (a) =  $b \cdot y$ .

#### ii) Wetted Perimeter (p):

It is the sum of the lengths of that part of the channel sides and bottom which are in contact with water. The wetted perimeter (p) =  $b + 2y$ .

#### iii) Hydraulic Radius (R):

It is the ration of area of wetted cross section to wetted perimeter. The hydraulic radius

$$(R) = \frac{a}{p} = \frac{by}{b+2y}$$

#### iv) Hydraulic Slope (S):

It is the ratio of vertical drop in longitudinal channel section (h) to the channel length (l). Hydraulic slope

$$(S) = \frac{h}{l}$$

#### v) Freeboard:

- It is the vertical distance between the highest water level anticipated in channel flow and the top of the retaining banks.
- This is provided to prevent over topping of channel embankments or damage due to trampling. This is provided between 15.25% of normal depth of flow.

### Discharge Capacity of Channel

Channel capacity can be estimated by equation given as:

$$Q = \frac{(16667)(DDIR)(A)}{(HPD)(Ei)}$$

where,

Q = channel capacity (L/min)

DDIR = design daily irrigation requirement (mm/day)

A = irrigated area supplied by canal or ditch (ha)

HPD = hours per day that water is delivered

Ei= irrigation efficiency including conveyance efficiency of canal or ditch (percent).

- The velocity of flow in a canal or ditch should be non erosive and non silting that prevent the deposition of suspended substances.
- Normally flow velocity in excess of 0.6 m/s is non silting (Schwab et al., 1993).
- The maximum velocity that does not cause excessive erosion depends on the erodibility of the soil or lining material.

### Economical Section of a Channel

- A channel section is said to be economical when the cost of construction of the channel is minimum.
- The cost of construction of a channel depends on depth of excavation and construction for lining.
- The cost of construction of channel is minimum when it passes maximum discharge for its given cross sectional area.
- It is evident from the continuity equation and uniform flow formulae that for a given value of slope and surface roughness, the velocity of flow is maximum when hydraulic radius is maximum.

## The conditions for the most economical section of channel

1. A rectangular channel section is the most economical when either the depth of flow is equal to half the bottom width or hydraulic radius is equal to half the depth of flow.
2. A trapezoidal section is the most economical if half the top width is equal to one of the sloping sides of the channel or the hydraulic radius is equal to half the depth of flow.
3. A triangular channel section is the most economical when each of its sloping side makes an angle of  $45^\circ$  with vertical or is half square described on a diagonal and having equal sloping sides.

The discharge from a channel is given by

$$Q = AV = AC\sqrt{RS_0} = AC\sqrt{\frac{A}{P}S_0} = K * \frac{1}{\sqrt{P}}$$

where  $Q$  = discharge ( $m^3/s$ ),  $A$  = area of cross section ( $m^2$ ),  $C$  = Chezy's constant,

$R$  = Hydraulic radius (m),  $P$  = wetted perimeter (m),  $S_0$  = bed slope (fraction or m/m),  $K$  = constant for given cross sectional area and bed slope and  $= A^{3/2}C S_0^{1/2}$  and the discharge  $Q$  will be maximum when the wetted perimeter  $P$  is minimum.

### (i) Channel Shape:

Among the various shapes of open channel the semi-circle shape is the best hydraulic efficient cross sectional shape. However the construction of semicircle cross section is difficult for earthen unlined channel. Trapezoidal section is commonly used cross section.

### (ii) Channel Dimensions:

The channel dimensions can be obtained using uniform flow formula, which is given by

$$Q = A V$$

Where,

$V$  = flow velocity (m/s)

$A$  = cross-sectional area of canal perpendicular to flow ( $m^2$ )

$Q$  = capacity of the channel ( $m^3/s$ )

Velocity is computed by Manning's formula or Chezy formula.

Manning's Equation is given by

$$V = \frac{1}{n} R^{2/3} S^{1/2}$$

Chezy's equation is given by

$$V = C R^{1/2} S^{1/2}$$

Where,

$n$  = Manning's roughness coefficient

$C$  = Chezy's roughness coefficient

$R$  = hydraulic radius (m)

$S$  = bed slope (m/m)

## Canal alignments

- It is now clear that irrigation water, in flow type, should reach the fields by gravity. To accomplish this requirement irrigation canal is always aligned in such a way that the water gets proper command over the whole irrigable area.
- Obviously if the canal follows a watershed or a ridge of the drainage area it will get necessary gravity flow. The watershed or the ridge is a dividing line between two drainage areas. Thus a canal which runs over the ridge gets command of area on both sides of the ridge.

Irrigation canals can be aligned in any of the three ways:

- 1.As watershed canal
- 2.As contour canal; and
- 3.As side slope canal

## Watershed Canal

- The dividing line between the catchment area of two drains (streams) is called the watershed.
- Thus, between two major stream, there is the main watershed which divides the drainage areas of the two.
- Similarly, between any tributary and the main stream, and also between any two tributaries there, are subsidiary watersheds, dividing the drainage between the two streams on either side.

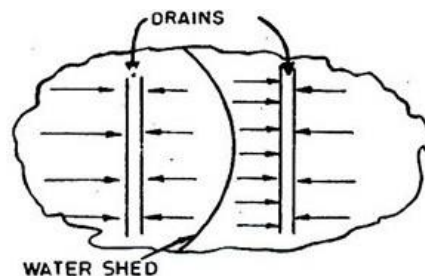

## (ii) Contour Canal:

- The above arrangement of providing the canals along the watershed is not possible in hill areas.
- In the hills, the river flows in the valley, while the watershed or the ridge line may be hundred of metres above it.
- It becomes uneconomical to take the canal on top of such a ridge. The channel, in such cases, is generate sufficient flow velocities, are given to it.

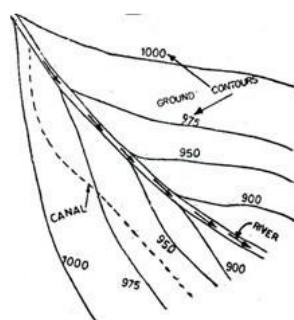

### iii) Side Slope Canal:

- A side slope channel is that which is aligned at right angles to the contours, i.e. along the side slopes, as shown in figure.
- Such a channel is parallel to the natural drainage flow and hence, does not intercept cross drainage, and hence no cross drainage works are required.

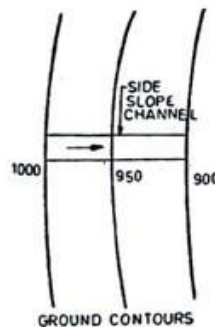

### Precautions in Canal Alignment:

While aligning a canal following points should be considered in general:

- i. The canal should be aligned on the ridge or in such a way as to obtain maximum command.
- ii. So far as possible the canal alignment should be kept in the centre of the commanded area.
- iii. The canal should be aligned in such a way that the length is minimum possible.
- iv. The alignment should avoid inhabited places, roads, railways, properties, places of worship etc.
- v. Canal should be taken through the area where subsoil formation is favourable. Water logged, alkali, saline, rocky soils create troubles.
- vi. The alignment should be straight so far as possible. Where alignment is not straight simple circular curves of large radius should be provided.
- vii. To ensure economy the alignment of the canal should be such that excessive cuttings and fillings are not required. The alignment should not cross hills or depressions.

### Canal Linings

Canal Linings are provided in canals to resist the flow of water through its bed and sides. These can be constructed using different materials such as compacted earth, cement, concrete, plastics, boulders, bricks etc. The main advantage of canal lining is to protect the water from seepage loss.

Canal Lining is an impermeable layer provided for the bed and sides of canal to improve the life and discharge capacity of canal. 60 to 80% of water lost through seepage in an unlined canal can be saved by construction canal lining.

### Types of Canal Linings

Canal linings are classified into two major types based on the nature of surface and they are:

1. Earthen type lining
2. Hard surface lining



## **1. Earthen Type lining**

Earthen Type linings are again classified into two types and they are as follows:

- i. Compacted Earth Lining
- ii. Soil Cement Lining

### **Compacted Earth Lining**

Compacted earth linings are preferred for the canals when the earth is available near the site of construction or In-situ. If the earth is not available near the site then it becomes costlier to construct compacted earth lining.

Compaction reduces soil pore sizes by displacing air and water. Reduction in void size increases the density, compressive strength and shear strength of the soil and reduces permeability. This is accompanied by a reduction in volume and settlement of the surface. Proper compaction is essential to increase the stability and frost resistance (where required) and to decrease erosion and seepage losses.

### **Soil Cement Lining**

Soil-cement linings are constructed with mixtures of sandy soil, cement and water, which harden to a concrete-like material. The cement content should be minimum 2-8% of the soil by volume. However, larger cement contents are also used.

In general, for the construction of soil-cement linings following two methods are used.

Dry-mix method

Plastic mix method

For erosion protection and additional strength in large channels, the layer of soil-cement is sometimes covered with coarse soil. It is recommended the soil-cement lining should be protected from the weather for seven days by spreading approximately 50 mm of soil, straw or hessian bags over it and keeping the cover moistened to allow proper curing. Water sprinkling should continue for 28 days following installation.

## **2. Hard Surface Canal Linings**

It is sub divided into 4 types and they are

- i. Cement Concrete Lining
- ii. Brick Lining
- iii. Plastic Lining
- iv. Boulder Lining

### **Cement Concrete Lining**

Cement Concrete linings are widely used, with benefits justifying their relatively high cost. They are tough, durable, relatively impermeable and hydraulically efficient. Concrete linings are suitable for both small and large channels and both high and low flow velocities. They fulfill every purpose of lining.

There are several procedures of lining using cement concrete

- i. Cast in situ lining
- ii. Shotcrete lining
- iii. Precast concrete lining
- iv. Cement mortar lining

### **Brick Lining**

In case of brick lining, bricks are laid using cement mortar on the sides and bed of the canal. After laying bricks, smooth finish is provided on the surface using cement mortar.

### **Plastic Lining**

Plastic lining of canal is newly developed technique and holds good promise. There are three types of plastic membranes which are used for canal lining, namely:

- a) Low density poly ethylene
- b) High molecular high density polythene
- c) Polyvinyl chloride

The advantages of providing plastic lining to the canal are many as plastic is negligible in weight, easy for handling, spreading and transport, immune to chemical action and speedy construction.

The plastic film is spread on the prepared sub-grade of the canal. To anchor the membrane on the banks 'V' trenches are provided. The film is then covered with protective soil cover.

### **Boulder Lining**

This type of lining is constructed with dressed stone blocks laid in mortar. Properly dressed stones are not available in nature. Irregular stone blocks are dressed and chipped off as per requirement.

When roughly dressed stones are used for lining, the surface is rendered rough which may put lot of resistance to flow. Technically the coefficient of rugosity will be higher. Thus the stone lining is limited to the situation where loss of head is not an important consideration and where stones are available at moderate cost.

### **Advantages of Canal Lining**

1. Seepage Reduction
2. Prevention of Water Logging
3. Increase in Commanded Area
4. Increase in Channel Capacity
5. Less Maintenance

## 6. Safety Against Floods

### 1. Seepage Reduction

The main purpose behind the lining of canal is to reduce the seepage losses. In some soils, the seepage loss of water in unlined canals is about 25 to 50% of total water supplied. The cost of canal lining is high but it is justifiable for its efforts in saving of most of the water from seepage losses. Canal lining is not necessary if seepage losses are very small.

### 2. Prevention of Water Logging

Water logging is caused due to phenomenal rise in water table due to uncontrolled seepage in an unlined canal. This seepage effects the surrounding ground water table and makes the land unsuitable for irrigation. So, this problem of water logging can be surely prevented by providing proper lining to the canal sides.

### 3. Increase in Commanded Area

Commanded area is the area which is suitable for irrigation purpose. The water carrying capacity of lined canal is much higher than the unlined canal and hence more area can be irrigated using lined canals.

### 4. Increase in Channel Capacity

Canal lining can also increase the channel capacity. The lined canal surface is generally smooth and allows water to flow with high velocity compared to unlined channel. Higher the velocity of flow greater is the capacity of channel and hence channel capacity will increase by providing lining.

On the other side with this increase in capacity, channel dimensions can also be reduce to maintain the previous capacity of unlined canal which saves the cost of the project.

### 5. Less Maintenance

Maintenance of lined canal is easier than unlined canals. Generally there is a problem of silting in unlined canal which removal requires huge expenditure but in case of lined canals, because of high velocity of flow, the silt is easily carried away by the water.

In case of unlined canals, there is a chance of growth of vegetation on the canal surface but not in case of lined canals. The vegetation affect the velocity of flow and water carrying capacity of channel. Lined canal also prevents damage of canal surface due to rats or insects.

### 6. Safety against Floods

A line canal always withstand against floods while unlined canal may not resists and also there is chance of occurring of breach which damages the whole canal as well as surrounding areas or fields. But among the all concrete canal linings are good against floods or high velocity flows.

#### **Kennedy's Silt Theory**

RG Kennedy investigated canals systems for twenty years and come up with a Kennedy's silt theory. The theory says that, the silt carried by flowing water in a channel is kept in suspension by the eddy current rising to the surface.

The vertical component of the eddy current tries to move sediment up whereas sediment weight tries to bring it down. Therefore, if adequate velocity available to create eddies so as to keep the sediment just in suspension silting will be prevented.

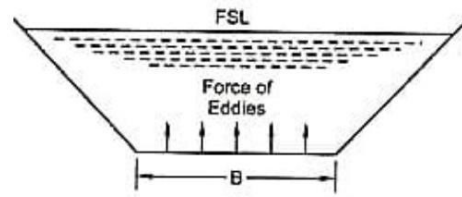

Fig.1: Eddies force according to Kennedy's silt theory

### Assumptions regarding Kennedy's Silt Theory

The eddy current is generated because of friction between flowing water and the roughness of the canal bed.

The quantity of the suspended silt is proportional to bed width.

The theory is applicable to those channels which are flowing through the bed consisting of sandy silt or same grade of silt.

### Critical velocity based on Kennedy's Silt Theory

Critical velocity is the mean velocity which will just make the channel free from silting and scouring. The velocity is based on the depth of the water in the channel. The general form of critical velocity is as follow:Where

$$V_o = C D^n \text{-----} (1)$$

$V_o$  = Critical velocity

$D$  = full supply depth

$C$  &  $n$ : Constants which found to be 0.546 and 0.64, respectively.

Thus, Equation 1 rewritten as follow:

$$V_o = 0.546 D^{0.64} \text{-----} (2)$$

Moreover, Equation 2 further improved upon realization that silt grade influences critical velocity. So, a factor termed as critical velocity ratio introduced and the equation became as follows:

$$V_o = 0.546 m D^{0.64} \text{-----} (2)$$

Where

$m$ : critical velocity ratio which equal to actual velocity ( $V$ ) divided by critical velocity ( $V_o$ ), value of  $m$  provided in Table 1.

Table 1 Values of  $m$  based on the type of silt

Channel lining	N values
Earth	0.0225
Masonry	0.02
Concrete	0.013 to 0.018

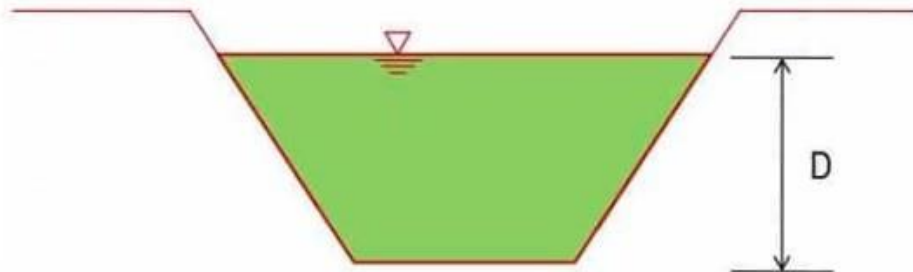

Fig.2: Depth of water in canal

### Limitations of Kennedy's Silt Theory

Trial and error method used for the canal design using Kennedy's Silt Theory.

There is no equation for bed slope assessment, so the equation developed by Kutter used to compute bed slope.

The ratio of channel width (B) to its depth (D) has no significance in Kennedy's Silt Theory.

There is not perfect definition for salt grade and salt charge.

Complex phenomenon of silt transportation is not fully accounted and only critical velocity ratio (m) concept is considered sufficient.

### Procedure of Canal design using Kennedy's Silt Theory

There are two cases of canal design using Kennedy's Silt Theory dependent on the given data. Both cases presented below:

#### Case 1

The following data shall be available before hand:

discharge (Q), rugosity coefficient (N), Critical velocity ratio (m) and bed slope of the channel (s).

1. Assume suitable full supply depth (D).
2. Then, find the mean velocity by using Kennedy's equation (Equation 3).
3. After that, find the area of cross section by using continuity equation:Where:

$$Q = A V$$

Q: Discharge

A: cross section area

V: mean velocity computed in step 2

4. Assume the shape of channel section with side slopes (0.5V:1H)
5. Find out the value of base width of channel (B).
6. Then, find the perimeter of the channel (P). Which helps to find out the hydraulic mean depth of channel (R).

$$R = A/P \quad \text{Equation 5}$$

Where:

R: hydraulic mean depth

A: canal cross section area

P: perimeter of the section

7. Finally, calculate the mean velocity (V) using kutter's formula:

$$V = \left( \frac{1/N(23+0.00155/s)}{1+(23+0.00155/s)(N/\sqrt{R})} \right) \sqrt{Rs} \quad \text{Equation 6}$$

Where:

N: rugosity coefficient based on type of canal lining material. Table 2 provide N values for different lining condition.

S: bed slope as 1 in 'n'.

Both the values of V computed using equation 3 and V computed employing equation 6 must be the same. Otherwise repeat the above procedure by assuming another value of D.

Generally, the trial depth is assumed between 1 m to 2 m. If the condition is not satisfied within this limit, then it may be assumed accordingly.

Table 2 N values based on the channel lining material

Channel lining	N values
Earth	0.0225
Masonry	0.02
Concrete	0.013 to 0.018

## Case 2

When discharge (Q), rugosity coefficient (N), Critical velocity ration (m) and B/D ratio are given.

1. Assume  $B/D = X$
2. By using the Kennedy's equation find "V" in terms of D.
3. Find the area of cross section of the channel in terms of D<sup>2</sup>.
4. By using continuity Equation 4, find the value of D. and then Find the base width (B).
5. Find hydraulic mean depth (R) with Equation 5.
6. Finally, find the value of "V" using Equation 3.
7. Substitute the value of V in step 6 in Equation 6 will gives the longitudinal slope of the channel (S). This case will done by trial and error method.

### Lacey's Silt Theory of Canals

Lacey investigated the stability conditions of different alluvial channels and came up with Lacey's silt theory which explains about the different regime conditions of a channel such as true regime, initial regime, and final regime and the design procedure of canal.

Lacey stated that a channel may not be in regime condition even if it is flowing with non-scouring and non-silting velocity. Therefore, he distinguished three regime conditions as follows :

1. True regime
2. Initial Regime
3. Final Regime

#### 1. True regime

A channel is said to be in regime condition if it is transporting water and sediment in equilibrium such that there is neither silting nor scouring of the channel. But according to Lacey, the channel should satisfy the following conditions to be in regime condition.

1. Canal discharge should be constant.
2. The channel should flow through incoherent alluvium soil, which can be scoured as easily as it can be deposited and this sediment should be of the same grade as is transported.
3. Silt grade should be constant.
4. Silt charge, which is the minimum transported load should be constant.

If the above conditions are satisfied, then the channel is said to be in true regime condition. But this is not possible in actual practice. Hence lacey defined two other conditions which are initial and final regime conditions.

#### 2. Initial Regime

A channel is said to be in initial regime condition when only the bed slope of channel gets affected by silting and scouring and other parameters are independent even in non-silting and non-scouring velocity condition. It may be due to the absence of incoherent alluvium. According to Lacey's, regime theory is not applicable to initial regime condition.

### 3. Final Regime

If the channel parameters such as sides, bed slope, depth etc. are changing according to the flow rate and silt grade then it is said to be in final regime condition. The channel shape may vary according to silt grade as shown in the figure below :

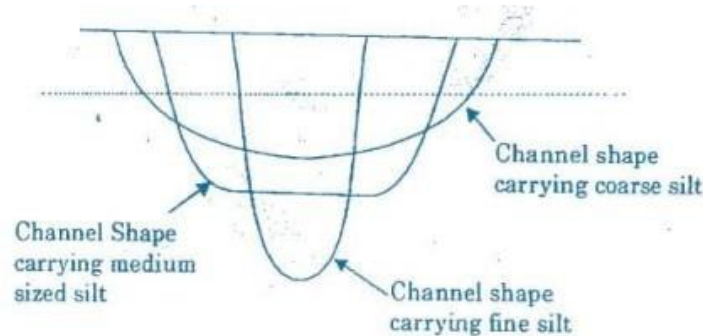

Fig 2: Channel Shape vs Silt Grade

Lacey's specified that the regime theory is valid for final regime condition only and he also specified that semi-ellipse is the ideal shape of regime channels.

### Canal design using Lacey's Silt Theory

According to Lacey's, the design procedure to build canal is as follows :

Canal discharge (Q) and mean particle size (dm) should be known.

From the mean size or diameter of the particle (dm), silt factor is first calculated using the below expression :

$$\text{Silt factor, } f = 1.76 \sqrt{d_m}$$

Silt factor values for different types of soils are tabulated here.

S.No	Soil Type	Silt Factor, f
1	Fine silt	0.5 – 0.7
2	Medium silt	0.85
3	Standard silt	1
4	Medium sand	1.25
5	Coarse sand	1.5

Using discharge and silt factor, velocity (V) can be calculated by the expression as follows :



Velocity of flow *Velocity of flow, V* =  $\left[\frac{Qf^2}{140}\right]^{1/6}$

After attaining the velocity of canal flow, find the area of the canal by dividing discharge with velocity. Also, find the mean hydraulic depth (R) of the canal and wetted perimeter (P) of the canal.

$$\text{Area} = \frac{Q}{V}$$

$$\text{Hydraulic Mean Depth, } R = \frac{5V^2}{2f}$$

$$\text{Wetted Perimeter, } P = 4.75\sqrt{Q}$$

Assume the bed slope (S) value or find by substituting the values of silt factor and canal discharge in the following formula :

$$\text{Bed slope, } S = \frac{f^{5/3}}{3340Q^{1/6}}$$

#### **Drawbacks of Lacey's Silt Theory**

- Lacey did not explain the properties that govern the alluvial channel.
- In general, flow is different at bed and sides of the channel which requires two different silt factors but Lacey derived only one silt factor.
- The semi-elliptical shape proposed by Lacey as the ideal shape of the channel is not convincing.
- Lacey did not consider the silt concentration in his equations.
- Attrition of silt particles is ignored by Lacey.
- Lacey did not give proper definitions for the silt grade and silt charge.

\*\*\*\*\*

## UNIT – 4

### **WATER MANAGEMENT IN IRRIGATION**

Modernization techniques- Rehabilitation – Optimization of water use-Minimizing water losses- On farm development works-Participatory irrigation management- Water resources associations- Changing paradigms in water management-Performance evaluation-Economic aspects of irrigation.

#### **Modernization techniques**

- Improving irrigation water management, in order to increase productivity and minimize adverse effects such as salinization, is one of the main contemporary issues in the agricultural sector.
- A considerable effort is being made to improve irrigation operations and to reduce costs.
- Society in general and water user associations, particularly where they have to bear the cost of irrigation, are demanding that irrigation become more cost-effective.

**Rehabilitation**, which consists of re-engineering a deficient infrastructure to return it to the original design. Although rehabilitation usually applies to the physical infrastructure, it can also concern institutional arrangements.

**Process improvement**, which consists of intervening in the process without changing the rules of the water management. For instance, the introduction of modern techniques is a process improvement.

**Modernization**, which is a more complex intervention implying fundamental changes in the rules governing water resource management. It may include interventions in the physical infrastructure as well as in its management.

#### **Defining modernization**

Irrigation modernization is a process of technical and managerial upgrading (as opposed to mere rehabilitation) of irrigation schemes combined with institutional reforms, with the objective to improve resource utilization (labour, water, economic, environmental) and water delivery service to farms.

## **The need for a consistent framework for modernization**

- Increasing water productivity
- Increasing the cost-effectiveness
- Increasing the reliability in irrigation deliveries.
- Increasing the flexibility of deliveries.
- Consideration of other uses of water
- Increasing knowledge and human resources development

## **Obstacles in the way of modernization**

Successful modernization is not straightforward, and failure to achieve targeted performance objectives, in some instances, requires further investigation of the underlying causes. As far as the technology is concerned, significant hardware and software progress has been made in irrigation system operations in the past decade, including computer facilities, information techniques, measurements, and canal control concepts

**Technical gaps** between the requirements needed to implement the improved method (availability of expertise, technical maintenance of equipment) and available local resources.

**Financial constraints** resulting from the gap between the cost of equipment for the improved method and the gain in water savings and improved services, as water is generally not priced or charges are low.

**Social constraints.** Human resources are relatively less expensive in developing economies than alternative technological solutions. An irrigation agency, often a large employer in the area, has some obligation to maintain local staff.

**Institutional constraints.** Bureaucratic centralized irrigation administrations are not well suited to service-oriented activities.

## **Model for the modern irrigation enterprise**

- It is clear for many that the irrigation sector in general has not reached the same level of effectiveness as other sectors, such as the industrial and service sectors.
- Hence modernization can be seen as a means to create and favour modern irrigation enterprises by introducing methodologies which have proved successful in other sectors.
- We advocate that modern enterprises in irrigation require a reengineering of their processes in order to cope with the new challenges faced by irrigation.

## **Reengineering irrigation system operations**

The reengineering of the irrigation operation should consist of designing the most cost-effective answer to the redefined water service within the scheme. It should consider:

**The spatial distribution of the effective demand for the water service.** The service might differ significantly with user demand, e.g. cash-crop farmers might ask for a high quality and costly service whereas farmers with an alternative source (wells) might be satisfied with a low and cheap service. The service might also differ because of other considerations such as hydrological hazards (salinization, water-logging) and opportunities (recycling of water).

**The spatial distribution of the physical infrastructure characteristics.** The sensitivity of the canal delivery structures, the efficiency in controlling water depth, the ease of monitoring and implementing operation - these are some of the important features that should be considered when designing an appropriate answer to meet the demand.

## **Flexibility in modernization**

The concept of flexibility has long been discussed and advocated in the field of irrigation modernization.

So far it has encompassed the notion of flexibility in water deliveries as opposed to rotational and fixed deliveries.

Flexible deliveries can be proposed to users in different forms (on request, free access, etc) at a cost compared to a strict rotational distribution.

This concept of flexibility leads to abandoning the homogeneous approach of irrigation systems that has so far prevailed.

Instead, a heterogeneous approach of the demand and of the efforts (inputs) to operate irrigation systems is sought for a closer match of water availability to demand requirements.

**Modernization** is a never-ending process of adapting activities to current constraints and objectives. The agricultural and economic contexts are permanently evolving and so are the demands from society. What was modern and up to date some decades ago might now appear to be incompatible with current needs, and this is not only true of the technical aspects of irrigation.

## **Low-cost technologies**

The introduction of low-cost technologies, which could be part of the modernization of small-scale irrigation projects, provides another example of the site-specificity of success.

Inexpensive treadle pumps have been successful in some South Asian countries in extracting irrigation water from shallow aquifers.

These pumps have allowed poor farmers to make good use of the available labour in their households and so increase crop production and farm income.

The farmer has full control over the timing and amount of this pumped water, which given the effort involved is used sparingly.

For example, the area under irrigation by one treadle pump in West Bengal, India, varies between 0.033 and 0.13 ha. Treadle pumps have also been introduced in Africa, including the urban and peri-urban areas of Ndjamena, Chad. Here, the vegetable growers rejected the pumps in favour of mechanical pumps because they could afford the cost of fuel and spare parts.

### **Bucket drip-irrigation kits**

Positive experience has been reported with the introduction of bucket drip-irrigation kits. These kits are suitable for the irrigation of small plots of vegetables and fruit trees in peri-urban areas (close to markets). In Kenya, the return on an investment of about US\$15 for one bucket drip-irrigation kit was some US\$20 per month. Farmers in Kenya have bought over 10 000 kits, although some of these farmers could not be described as very poor.

**Rehabilitation** - the renovation of a scheme to meet its original design criteria

- Inadequate operational practices may limit improvements to water supply expected from improved infrastructure.
- Trained and motivated operational staff are needed. They must be committed to delivering a specified minimum level of service. Institutional will and government policies are needed to effect such changes.
- Farmers must be willing and able to exploit a better supply. They may need training in water use and maintenance. A formal or informal water user group must exist.
- Until the water supply is improved, it is unlikely that farmers will cooperate.

**Maintenance activities in a reservoir itself comprise:**

- controlling aquatic weeds,
- removing large debris (e.g. tree trunks) floating in the water that may damage hydraulic works,
- monitoring the water quality: not only from the salt content point of view but also from a biological standpoint in order to detect possible sources of pollution
- surveying the solid deposition in the bottom of a reservoir.

**The retention in good working order of open drains includes the following operations:**

1. light deforestation
2. weed control in the canal section
3. seeding grass in the canal section

4. maintenance of flow gauges and other measuring devices
5. removal of silt
6. maintenance of pumping stations where water cannot be evacuated by gravity.

### **Optimization of water use**

Water efficiency of irrigation can be improved by making the right decisions regarding:

- Crop selection
- Irrigation scheduling
- Irrigation methods
- Source of water.

### **Improving Irrigation practices can:**

- Reduce water and pumping costs
- Reduce costs for fertilizers and other agricultural chemicals
- Maintain a higher soil quality
- Increase crop yields – by as much as 100%

### **Irrigation scheduling**

- Irrigation scheduling helps eliminate or reduce instances where too little or too much water is applied to crops.
- Scheduling is performed by all growers in one way or another.
- However, proper irrigation scheduling involves fine-tuning the time and amount of water applied to crops based on the water content in the crop root zone, the amount of water consumed by the crop since it was last irrigated, and crop development stage.
- Direct measurement of soil moisture content is among the most useful methods for irrigation scheduling.

### **Good irrigation scheduling requires knowledge of:**

- Crop water demand at different growth cycles
- Moisture content of the soil and soil water capacity
- Weather conditions.

## **Soil capacity**

- **Soil capacity**, which is the ability of the soil to hold water between irrigation or precipitation events, is another important factor.
- Determinants of soil capacity include soil depth, ratios of different soil particles making up the soil, soil porosity, and soil water tension.

## **Climatic conditions**

The prevailing **climatic conditions**, such as average ambient temperature, intensity of solar radiation, humidity, and windspeed also affect both the moisture retained in the soil and the speed by which plants lose water through transpiration.

## **Accurate monitoring**

- Accurate monitoring of water used in irrigation is an essential part of irrigation scheduling and helps reach optimal performance, saving water while enhancing yields.
- Accurate readings can be obtained through different direct measurement methods available for pipes and closed conduits
- Measurement of energy used by irrigation pumps
- End-pressure measurements in sprinkler irrigation
- Elevation differences in irrigation reservoirs or tanks
- Measurement of irrigation time and size of irrigation delivery system.

## **IRRIGATION METHODS**

Once the quantitative and temporal characteristics of optimal water demand have been determined, a method that can make such water available in the most effective way should be selected. There are three main irrigation methods, namely:

1. Surface (or gravity) irrigation
2. Sprinkler irrigation
3. Drip irrigation.

### **Water losses be control:**

The following are the measures that are generally taken to control the water losses from the reservoir.

#### **1. Measure to Reduce Evaporation Loss**

- a) The reservoir should be constructed of less surface area and more depth.
- b) Tall trees should be grown on the windward side of the reservoir which act as wind breakers and hence the rate of evaporation will be reduced.

c) The reservoir basin should be surrounded by plantation or forest area so that cooler environment exists within the reservoir area.

d) Certain chemical like cetyl alcohol is spread over the reservoir surface. It forms a thin film on water surface reducing evaporation.

## **2. Measure to Reduce Absorption Loss**

a) The weeds and plants at the periphery of the reservoir should be removed completely.

b) The weeds from the surface of the reservoir should be removed.

## **3. Measure to Reduce Percolation Loss**

a) Geological investigations should be carried out to locate the zones of pervious formations, cracks and fissures in the bed and periphery of the reservoir basin.

b) Suitable treatments should be adopted to stop the leakage of water through these zones.

c) Soil stabilization methods should be adopted if the basin is composed of permeable bed soil.

## **Water logging**

- In agricultural land, when the soil pores within the root zone of the crops get saturated with the subsoil water, the air circulation within the soil pores gets totally stopped.
- This phenomenon is termed as water logging.
- The water logging makes the soil alkaline in character and the fertility of the land is totally destroyed and the yield of crop is reduced.

## **Effects of water logging**

The following are the effects of water logging:

- Stabilization of soil
- Lack of aeration
- Fall of soil temperature
- Growth of weeds and aquatic plants
- Diseases of crops
- Difficulty in cultivation
- Restriction of root growth

## **Methods used for controlling water logging**

The following measures may be taken to control water logging:

- Prevention of percolation from canals
- Prevention of percolation from reservoirs
- Control of intensity of irrigation
- Economical use of water
- Fixing of crop pattern
- Providing drainage system



- Improvement of natural drainage
- Pumping of ground water
- Construction of sump well

### **ON FARM DEVELOPMENT WORKS (OFD)**

- The efficient management of irrigation water for maximizing productivity requires both, the efficient on farm water management and the optimization of the use of water and land, through appropriate methods of water application.
- The efficient on-farm water management is related to water delivery system and allied works in the command area of chak (Small irrigation block), which distributes the water to each farm.
- The items of works pertaining to on farm water management are termed as “On farm development works”.

The on farm development works comprise of following,

- a) Field channels for conveyance of water
- b) Control structures
- c) Crossings
- d) Surface drainage system
- e) Farm roads
- f) Field channel protection works and
- g) Land forming (Smoothing / grading / leveling).

### **Systems approach:**

- The conveyance system from the dam to the farm gate is one live system and it is necessary that the designs of the different components are matched properly.
- The water management proposed to be adopted on the canal system should always be kept in view as a reference frame.

### **Sequence of design and execution:**

- (a) The ideal sequence of finalization of design would be obviously from the tail to the head.
  - First, according to the topography and soil conditions, the land forming of each farm would be decided, so as to ensure efficient irrigation.
  - Next, the chak water delivery system and surface drains would be designed so as to ensure adequate water deliveries to the different farms and proper drainage.
- (b) The execution of OFD works shall be done only in places where canal water has actually reached. The OFD works get disturbed and deteriorated if these are not put to use immediately.
- (c) After construction of OFD works, preparation of work-done drawings of OFD works (record drawings) form the basic record for planning irrigation management.

**Functional utility:**

- The purpose of the OFD works is to provide timely and adequate supplies of water to each holding and preserve environmental balance as well, by avoiding seepages, leakages and stagnations of water which trigger problems like water logging, causing adverse impact on environment.
- To achieve this functional utility, the planning and design of OFD works has to be hydraulically better and socially acceptable.

The functional utility of OFD works is governed by following aspects

- i. Hydraulic design
- ii. Economy for construction and maintenance
- iii. Social acceptance i.e. User friendliness to community of farmers who will be actually using OFD works and
- iv. Levels of accuracies and quality of construction. These issues need to have a proper bearing in approach to design and execution of OFD works.

**Farmers Participation:**

- Success of canal irrigation depends on the response of the farmer, both as an individual and as a member of the group benefited by the outlet.
- The irrigation facilities should be designed with a view to meet his requirements, particularly in respect of land forming.
- Active participation of the farmer at the stage of design should therefore be encouraged.
- This will also help in building up of an atmosphere of common purpose and thereby in the unification of the beneficiaries into a homogeneous group.

**Organizational Coordination:**

- The works from the canal head down to the distributory and from the distributory head to the outlet are carried out by the Construction Organization (C.O.) of the Irrigation Department.
- The outlet of a capacity of about 30 litre/second is the last Government structure on the canal system. Below outlet, OFD works are the community works.
- Design and construction proceed on the basis of the location of the outlet and its sill level.

**Procedure for taking up OFD works:**

The OFD works are part of CAD works. The cost estimates for OFD works are generally formulated in two parts.

**a) Part I works :** Cost estimates for chak water delivery system, field channel protection works and surface drainage works in a chak.

**b) Part II :** Cost estimate for land forming works for each holding.

## **Participatory irrigation management**

- The term participatory irrigation management (PIM) refers to the participation of irrigation users, i.e., farmers, in the management of irrigation systems not merely at the tertiary level of management but spanning the entire system.
- Participation should not be construed as consultation alone. The concept of PIM refers to management by irrigation users at all levels of the system and in all aspects of management. This is the simplicity and flexibility of PIM.
- There can be different forms of participation at different levels in the system with varying degrees of accountability and responsibility.
- Management by irrigation users, rather than by a government agency, is often the best solution.
- Contrary to the traditional concept that irrigation management requires a strong public-sector role, the PIM approach starts with the assumption that the irrigation users themselves are best suited to manage their own water.
- "Participation in irrigation management involves a larger role for farmers, water groups, and other stakeholders.
- It may range from offering information and opinions during consultations, to fully enabling farmers to act as principal decision makers in all or most project activities.
- There have been increasing efforts to use participation in various forms to improve the quality, effectiveness, and sustainability of irrigation systems.
- This makes it important to learn what has and has not been achieved in efforts to improve participation in irrigation management.
- Farmers' participation in irrigation management is not entirely new to India. There is considerable evidence that farmers in pre-independence years had been involved in irrigation management in different parts of the country.
- The phad system of Nasik and Dhule districts and the Malgajari tanks of Chandrapur and Bhandara districts in Maharashtra, the Ahar-Pyne system of Bihar, the Kuhl system of H.P. and the Kudimaramath of Tamilnadu are some of the important examples of PIM under traditional irrigation.
- Vestiges of these practices still survive though these have become quite weak or even extinct with the passage of time.
- A few formal water users associations were also formed from time to time like the Vadakku Kodai Melazhahian Channel Land Holders Association in Tamilnadu in December 1959, Malinagar Irrigators' Water Cooperative Society in Maharashtra in 1967, Vaishali Area Small Farmers Association in Bihar in 1971, Mohini Water Cooperative Society in Gujarat in 1978.
- These were, however, isolated examples which could be counted on fingers. Irrigation management from top to bottom remained concentrated in the hands of the government.

- It may be said that since 1972, after the establishment of CADA, a large number of farmer organisations at the outlet level were formed under the CAD projects.
- These were variously described as pipe committees, outlet committees and WUAs. These, however, lacked authority and responsibility and, therefore, could not serve any useful purpose. Many of these became non-functional after some time.